

Owner's Identification

OWNER _____

ADDRESS _____
STREET

CITY STATE/PROVINCE/TERRITORY ZIP CODE/
POSTAL CODE

V. I. N. _____

DELIVERY DATE _____
(Date sold to original retail purchaser)

DEALER NAME _____ DEALER NO. _____

ADDRESS _____
STREET

CITY STATE/PROVINCE/TERRITORY ZIP CODE/
POSTAL CODE

OWNER'S SIGNATURE _____

DEALER'S SIGNATURE _____

This owner's manual should be considered a permanent part of the vehicle and should remain with the vehicle when it is sold.

This Owner's Manual covers all models of the MDX. You may find descriptions of equipment and features that are not on your particular model.

Images throughout this owner's manual (including the front cover) represent features and equipment that are available on some, but not all, models. Your particular model may not have some of these features.

The information and specifications included in this publication were in effect at the time of approval for printing. Honda Motor Co., Ltd. reserves the right, however, to discontinue or change specifications or design at any time without notice and without incurring any obligation whatsoever.

**POUR CLIENTS CANADIEN
AVIS IMPORTANT: Si vous avez
besoin d'un Manuel du Conducteur
en français, veuillez demander à
votre concessionnaire de
commander le numéro de pièce
33STXC50**

Congratulations! Your selection of a 2012 Acura MDX was a wise investment. It will give you years of driving pleasure.

One of the best ways to enhance the enjoyment of your new vehicle is to read this manual. In it, you will learn how to operate its driving controls and convenience items. Afterwards, keep this owner's manual in your vehicle so you can refer to it at any time.

Several warranties protect your new vehicle. Read the warranty booklet thoroughly so you understand the coverages and are aware of your rights and responsibilities.

Maintaining your vehicle according to the Maintenance Minder™ shown in the instrument panel helps to keep your driving trouble-free while it preserves your investment. When your vehicle needs maintenance, keep in mind that your dealer's staff is specially trained in servicing the many systems unique to your vehicle. Your dealer is dedicated to your satisfaction and will be pleased to answer any questions and concerns.

As you read this manual, you will find information that is preceded by a **NOTICE** symbol. This information is intended to help you avoid damage to your vehicle, other property, or the environment.

Introduction

Event Data Recorders

This vehicle is equipped with an event data recorder (EDR).

The main purpose of an EDR is to record, in certain crash or near crash-like situations, such as an air bag deployment or hitting a road obstacle, data that will assist in understanding how a vehicle's systems performed. The EDR is designed to record data related to vehicle dynamics and safety systems for a short period of time, typically 30 seconds or less. The EDR in this vehicle is designed to record such data as:

- How various systems in your vehicle were operating;
- Whether or not the driver and passenger safety belts were buckled/fastened;
- How far (if at all) the driver was depressing the accelerator and/or brake pedal; and,
- How fast the vehicle was traveling.

These data can help provide a better understanding of the circumstances in which crashes and injuries occur. NOTE: EDR data are recorded by your vehicle only if a non-trivial crash situation occurs; no data are recorded by the EDR under normal driving conditions and no personal data (e.g., name, gender, age, and crash location) are recorded. However, other parties, such as law enforcement, could combine the EDR data with the type of personally identifying data routinely acquired during a crash investigation.

To read data recorded by an EDR, special equipment is required, and access to the vehicle or the EDR is needed. In addition to the vehicle manufacturer, other parties, such as law enforcement, that have the special equipment, can read the information if they have access to the vehicle or the EDR.

The data belongs to the vehicle owner and may not be accessed by anyone else except as legally required or with the permission of the vehicle owner.

California Proposition 65 Warning

WARNING: This product contains or emits chemicals known to the State of California to cause cancer and birth defects or other reproductive harm.

Service Diagnostic Recorders

This vehicle is equipped with service-related devices that record information about powertrain performance. The data can be used to verify emissions law requirements and/or help technicians diagnose and solve service problems. It may also be combined with data from other sources for research purposes, but it remains confidential.

California Perchlorate Contamination Prevention Act

The airbags, seat belt tensioners, and CR type batteries in this vehicle may contain perchlorate materials - special handling may apply. See www.dtsc.ca.gov/hazardouswaste/perchlorate/

A Few Words About Safety

Your safety, and the safety of others, is very important. And operating this vehicle safely is an important responsibility.

To help you make informed decisions about safety, we have provided operating procedures and other information on labels and in this manual. This information alerts you to potential hazards that could hurt you or others.

Of course, it is not practical or possible to warn you about all the hazards associated with operating or maintaining your vehicle. You must use your own good judgement.

You will find this important safety information in a variety of forms, including:

- **Safety Labels** – on the vehicle.
- **Safety Messages** – preceded by a safety alert symbol  and one of three signal words: **DANGER**, **WARNING**, or **CAUTION**.

These signal words mean:

 **DANGER**

You **WILL** be **KILLED** or **SERIOUSLY HURT** if you don't follow instructions.

 **WARNING**

You **CAN** be **KILLED** or **SERIOUSLY HURT** if you don't follow instructions.

 **CAUTION**

You **CAN** be **HURT** if you don't follow instructions.

- **Safety Headings** – such as Important Safety Reminders or Important Safety Precautions.
- **Safety Section** – such as Driver and Passenger Safety.
- **Instructions** – how to use this vehicle correctly and safely.

This entire book is filled with important safety information – please read it carefully.

Important Handling Information

Your MDX has higher ground clearance than a passenger vehicle designed for use only on pavement. Higher ground clearance has many advantages for off-highway driving. It allows you to travel over bumps, obstacles, and rough terrain. It also provides good visibility so you can anticipate problems earlier.

These advantages come at some cost. Because your vehicle is taller and rides higher off the ground, it has a high center of gravity. This means your vehicle can tip or roll over if you make abrupt turns. Utility vehicles have a significantly higher rollover rate than other types of vehicles. In a rollover crash, an unbelted person is significantly more likely to die than a person wearing a seat belt. As a reminder, make sure you and your passengers always wear seat belts.

For information on how to reduce the risk of rollover, read “Driving Guidelines” on page 440 of this manual and the *Off-Highway Driving Guidelines* section on page 500. Failure to operate your vehicle correctly might result in loss of control, a crash, or rollover.

Contents

Your Vehicle at a Glance (main controls) 3

Driver and Passenger Safety (seat belts, SRS, and child protection) 5

Instruments and Controls (indicators, gauges, multi-information display, dashboard, and steering column) 65

Features (climate control, audio, rear entertainment, steering wheel, security, cruise control, and other convenience items).. 181

Before Driving (fuel, vehicle break-in, and cargo loading)..... 421

Driving (engine and transmission operation) 439

Maintenance (minder, fluid checking, minor services, and vehicle storage) 505

Taking Care of the Unexpected (flat tire, Jump starting, overheating, and fuses)..... 549

Technical Information (vehicle specifications, tires, and emissions controls) 575

Warranty and Client Relations (U.S. and Canada only) (warranty and contact information)..... 593

Index..... I

Service Information Summary (fluid capacities and tire pressures) last page

INDEX

Overview of Contents

Contents

A convenient reference to the sections in this manual.

Your Vehicle at a Glance

A quick reference to the main controls in your vehicle.

Driver and Passenger Safety

Important information about the proper use and care of your vehicle's seat belts, an overview of the supplemental restraint system, and valuable information on how to protect children with child restraints.

Instruments and Controls

Explains the purpose of each instrument panel indicator and gauge, and how to use the controls on the dashboard and steering column.

Features

How to operate the climate control system, the audio system, rear entertainment system, and other convenience features.

Before Driving

What gasoline to use, how to break-in your new vehicle, and how to load luggage and other cargo.

Driving

The proper way to start the engine, shift the transmission, and park; plus what you need to know if you're planning to tow a trailer.

Maintenance

The Maintenance Minder™ shows you when you need to take your vehicle to the dealer for maintenance service. There is also a list of things to check and instructions on how to check them.

Taking Care of the Unexpected

This section covers several problems motorists sometimes experience, and details how to handle them.

Technical Information

ID numbers, dimensions, capacities, and technical information.

Warranty and Client Relations (U.S. and Canada only)

A summary of the warranties covering your new vehicle, and how to contact us for any reason. Refer to your warranty manual for detailed information.

Index

Service Information Summary

A summary of the information you need when you pull up to the fuel pump.

Your Vehicle at a Glance

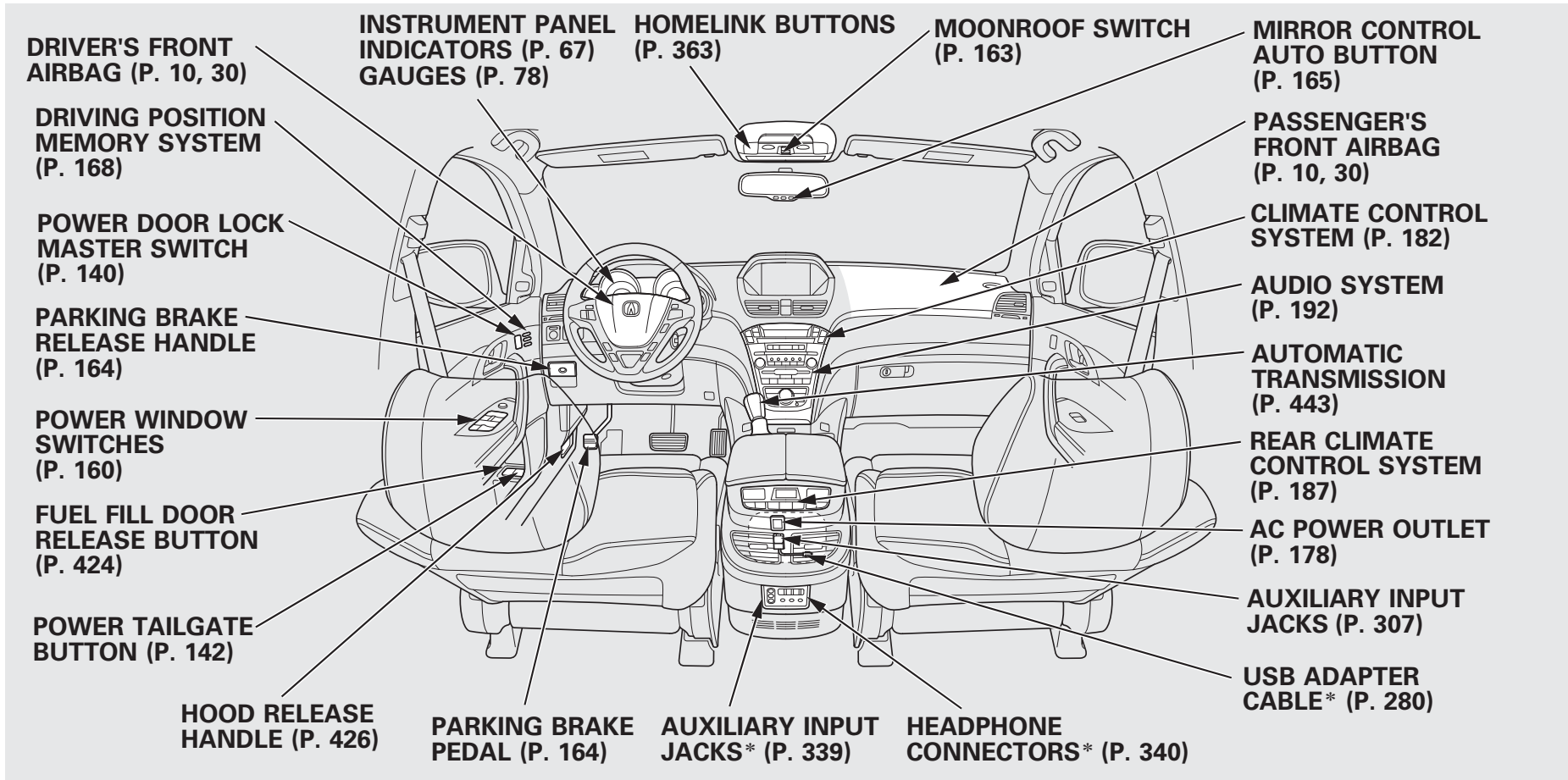

*: If equipped

CONTINUED

Your Vehicle at a Glance

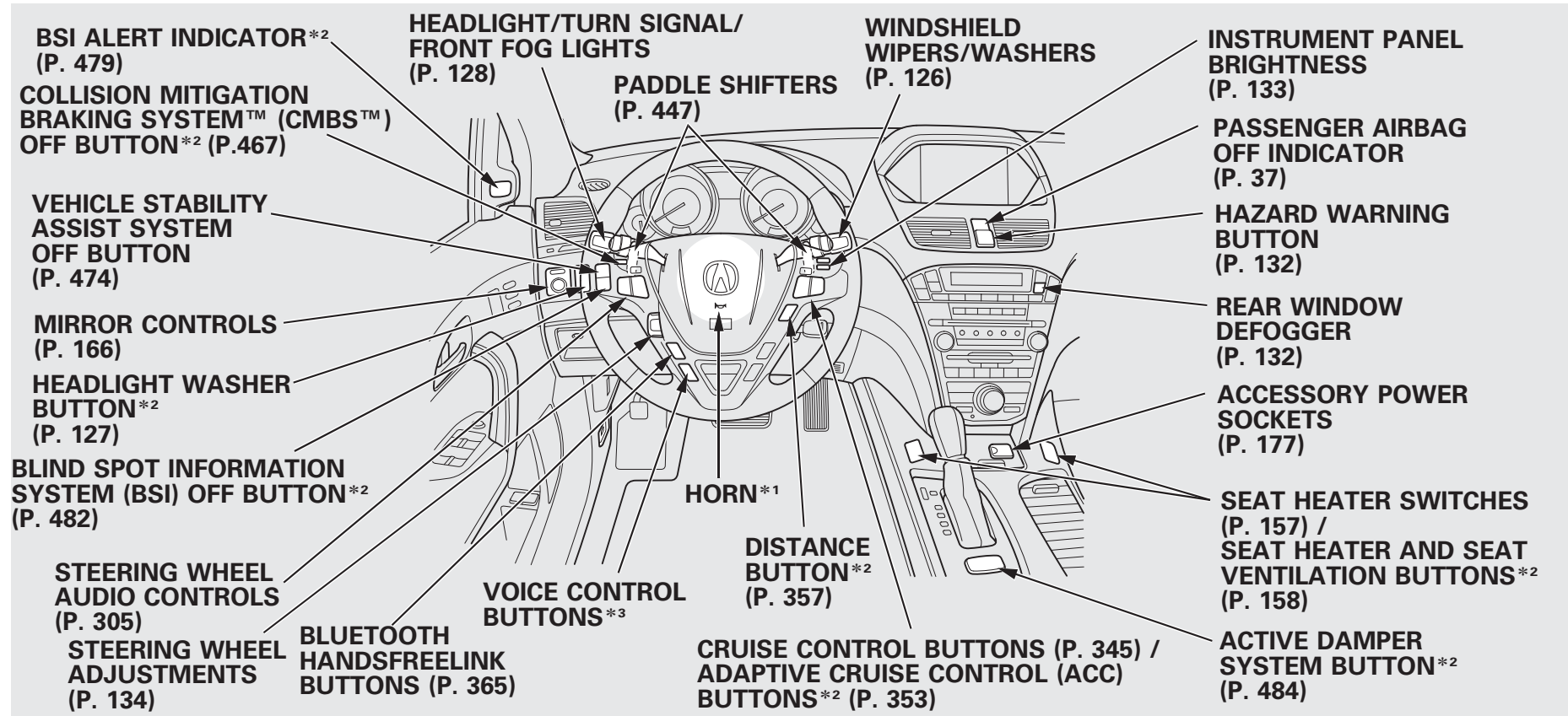

* 1: To use the horn, press the center pad of the steering wheel.

* 2: If equipped

* 3: Refer to the navigation system manual. For how to operate *Bluetooth*[®] HandsFreeLink by voice, see page 383.

This section gives you important information about how to protect yourself and your passengers. It shows you how to use seat belts. It explains how your airbags work. And it tells you how to properly restrain infants and children in your vehicle.

- Important Safety Precautions..... 6
- Your Vehicle's Safety Features..... 8
 - Seat Belts 9
 - Airbags 10
- Protecting Adults and Teens..... 12
 1. Close and Lock the Doors..... 12
 2. Adjust the Front Seats 14
 3. Adjust the Seat-Backs..... 15
 4. Adjust the Head Restraints..... 15
 5. Fasten and Position the Seat Belts 16
 6. Maintain a Proper Sitting Position 18
- Advice for Pregnant Women..... 19
- Additional Safety Precautions 20
- Additional Information About Your Seat Belts 21
- Seat Belt System Components 21

- Lap/Shoulder Belt..... 22
- Automatic Seat Belt Tensioners 23
- Seat Belt e-pretensioners..... 24
- Seat Belt Maintenance 25
- Additional Information About Your Airbags..... 27
 - Airbag System Components 27
 - How Your Front Airbags Work 30
 - How Your Side Airbags Work..... 33
 - How Your Side Curtain Airbags Work 35
 - How the SRS Indicator Works 36
 - How the Side Airbag Off Indicator Works..... 36
 - How the Passenger Airbag Off Indicator Works 37
 - Airbag Service 38
 - Additional Safety Precautions 39
- Protecting Children – General Guidelines 40
 - All Children Must Be Restrained 40
 - All Children Should Sit in a Back Seat 41
 - The Passenger's Front Airbag Can Pose Serious Risks 41

- If You Must Drive with Several Children..... 43
- If a Child Requires Close Attention 43
- Additional Safety Precautions 44
- Protecting Infants and Small Children 45
 - Protecting Infants..... 45
 - Protecting Small Children 46
- Selecting a Child Seat 48
- Installing a Child Seat 49
 - Installing a Child Seat with LATCH 50
 - Installing a Child Seat with a Lap/Shoulder Belt..... 53
 - Installing a Child Seat with a Tether..... 54
- Protecting Larger Children..... 57
 - Checking Seat Belt Fit 57
 - Using a Booster Seat 58
 - When Can a Larger Child Sit in Front..... 59
 - Additional Safety Precautions 60
- Carbon Monoxide Hazard 61
- Safety Labels 62

Important Safety Precautions

You'll find many safety recommendations throughout this section, and throughout this manual. The recommendations on this page are the ones we consider to be the most important.

Always Wear Your Seat Belt

A seat belt is your best protection in all types of collisions. Airbags are designed to supplement seat belts, not replace them. So even though your vehicle is equipped with airbags, make sure you and your passengers always wear your seat belts, and wear them properly (see page 16).

Restrain All Children

Children age 12 and under should ride properly restrained in a back seat, not the front seat. Infants and small children should be restrained in a child seat. Larger children should use a booster seat and a lap/shoulder belt until they can use the belt properly without a booster seat (see pages 40 – 60).

Be Aware of Airbag Hazards

While airbags can save lives, they can cause serious or fatal injuries to occupants who sit too close to them, or are not properly restrained. Infants, young children, and short adults are at the greatest risk. Be sure to follow all instructions and warnings in this manual.

Don't Drink and Drive

Alcohol and driving don't mix. Even one drink can reduce your ability to respond to changing conditions, and your reaction time gets worse with every additional drink. So don't drink and drive, and don't let your friends drink and drive, either.

Pay Appropriate Attention to the Task of Driving Safely

Engaging in mobile phone conversation or other activities that keep you from paying close attention to the road, other vehicles and pedestrians could lead to a crash. Remember, situations can change quickly, and only you can decide when it is safe to divert attention away from driving.

Control Your Speed

Excessive speed is a major factor in crash injuries and deaths. Generally, the higher the speed, the greater the risk, but serious injuries can also occur at lower speeds. Never drive faster than is safe for current conditions, regardless of the maximum speed posted.

Keep Your Vehicle in Safe Condition

Having a tire blowout or a mechanical failure can be extremely hazardous. To reduce the possibility of such problems, check your tire pressures and condition frequently, and perform all regularly scheduled maintenance (see page 507).

Your Vehicle's Safety Features

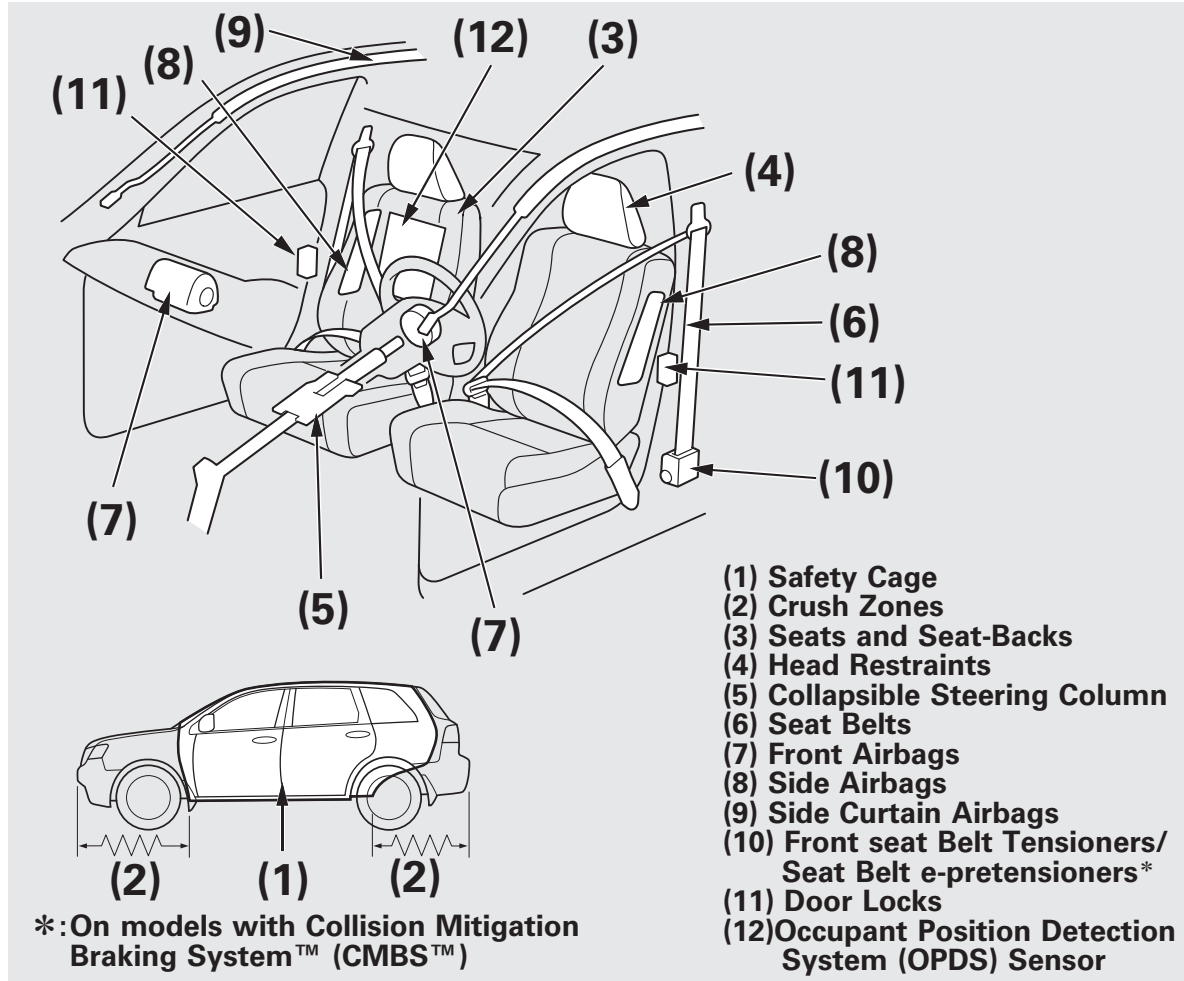

Your vehicle is equipped with many features that work together to protect you and your passengers during a crash.

Some features do not require any action on your part. These include a strong steel framework that forms a safety cage around the passenger compartment, front and rear crush zones, a collapsible steering column, and tensioners that tighten the front seat belts in a crash.

However, you and your passengers can't take full advantage of these features unless you remain sitting in the correct position and ***always wear your seat belts***. In fact, some safety features can contribute to injuries if they are not used properly.

The following pages explain how you can take an active role in protecting yourself and your passengers.

Seat Belts

Your vehicle is equipped with seat belts in all seating positions.

Your seat belt system also includes an indicator on the instrument panel and a beeper to remind you and your passengers to fasten your seat belts.

Why Wear Seat Belts

Seat belts are the single most effective safety device for adults and larger children. (Infants and smaller children must be properly restrained in child seats.)

Not wearing a seat belt properly increases the chance of serious injury or death in a crash, even though your vehicle has airbags.

In addition, most states and all Canadian provinces and territories require you to wear seat belts.

⚠ WARNING

Not wearing a seat belt properly increases the chance of serious injury or death in a crash, even though your vehicle has airbags.

Be sure you and your passengers always wear seat belts and wear them properly.

When properly worn, seat belts:

- Keep you connected to the vehicle so you can take advantage of the vehicle's built-in safety features.
- Help protect you in almost every type of crash, including:
 - frontal impacts
 - side impacts
 - rear impacts
 - rollovers

- Help keep you from being thrown against the inside of the vehicle and against other occupants.
- Keep you from being thrown out of the vehicle.
- Help keep you in a good position should the airbags ever deploy. A good position reduces the risk of injury from an inflating airbag and allows you to get the best advantage from the airbag.

Of course, seat belts cannot completely protect you in every crash. But in most cases, seat belts can reduce your risk of serious injury.

What you should do: Always wear your seat belt, and make sure you wear it properly.

Your Vehicle's Safety Features

Airbags

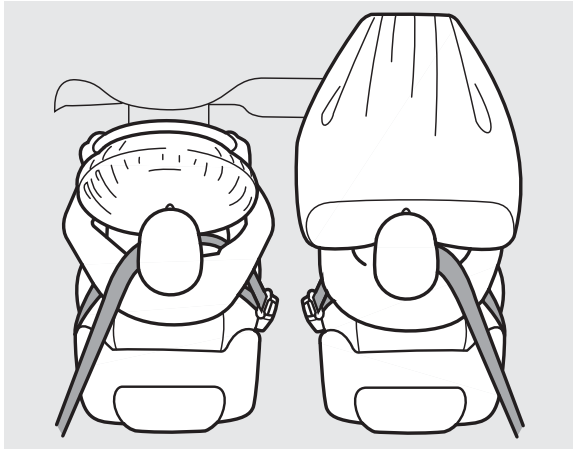

Your vehicle has a supplemental restraint system (SRS) with front airbags to help protect the heads and chests of the driver and a front seat passenger during a moderate to severe frontal collision (see page 30 for more information on how your front airbags work).

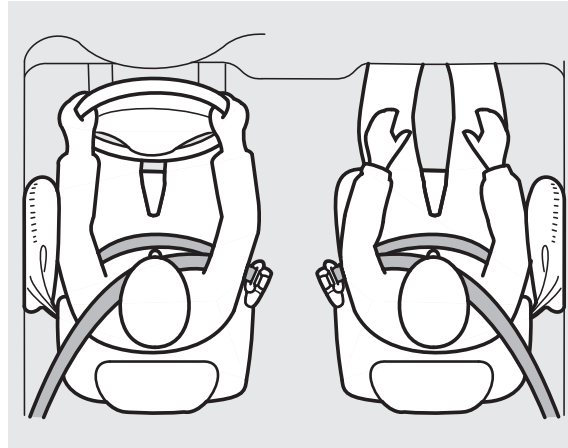

Your vehicle also has side airbags to help protect the torso and pelvis of the driver or a front seat passenger during a moderate to severe side impact (see page 33 for more information on how your side airbags work).



In addition, your vehicle has side curtain airbags to help protect the heads of the driver and passengers in outboard seating positions during a moderate-to-severe side impact. The side curtain airbags equipped in this vehicle are also designed to help reduce the likelihood of partial and complete ejection of vehicle occupants through side windows in crashes, particularly rollover crashes (see page 35 for additional information on how your side curtain airbags work).

The most important things you need to know about your airbags are:

- ***Airbags do not replace seat belts.*** They are designed to supplement the seat belts.
- ***Airbags offer no protection in rear impacts, or minor frontal or side collisions.***
- ***Airbags can pose serious hazards.*** To do their job, airbags must inflate with tremendous force. So while airbags help save lives, they can cause minor injuries or more serious or even fatal injuries if occupants are not properly restrained or sitting properly.

What you should do: Always wear your seat belt properly, and sit upright and as far back from the steering wheel as possible while allowing full control of the vehicle. A front passenger should move their seat as far back from the dashboard as possible.

The rest of this section gives more detailed information about how you can maximize your safety.

Remember, however, that no safety system can prevent all injuries or deaths that can occur in a severe crash, even when seat belts are properly worn and the airbags deploy.

Protecting Adults and Teens

Introduction

The following pages provide instructions on how to properly protect the driver, adult passengers, and teenage children who are large enough and mature enough to drive or ride in the front.

See pages 40 – 60 for important guidelines on how to properly protect infants, small children, and larger children who ride in your vehicle.

1. Close and Lock the Doors

After everyone has entered the vehicle, be sure the doors and the tailgate are closed and locked.



Your vehicle has a door/tailgate open indicator (red) on the instrument panel to indicate when any door or the tailgate is not tightly closed.

See page 140 for how to lock the doors, and page 76 for how the door/tailgate open indicator works.

Your vehicle has a door and tailgate open indicator on the multi-information display to indicate when a specific door or the tailgate is not tightly closed. You will see the appropriate indicator and the message for each condition.

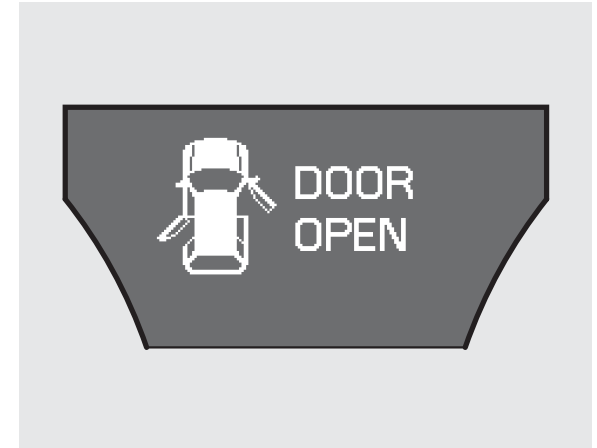

When one or more doors are not tightly closed, the “DOOR OPEN” message will come on.

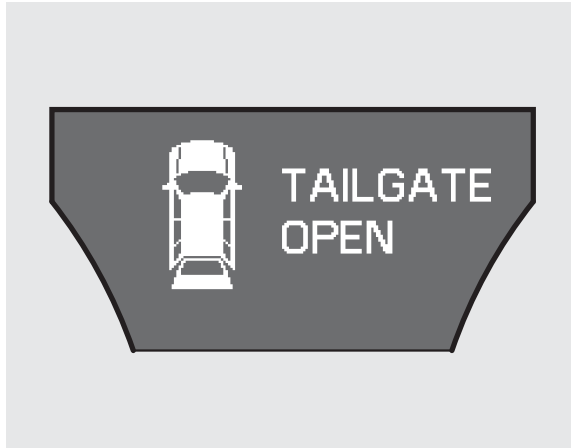

When the tailgate is not tightly closed, the “TAILGATE OPEN” message will come on.



When both tailgate and one or more doors are not tightly closed, the “DOOR & TAILGATE OPEN” message will come on.

Locking the doors reduces the chance of someone being thrown out of the vehicle during a crash, and it helps prevent passengers from accidentally opening a door and falling out.

Locking the doors also helps prevent an outsider from unexpectedly opening a door when you come to a stop.

Your vehicle has the auto door locking/unlocking feature. For more information, see page 140.

Protecting Adults and Teens

2. Adjust the Front Seats

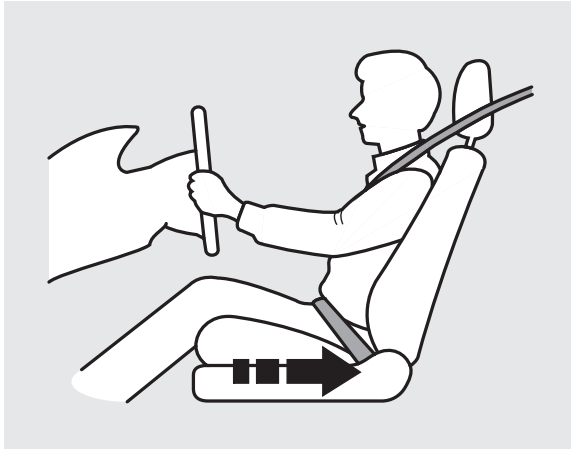

Adjust the driver's seat as far to the rear as possible while allowing you to maintain full control of the vehicle. Have a front passenger adjust their seat as far to the rear as possible.

If you sit too close to the steering wheel or dashboard, you can be seriously injured by an inflating front airbag, or by striking the steering wheel or dashboard.

The National Highway Traffic Safety Administration and Transport Canada recommend that drivers allow at least 10 inches (25 cm) between the center of the steering wheel and the chest. In addition to adjusting the seat, you can adjust the steering wheel up and down, and in and out (see page 134).

If you cannot get far enough away from the steering wheel and still reach the controls, we recommend that you investigate whether some type of adaptive equipment may help.

⚠ WARNING

Sitting too close to a front airbag can result in serious injury or death if the front airbags inflate.

Always sit as far back from the front airbags as possible.

See page 149 for how to adjust the front seats.

3. Adjust the Seat-Backs

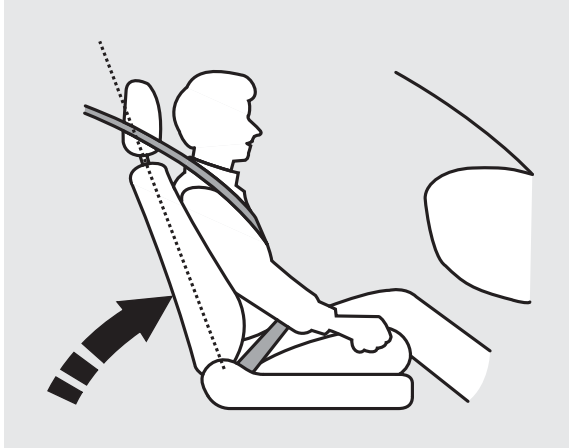

Adjust the driver's seat-back to a comfortable, upright position, leaving ample space between your chest and the airbag cover in the center of the steering wheel.

Passengers with adjustable seat-backs should also adjust their seat-back to a comfortable, upright position.

⚠ WARNING

Reclining the seat-back too far can result in serious injury or death in a crash.

Adjust the seat-back to an upright position, and sit well back in the seat.

Reclining a seat-back so that the shoulder part of the belt no longer rests against the occupant's chest reduces the protective capability of the belt. It also increases the chance of sliding under the belt in a crash and being seriously injured. The farther a seat-back is reclined, the greater the risk of injury.

See page 149 for how to adjust the seat-backs.

4. Adjust the Head Restraints

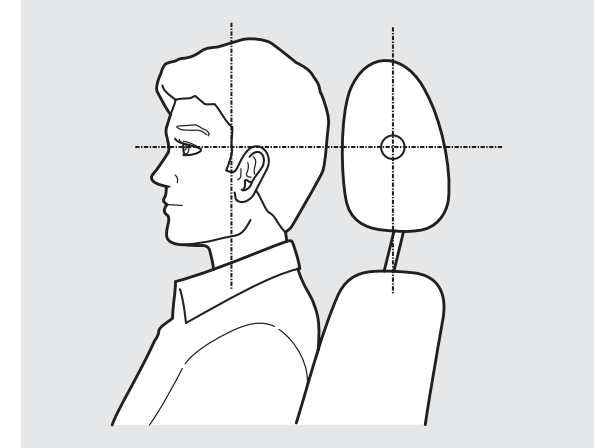

Adjust the driver's head restraint so the center of the back of your head rests against the center of the restraint.

Have passengers adjust their head restraints properly as well. Taller persons should adjust their restraint as high as possible.

CONTINUED

Protecting Adults and Teens

⚠ WARNING

Improperly positioning head restraints reduces their effectiveness and you can be seriously injured in a crash.

Make sure head restraints are in place and positioned properly before driving.

Properly adjusted head restraints will help protect occupants from whiplash and other crash injuries.

See page 150 for how to adjust the head restraints and how the driver's and front passenger's active head restraints work.

5. Fasten and Position the Seat Belts

Insert the latch plate into the buckle, then tug on the belt to make sure the belt is securely latched. Check that the belt is not twisted, because a twisted belt can cause serious injuries in a crash.

The second row center seat, and both third row seats, have a detachable shoulder belt that can be unlatched and retracted, to allow the seats to be folded down. See page 155 for how to unlatch and relatch the seat belts.



Position the lap part of the belt as low as possible across your hips, then pull up on the shoulder part of the belt so the lap part fits snugly. This lets your strong pelvic bones take the force of a crash and reduces the chance of internal injuries.

If necessary, pull up on the belt again to remove any slack, then check that the belt rests across the center of your chest and over your shoulder.

This spreads the forces of a crash over the strongest bones in your upper body.

⚠ WARNING

Improperly positioning the seat belts can cause serious injury or death in a crash.

Make sure all seat belts are properly positioned before driving.

If the seat belt touches or crosses your neck, or if it crosses your arm instead of your shoulder, you need to adjust the seat belt anchor height.

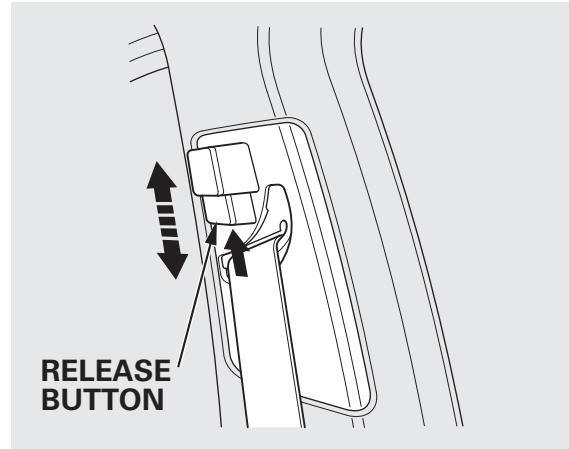

The front seats have adjustable seat belt anchors. To adjust the height of an anchor, squeeze the release button and slide the anchor up or down as needed (it has four positions).

Never place the shoulder portion of a lap/shoulder belt under your arm or behind your back. This could cause very serious injuries in a crash.

If a seat belt does not seem to work properly, it may not protect the occupant in a crash.

No one should sit in a seat with an inoperative seat belt. Using a seat belt that is not working properly can result in serious injury or death. Have your dealer check the belt as soon as possible.

See page 21 for additional information about your seat belts and how to take care of them.

Protecting Adults and Teens

6. Maintain a Proper Sitting Position

After all occupants have adjusted their seats and head restraints, and put on their seat belts, it is very important that they continue to sit upright, well back in their seats, with their feet on the floor, until the vehicle is safely parked and the engine is off.

Sitting improperly can increase the chance of injury during a crash. For example, if an occupant slouches, lies down, turns sideways, sits forward, leans forward or sideways, or puts one or both feet up, the chance of injury during a crash is greatly increased.

In addition, an occupant who is out of position in the front seat can be seriously or fatally injured in a crash by striking interior parts of the vehicle or being struck by an inflating front airbag.

WARNING

Sitting improperly or out of position can result in serious injury or death in a crash.

Always sit upright, well back in the seat, with your feet on the floor.

Advice for Pregnant Women



If you are pregnant, the best way to protect yourself and your unborn child when driving or riding in a vehicle is to always wear a seat belt, and keep the lap part of the belt as low as possible across the hips.

When driving, remember to sit upright and adjust the seat as far back as possible while allowing full control of the vehicle. When riding as a front passenger, adjust the seat as far back as possible.

This will reduce the risk of injuries to both you and your unborn child that can be caused by a crash or an inflating front airbag.

Each time you have a checkup, ask your doctor if it's okay for you to drive.

Protecting Adults and Teens

Additional Safety Precautions

- ***Never let passengers ride in the cargo area or on top of a folded-down back seat.*** If they do, they could be very seriously injured in a crash.
- ***Passengers should not stand up or change seats while the vehicle is moving.*** A passenger who is not wearing a seat belt during a crash or emergency stop can be thrown against the inside of the vehicle, against other occupants, or out of the vehicle.
- ***Two people should never use the same seat belt.*** If they do, they could be very seriously injured in a crash.
- ***Do not put any accessories on seat belts.*** Devices intended to improve occupant comfort or reposition the shoulder part of a seat belt can reduce the protective capability of the belt and increase the chance of serious injury in a crash.
- ***Do not place hard or sharp objects between yourself and a front airbag.*** Carrying hard or sharp objects on your lap, or driving with a pipe or other sharp object in your mouth, can result in injuries if your front airbag inflates.
- ***Keep your hands and arms away from the airbag covers.*** If your hands or arms are close to an airbag cover, they could be injured if the airbag inflates.
- ***Do not attach or place objects on the front airbag covers.*** Objects on the covers marked “SRS AIRBAG” could interfere with the proper operation of the airbags or be propelled inside the vehicle and hurt someone if the airbags inflate.
- ***Do not attach hard objects on or near a door.*** If a side airbag or a side curtain airbag inflates, a cup holder or other hard object attached on or near the door could be propelled inside the vehicle and hurt someone.
- ***Do not cover or replace front seat-back covers without consulting your dealer.*** Improperly replacing or covering front seat-back covers can prevent your side airbags from inflating during a side impact.

Additional Information About Your Seat Belts

Seat Belt System Components

Your seat belt system includes lap/shoulder belts in all seating positions. The front seat belts are also equipped with automatic seat belt tensioners and, on models with collision mitigation braking system™ (CMBS™), seat belt e-pretensioners.



The seat belt system includes an indicator on the instrument panel and a beeper to remind you and your front passenger to fasten your seat belts.

This system monitors the front seat belts. If you turn the ignition switch to the ON (II) position before your seat belt is fastened, the beeper will sound and the indicator will flash. If your seat belt is not fastened before the beeper stops, the indicator will stop flashing but remain on.

If a front passenger does not fasten their seat belt, the indicator will come on about 6 seconds after the ignition switch is turned to the ON (II) position.

If either the driver or a front passenger does not fasten their seat belt while driving, the beeper will sound and the indicator will flash again at regular intervals.

You will also see a “FASTEN SEAT BELT” or “FASTEN PASSENGER SEAT BELT” message on the multi-information display (see page 87).

When no one is sitting in the front passenger's seat, the indicator should not come on and the beeper should not sound. When an infant or small child is riding there, the indicator may not come on and the beeper may not sound.

CONTINUED

Additional Information About Your Seat Belts

If the indicator comes on or the beeper sounds when the driver's seat belt is latched and there is no front seat passenger and no items on the front seat, something may be interfering with the monitoring system. Look for and remove:

- Any items under the front passenger's seat.
- Any object(s) hanging on the seat or in the seat-back pocket.
- Any object(s) touching the rear of the seat-back.

If no obstructions are found, have your vehicle checked by a dealer.

Lap/Shoulder Belt

The lap/shoulder belt goes over your shoulder, across your chest, and across your hips.

To fasten the belt, insert the latch plate into the buckle, then tug on the belt to make sure the buckle is latched (see page 16 for how to properly position the belt).

To unlock the belt, press the red PRESS button on the buckle. Guide the belt across your body so that it retracts completely. After exiting the vehicle, be sure the belt is out of the way and will not get closed in the door.

All seat belts have an emergency locking retractor. In normal driving, the retractor lets you move freely in your seat while it keeps some tension on the belt. During a collision or sudden stop, the retractor automatically locks the belt to help restrain your body.

The seat belts in all positions except the driver's have a lockable retractor that must be activated to secure a child seat (see page 53).

If the shoulder part of the belt is pulled all the way out, the lockable retractor will activate. The belt will retract, but it will not allow the passenger to move freely.

To deactivate the lockable retractor, unlatch the buckle and let the seat belt fully retract. To refasten the seat belt, pull it out only as far as needed.

Additional Information About Your Seat Belts

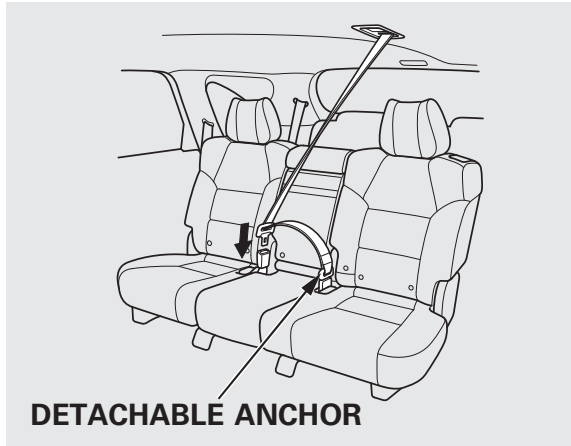

The lap/shoulder belts in the center seat of the second row and both of the third row seats are equipped with a detachable anchor that has two parts: a small latch plate and a buckle.

The detachable seat belt should normally be latched whenever the seat-backs are in an upright position. For more information about the detachable seat belt, see page 155.

⚠ WARNING

Allowing a child to play with a seat belt or wrap one around their neck can result in serious injury or death.

Instruct children not to play with any seat belt and make sure any unused seat belt a child can reach is buckled, fully retracted, and locked.

Automatic Seat Belt Tensioners

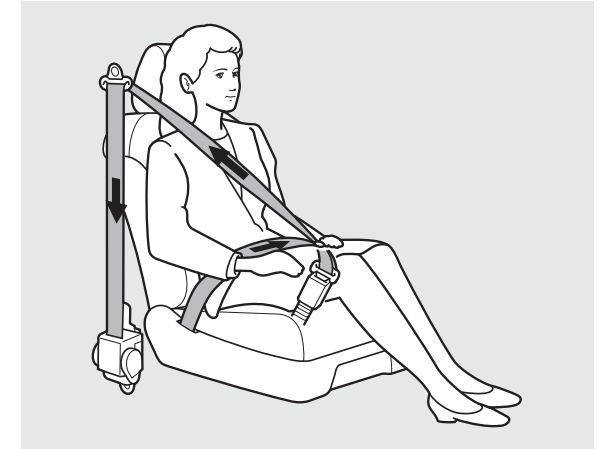

For added protection, the front seat belts are equipped with automatic seat belt tensioners. When activated, the tensioners immediately tighten the belts to help hold the driver and a front passenger in position.

Additional Information About Your Seat Belts

The tensioners can be activated during a collision in which the front airbags *do not deploy*. In this case, the airbags would not be needed, but the extra tension in the seat belt could be helpful.

If the tensioner is activated, the SRS indicator comes on and the tensioner must be replaced.

Seat Belt e-pretensioners

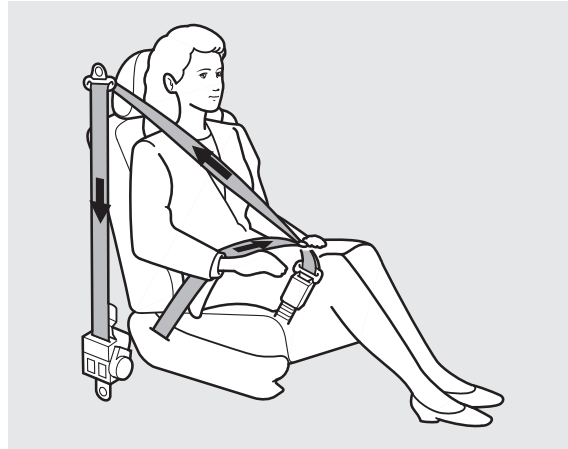

On models with Collision Mitigation Braking System™ (CMBS™)

For added safety, the front seat belts are equipped with e-pretensioners that work in combination with the collision mitigation braking system™ (CMBS™) (see page 463) and the brake pedal assist function (see page 460).

If your vehicle gets too close to the vehicle ahead of it in your lane, the driver's e-pretensioner slightly retracts the seat belt to alert the driver of the approaching vehicle. If a collision with the vehicle in front of you is likely, the e-pretensioners on both front seats retract the seat belts with enough force to properly restrain you and your front passenger. After they activate, the e-pretensioners release the retracted seat belts.

To get the full benefit of the e-pretensioners, you and your front passenger must sit normally in your seats and wear your seat belts properly (see page 16).

Additional Information About Your Seat Belts

If the automatic seat belt tensioners are activated by a collision, both front seat belts and all related components must be replaced (see page 25). If only the e-pretensioners were activated, no components need to be replaced.

In addition, the front passenger's e-pretensioner does not activate when the passenger's airbag is automatically turned off because the weight sensor detects a child in the front passenger's seat.

Seat Belt Maintenance

For safety, you should check the condition of your seat belts regularly.

Pull each belt out fully, and look for frays, cuts, burns, and wear. Check that the latches work smoothly and the belts retract easily. If a belt does not retract easily, cleaning the belt may correct the problem (see page 534). Any belt that is not in good condition or working properly will not provide good protection and should be replaced as soon as possible.

Acura provides a limited warranty on seat belts. See your *Acura Warranty Information* booklet for details.

If a seat belt is worn during a crash, you should have your dealer inspect the belt, and replace it if necessary. A belt that has been worn during a crash may not provide the same level of protection in a subsequent crash.

The dealer should also inspect the anchors for damage and replace them if needed. If the automatic seat belt tensioners activate during a crash, they must be replaced.

CONTINUED

Additional Information About Your Seat Belts

⚠ WARNING

Not checking or maintaining seat belts can result in serious injury or death if the seat belts do not work properly when needed.

Check your seat belts regularly and have any problem corrected as soon as possible.

Additional Information About Your Airbags

Airbag System Components

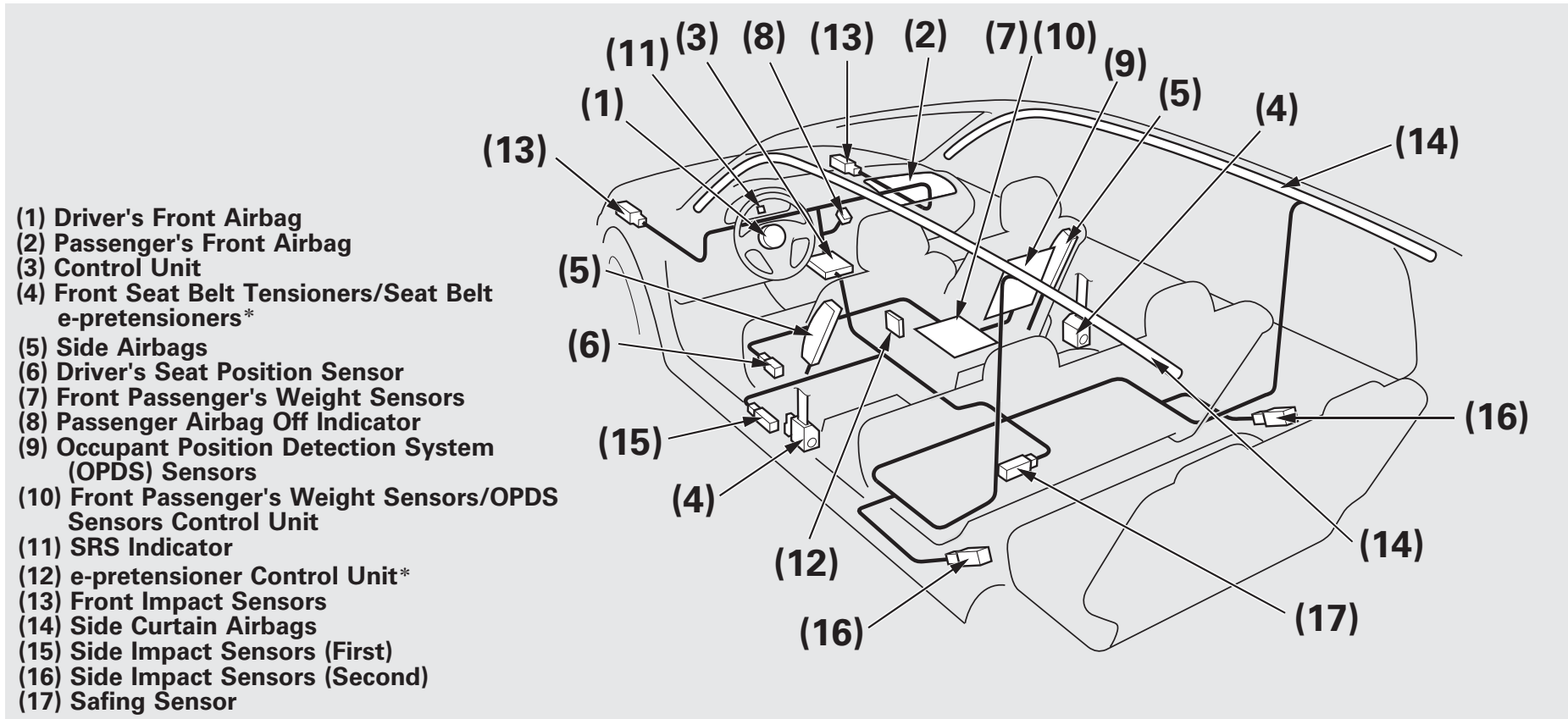

Driver and Passenger Safety

*: On models with CMBS

CONTINUED

Additional Information About Your Airbags

Your Airbag System (SRS) includes:

- Two SRS (Supplemental Restraint System) front airbags. The driver's airbag is stored in the center of the steering wheel; the front passenger's airbag is stored in the dashboard. Both are marked "SRS AIRBAG" (see page 30).
- Two side airbags, one for the driver and one for a front passenger. The airbags are stored in the outer edges of the seat-backs. Both are marked "SIDE AIRBAG" (see page 33).
- Two side curtain airbags, one for each side of the vehicle. The airbags are stored in the ceiling above the side windows. The front and rear pillars are marked "SIDE CURTAIN AIRBAG" (see page 35).
- On models with CMBS, front seat belt e-pretensioners (see page 24).
- Automatic front seat belt tensioners (see page 23).
- Sensors that can detect a moderate to severe front impact, side impact, or if your vehicle is about to rollover.
- Sensors that can detect whether a child is in the passenger's side airbag path and signal the control unit to turn the airbag off (see page 34).
- Sensors that can detect whether the driver's seat belt and the front passenger's seat belt are latched or unlatched (see page 21).
- A driver's seat position sensor that monitors the distance of the seat from the front airbag. If the seat is too far forward, the airbag will inflate with less force (see page 31).

Additional Information About Your Airbags

- Weight sensors that monitor the weight on the front passenger's seat. If the weight is about 65 lbs (29 kg) or less (the weight of an infant or small child), the passenger's front airbag will be turned off (see page 31).
- A rollover sensor that can detect if your vehicle is about to roll over and signal the control unit to deploy both side curtain airbags (see page 35).
- A sophisticated electronic system that continually monitors and records information about the sensors, the control unit, the airbag activators, the seat belt tensioners, and driver and front passenger seat belt use when the ignition switch is in the ON (II) position.
- An indicator on the instrument panel that alerts you to a possible problem with your airbag system components (see page 36 and 67).
- An indicator on the instrument panel that alerts you that the passenger's side airbag has been turned off (see page 36).
- An indicator on the dashboard that alerts you that the passenger's front airbag has been turned off (see page 37).
- Emergency backup power in case your vehicle's electrical system is disconnected in a crash.

Additional Information About Your Airbags

How Your Front Airbags Work

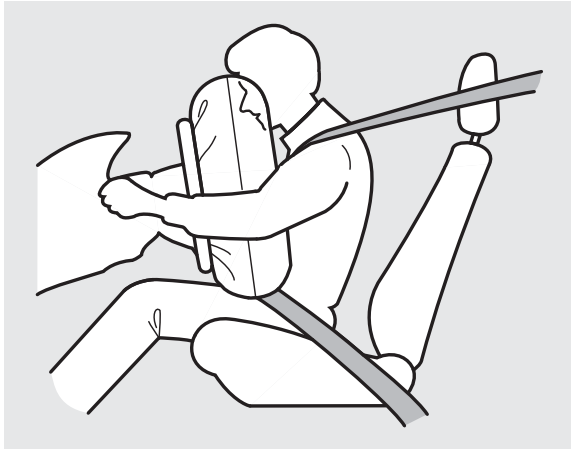

If you ever have a moderate to severe frontal collision, sensors will detect the vehicle's rapid deceleration.

If the rate of deceleration is high enough, the control unit will inflate the driver's and front passenger's airbags, at the time and with the force needed.

During a frontal crash, your seat belt restrains your lower body and torso, and the front airbag helps protect your head and chest.

Although both airbags normally inflate within a split second of each other, it is possible for only one airbag to deploy.

This can happen if the severity of a collision is at the margin, or threshold, that determines whether or not the airbags will deploy. In such cases, the seat belt will provide sufficient protection, and the supplemental protection offered by the airbag would be minimal.

Only the driver's airbag will deploy if there is no passenger in the front seat, or if the advanced airbag system has turned the passenger's airbag off (see page 37).

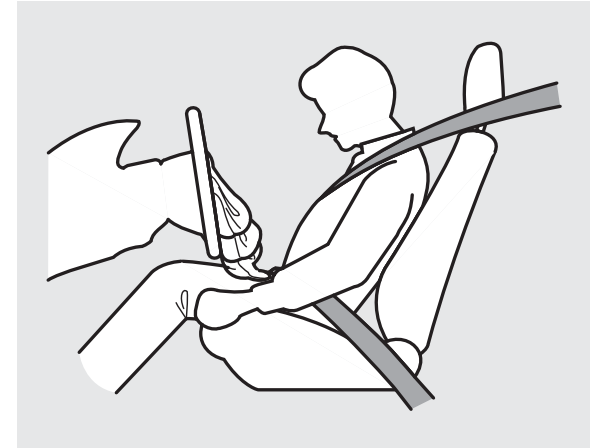

After inflating, the front airbags immediately deflate, so they won't interfere with the driver's visibility, or the ability to steer or operate other controls.

Additional Information About Your Airbags

The total time for inflation and deflation is less than of a second, so fast that most occupants are not aware that the airbags deployed until they see them lying in their laps.

After a crash, you may see what looks like smoke. This is actually powder from the airbag's surface. Although the powder is not harmful, people with respiratory problems may experience some temporary discomfort. If this occurs, get out of the vehicle as soon as it is safe to do so.

Dual-Stage, Multiple-Threshold Front Airbags (SRS)

Your vehicle is equipped with dual-stage, multiple-threshold front airbags (SRS). During a frontal crash severe enough to cause one or both front airbags to deploy, the airbags can inflate at different rates, depending on the severity of the crash, whether or not the seat belts are latched, and/or other factors. Front airbags are designed to supplement the seat belts to help reduce the likelihood of head and chest injuries in frontal crashes.

Advanced Airbags

Your front airbags are also advanced airbags. The main purpose of this feature is to help prevent airbag-caused injuries to short drivers and children or small statured adults who ride in front.

For both advanced airbags to work properly:

- Occupants must sit upright and wear their seat belts properly.
- Do not spill any liquids on or under the seats, cover the sensors, or put any objects or metal items under the front seats.
- Objects placed or pushed under the front passenger's seat may cause the sensor to malfunction, increasing the risk of injury in a crash.

Failure to follow these instructions could damage the sensors or prevent them from working properly.

CONTINUED

Additional Information About Your Airbags

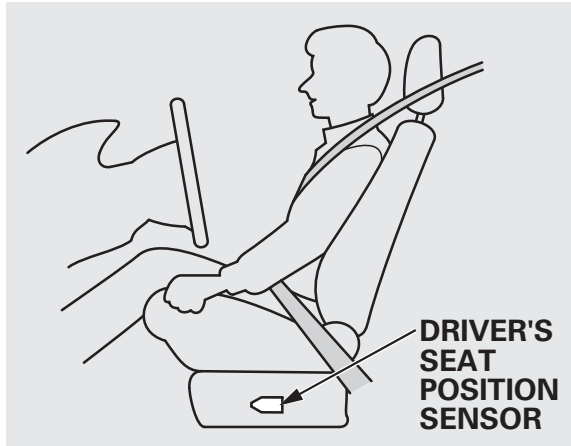

The driver's advanced front airbag system includes a seat position sensor under the seat. If the seat is too far forward, the airbag will inflate with less force, regardless of the severity of the impact.

If there is a problem with the sensor, the SRS indicator will come on, and the airbag will inflate in the normal manner regardless of the driver's seating position.

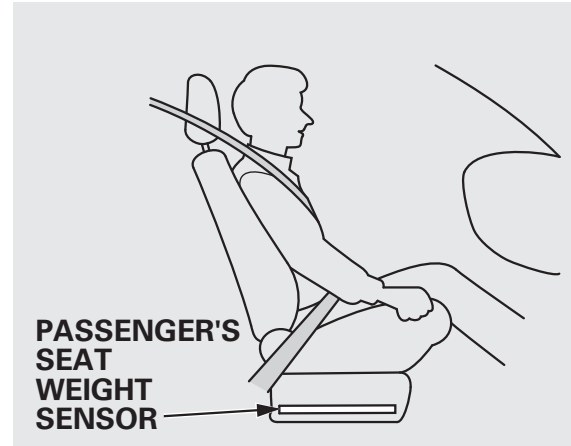

The passenger's advanced front airbag system has weight sensors under the seat. Although Acura does not encourage carrying an infant or small child in front, if the sensors detect the weight of an infant or small child (up to about 65 lbs or 29 kg), the system will automatically turn the passenger's front airbag off.

Be aware that objects placed on the passenger's seat can also cause the airbag to be turned off.

When the passenger airbag gets turned off by the weight sensors, a "passenger airbag off" indicator in the center of the dashboard comes on (see page 37).

If the weight sensors detect there is no passenger in the front seat, the airbag is automatically turned off. However, the passenger airbag off indicator in this situation will not come on.

Additional Information About Your Airbags

To ensure that the passenger's advanced front airbag system will work properly, ***do not do anything that would increase or decrease the weight on the front passenger's seat.*** This includes:

- A second-row passenger pushing or pulling on the back of the front passenger's seat.
- Moving the front seat forcibly back against cargo on the seat or floor behind it.
- Hanging heavy items on the front passenger seat, or placing heavy items in the seat-back pocket.
- Moving the front passenger's seat or seat-back forcibly back against the folded right-side second-row seat.
- Second-row seat passenger should not wedge objects or intentionally force their feet under the front passenger seat.

Also, make sure the floor mat behind the front passenger's seat is hooked to the floor mat anchor (see page 535). If it is not, the mat may interfere with the proper operation of the sensors and operation of the seat.

How Your Side Airbags Work

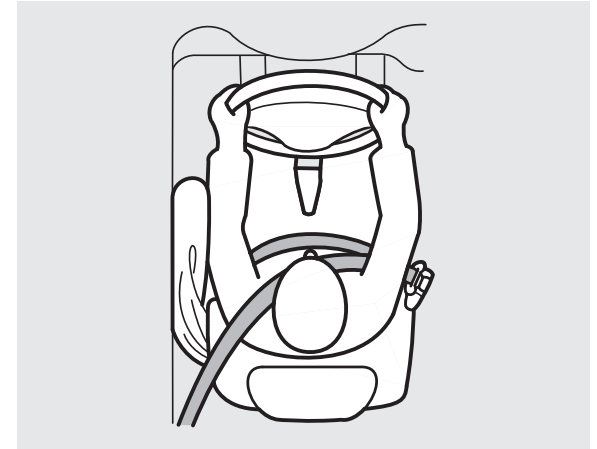

If you ever have a moderate to severe side impact, sensors will detect rapid acceleration and signal the control unit to instantly inflate either the driver's or the passenger's side airbag and activate the seat belt tensioner on the affected side.

CONTINUED

Additional Information About Your Airbags

Only one airbag will deploy during a side impact. If the impact is on the passenger's side, the passenger's side airbag may not deploy if there is no passenger.

To get the best protection from the side airbags, front seat occupants should wear their seat belts and sit upright and well back in their seats.

Side Airbag Cutoff System

Your vehicle has a side airbag cutoff system designed primarily to protect a child riding in the front passenger's seat.

Although Acura does not encourage children to ride in front, if the position sensors detect a child has leaned into the side airbag's deployment path, the airbag will shut off.

The side airbag may also shut off if a short adult leans sideways, or a larger adult slouches and leans sideways into the airbag's deployment path.

Objects placed on the front passenger seat can also cause the side airbag to be shut off.

If the side airbag off indicator comes on (see page 36), have the passenger sit upright. Once the passenger is out of the airbag's deployment path, the system will turn the airbag back on, and the indicator will go out.

There will be some delay between the moment the passenger moves into or out of the airbag deployment path and when the indicator comes on or goes off.

A front seat passenger should not use a cushion or another object as a backrest. It may prevent the cutoff system from working properly.

Additional Information About Your Airbags

How Your Side Curtain Airbags Work

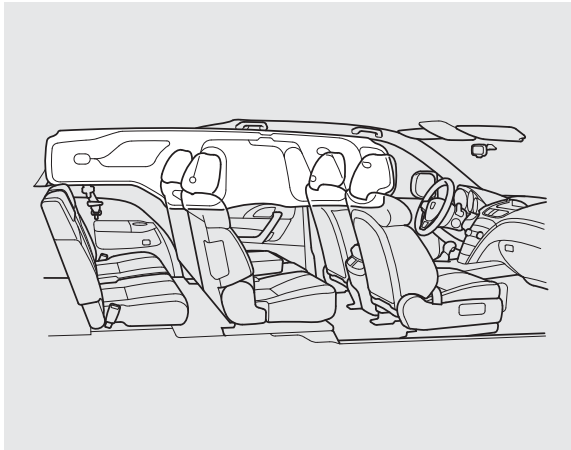

In a Side Impact

In a moderate to severe side impact, sensors will detect rapid acceleration and signal the control unit to instantly inflate the side curtain airbag and activate the seat belt tensioner on the impacted side of the vehicle.

If the impact is on the passenger's side, the passenger's side curtain airbag will inflate even if there are no occupants on that side of the vehicle.

In a Rollover

If the rollover sensor detects your vehicle is about to roll over, it signals the control unit, which immediately deploys both side curtain airbags and activates both front seat belt tensioners.

The airbag on the passenger's side will deploy even if there are no passengers on that side of the vehicle.

To get the best protection from the side curtain airbags, occupants should wear their seat belts and sit upright and well back in their seats.

Additional Information About Your Airbags

How the SRS Indicator Works



The SRS indicator alerts you to a potential problem with your airbag system components.

When you turn the ignition switch to the ON (II) position, this indicator comes on briefly then goes off. This tells you the system is working properly.

If the indicator comes on at any other time, or does not come on at all, you should have the system checked by your dealer. For example:

- If the SRS indicator does not come on after you turn the ignition switch to the ON (II) position.
- If the indicator stays on after the engine starts.
- If the indicator comes on or flashes on and off while you drive.

You will also see a “CHECK AIRBAG SYSTEM” message on the multi-information display (see page 87).

If you see any of these indications, the airbag system components may not work properly when you need them.

WARNING

Ignoring the SRS indicator can result in serious injury or death if the airbag systems or tensioners do not work properly.

Have your vehicle checked by a dealer as soon as possible if the SRS indicator alerts you to a possible problem.

How the Side Airbag Off Indicator Works

U.S.

Canada



This indicator alerts you that the passenger's side airbag has been automatically shut off. It does *not* mean there is a problem with your side airbags.

When you turn the ignition switch to the ON (II) position, the indicator should come on briefly and then go out (see page 70). If it does not come on, stays on, or comes on while driving without a passenger in the front seat, you will also see a “PASSENGER SIDE AIRBAG OFF” message on the multi-information display. Have the system checked (see page 87).

How the Passenger Airbag Off Indicator Works

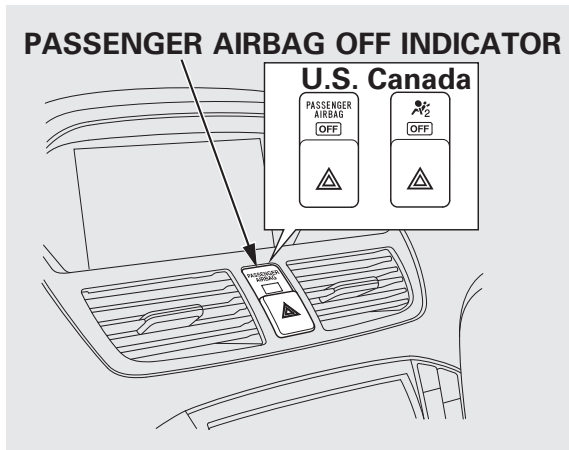

This indicator alerts you that the passenger's front airbag has been shut off because weight sensors detect about 65 lbs (29 kg) or less (the weight of an infant or small child) on the front passenger's seat. It does **not mean** there is a problem with the airbag.

Be aware that objects placed on the front seat can cause the indicator to come on.

If no weight is detected on the front seat, the airbag will be automatically shut off. However, the indicator will not come on.

The passenger airbag off indicator may come on and off repeatedly if the total weight on the seat is near the airbag cutoff threshold.

If an adult or teenage passenger is riding in front, move the seat as far to the rear as possible, and have the passenger sit upright and wear the seat belt properly.

If the indicator comes on with no front seat passenger and no objects on the seat, or with an adult riding there, something may be interfering with the weight sensors. Look for and remove:

- Any items under the front passenger's seat.
- Any object(s) hanging on the seat or in the seat-back pocket.
- Any object(s), such as a folded-down back seat, that are touching the rear of the seat-back.

If no obstructions are found, have your vehicle checked by a dealer as soon as possible.

Additional Information About Your Airbags

Airbag Service

Your airbag systems are virtually maintenance free, and there are no parts you can safely service.

However, you must have your vehicle serviced if:

- ***An airbag ever inflates.*** Any airbag that has deployed must be replaced along with the control unit and other related parts. Any seat belt tensioner that activates must also be replaced.

We recommend against the use of salvaged airbag system components, including the airbag, tensioners, sensors, and control unit.

Do not try to remove or replace any airbag by yourself. This must be done by an authorized dealer or a knowledgeable body shop.

- ***The SRS indicator alerts you to a problem.*** Take your vehicle to an authorized dealer as soon as possible. If you ignore this indication, your airbags may not operate properly.

- ***If your vehicle has a moderate to severe impact.*** Even if your airbags do not inflate, your dealer should inspect the driver's seat position sensor, the front passenger's weight sensors, the front seat belt tensioners, and all seat belts and their anchors worn during a crash to make sure they are operating properly.

Additional Information About Your Airbags

Additional Safety Precautions

- ***Do not attempt to deactivate your airbags.*** Together, airbags and seat belts provide the best protection.
 - ***Do not tamper with airbag components or wiring for any reason.*** Tampering could cause the airbags to deploy, possibly causing very serious injury.
- ***Do not expose the front passenger's seat-back to liquid.*** If water or another liquid soaks into a seat-back, it can prevent the side airbag cutoff system from working properly.
- ***Do not remove or modify a front seat without consulting your dealer.*** This could make the driver's seat position sensor or the front passenger's weight sensors ineffective. If it is necessary to remove or modify a front seat to accommodate a person with disabilities, first contact Acura Client Relations. In the US call 800-382-2238 and in Canada call 888-9-ACURA-9.

Protecting Children – General Guidelines

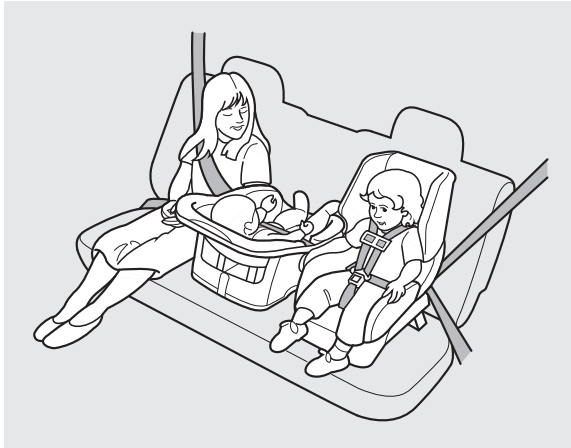

Children depend on adults to protect them. However, despite their best intentions, many adults do not know how to *properly* protect child passengers.

If you have children, or ever need to drive with a child in your vehicle, be sure to read this section. It begins with important general guidelines, then presents special information for infants, small children, and larger children.

All Children Must Be Restrained

Each year, many children are injured or killed in vehicle crashes because they are either unrestrained or not properly restrained. In fact, traffic collisions are the number one cause of the death of children age 12 and under.

To reduce the number of child deaths and injuries, every state, Canadian province and territory requires that infants and children be properly restrained when they ride in a vehicle.

Infants and small children must be restrained in an approved child seat that is properly secured to the vehicle (see pages 45 – 56).

⚠ WARNING

Children who are unrestrained or improperly restrained can be seriously injured or killed in a crash.

Any child too small for a seat belt should be properly restrained in a child seat. A larger child should be properly restrained with a seat belt and use a booster seat if necessary.

Larger children must be restrained with a lap/shoulder belt and ride on a booster seat until the seat belt fits them properly (see pages 57 – 60).

All Children Should Sit in a Back Seat

According to crash statistics, children of all ages and sizes are safer when they are restrained in a back seat.

The National Highway Traffic Safety Administration and Transport Canada recommend that all children aged 12 and under be properly restrained in a back seat. Some states have laws restricting where children may ride.

Children who ride in the back are less likely to be injured by striking interior vehicle parts during a collision or hard braking. Also, children cannot be injured by an inflating front airbag when they ride in the back.

The Passenger's Front Airbag Can Pose Serious Risks

Front airbags have been designed to help protect adults in a moderate to severe frontal collision. To do this, the passenger's front airbag is quite large, and it can inflate with enough force to cause very serious injuries.

Even though your vehicle has an advanced front airbag system that automatically turns the passenger's front airbag off under certain circumstances (see page 37), please follow these guidelines:

Infants

Never put a rear-facing child seat in the front seat of a vehicle equipped with a passenger's front airbag. If the airbag inflates, it can hit the back of the child seat with enough force to kill or very seriously injure an infant.

Small Children

Placing a forward-facing child seat in the front seat of a vehicle equipped with a passenger's front airbag can be hazardous. If the vehicle seat is too far forward, or the child's head is thrown forward during a collision, an inflating front airbag can strike the child with enough force to kill or very seriously injure a small child.

Larger Children

Children who have outgrown child seats are also at risk of being injured or killed by an inflating passenger's front airbag. Whenever possible, larger children should sit in the back seat, on a booster seat if needed, and be properly restrained with a seat belt. (See page 57 for important information about protecting larger children.)

CONTINUED

Protecting Children – General Guidelines

To remind you of the passenger's front airbag hazards, and that children must be properly restrained in a back seat, your vehicle has warning labels on the dashboard (U.S. models) and on the front visors. Please read and follow the instructions on these labels.

U.S. Models

SUN VISORS



Canadian Models

SUN VISORS

<p>CAUTION TO AVOID SERIOUS INJURY:</p> <ul style="list-style-type: none">• FOR MAXIMUM SAFETY PROTECTION IN ALL TYPES OF CRASHES, YOU MUST ALWAYS WEAR YOUR SAFETY BELT.• DO NOT INSTALL REARWARD-FACING CHILD SEATS IN ANY FRONT PASSENGER SEAT POSITION.• DO NOT SIT OR LEAN UNNECESSARILY CLOSE TO THE AIR BAG.• DO NOT PLACE ANY OBJECTS OVER THE AIR BAG OR BETWEEN THE AIR BAG AND YOURSELF.• SEE THE OWNER'S MANUAL FOR FURTHER INFORMATION AND EXPLANATIONS.	<p>PRECAUTIONS: POUR EVITER DES BLESSURES GRAVES:</p> <ul style="list-style-type: none">• POUR PROFITER D'UNE PROTECTION MAXIMALE LORS D'UNE COLLISION BOUCLEZ TOUJOURS VOTRE CEINTURE DE SECURITE.• N'INSTALLEZ JAMAIS UN SIEGE POUR ENFANTS FAISANT FACE A L'ARRIERE SUR LE SIEGE DU PASSAGER AVANT.• NE VOUS APPUYEZ PAS ET NE VOUS ASSOYEZ PAS PRES DU COUSSIN GONFLABLE.• NE DEPOSEZ AUCUN OBJET SUR LE COUSSIN GONFLABLE OU ENTRE LE COUSSIN GONFLABLE ET VOUS.• LISEZ LE GUIDE UTILISATEUR POUR DE PLUS AMPLES RENSEIGNEMENTS.
--	--

DASHBOARD

This Vehicle is Equipped with Advanced Air Bags

Even with Advanced Air Bags

Children can be killed or seriously injured by the air bag.
The back seat is the safest place for children.
Never put a rear-facing child seat in the front.
Always use seat belts and child restraints.
See owner's manual for more information about air bags.

To be removed by owner only.

If You Must Drive with Several Children

Your vehicle has two rows of back seats where children can be properly restrained. If you ever have to carry a group of children, and a child must ride in front:

- Place the largest child in the front seat, provided the child is large enough to wear the lap/shoulder belt properly (see page 57).
- Move the vehicle seat as far to the rear as possible (see page 149).
- Have the child sit upright and well back in the seat (see page 18).
- Make sure the seat belt is properly positioned and secured (see page 16).

If a Child Requires Close Attention

Many parents say they prefer to put an infant or a small child in the front passenger seat so they can watch the child, or because the child requires attention.

Placing a child in the front seat exposes the child to hazards in a frontal collision, and paying close attention to a child distracts the driver from the important tasks of driving, placing both of you at risk.

If a child requires close physical attention or frequent visual contact, we strongly recommend that another adult ride with the child in a back seat. The back seat is far safer for a child than the front.

Protecting Children – General Guidelines

Additional Safety Precautions

- **Never hold an infant or child on your lap.** If you are not wearing a seat belt in a crash, you could be thrown forward and crush the child against the dashboard or a seat-back. If you are wearing a seat belt, the child can be torn from your arms and be seriously hurt or killed.
 - **Never put a seat belt over yourself and a child.** During a crash, the belt could press deep into the child and cause serious or fatal injuries.
 - **Use the childproof door locks to prevent children from opening the rear doors.** This can prevent children from accidentally falling out (see page 141).
 - **Make sure any unused seat belt that a child can reach is buckled, the lockable retractor is activated, and the belt is fully retracted and locked.** If a child wraps a loose seat belt around their neck, they can be seriously or fatally injured. (See pages 53 and 54 for how to activate and deactivate the lockable retractor.)
 - **Never let two children use the same seat belt.** If they do, they could be very seriously injured in a crash.
 - **Do not leave children alone in a vehicle.** Leaving children without adult supervision is illegal in most states, Canadian provinces/territories, and can be very hazardous.
- For example, infants and small children left in a vehicle on a hot day can die from heatstroke. A child left alone with the key in the ignition switch can accidentally set the vehicle in motion, possibly injuring themselves or others.
- **Lock all doors and the tailgate when your vehicle is not in use.** Children who play in vehicles can accidentally get trapped inside. Teach your children not to play in or around vehicles.
 - **Keep vehicle keys/remote transmitters out of the reach of children.** Even very young children learn how to unlock vehicle doors, turn on the ignition switch, and open the tailgate, which can lead to accidental injury or death.

Protecting Infants

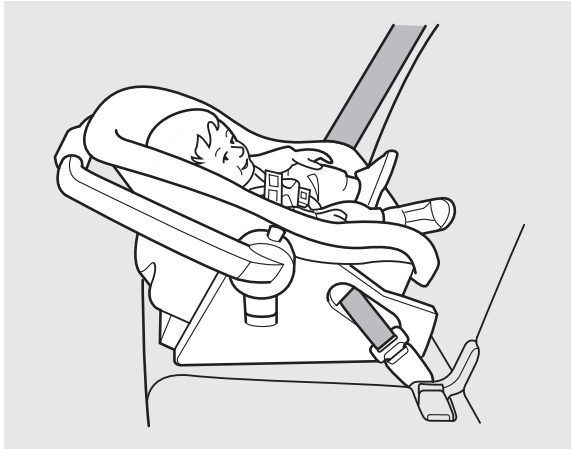

Child Seat Type

An infant must be properly restrained in a rear-facing, reclining child seat until the child reaches the seat maker's weight or height limit for the seat, and the child is at least one year old.

Only a rear-facing child seat provides proper support for a baby's head, neck, and back.

Two types of seats may be used: a seat designed exclusively for infants, or a convertible seat used in the rear-facing, reclining mode.

Do not put a rear-facing child seat in a forward-facing position. If placed facing forward, an infant could be very seriously injured during a frontal collision.

Rear-facing Child Seat Placement

A rear-facing child seat can be placed in any seating position in the back seat, but not in the front. ***Never put a rear-facing child seat in the front seat.***

If the passenger's front airbag inflates, it can hit the back of the child seat with enough force to kill or seriously injure an infant.

When properly installed in the second row, a rear-facing child seat may prevent the driver or a front passenger from moving their seat as far back as recommended, or from locking their seat-back in the desired position.

It can also interfere with proper operation of the passenger's advanced front airbag system.

CONTINUED

Protecting Infants and Small Children

In any of these situations, we strongly recommend that you install the child seat directly behind the front passenger's seat, move the seat as far forward as needed, and leave it unoccupied. Or, you may wish to get a smaller rear-facing child seat.

⚠ WARNING

Placing a rear-facing child seat in the front seat can result in serious injury or death during a crash.

Always place a rear-facing child seat in the back seat, not the front.

Protecting Small Children



Child Seat Type

Many states, Canadian provinces and territories allow a child one year of age or older who also meets the minimum size and weight requirements to transition from a rear-facing child seat to a forward facing seat. Know the requirements where you are driving and follow the child seat instructions. Many experts recommend use of a rear-facing seat up to age two, if the child's height and weight are appropriate for a rear-facing seat.

Of the different seats available, we recommend those that have a five-point harness system as shown.

We also recommend that a small child use the child seat until the child reaches the weight or height limit for the seat.

Child Seat Placement

We strongly recommend placing a forward-facing child seat in a back seat, not the front.

Placing a forward-facing child seat in the front seat of a vehicle equipped with a passenger's airbag can be hazardous. If the vehicle seat is too far forward, or the child's head is thrown forward during a collision, an inflating airbag can strike the child with enough force to cause very serious or fatal injuries.

Even with advanced front airbags that automatically turn the passenger's front airbag off (see page 37), a back seat is the safest place for a small child.

If it is necessary to put a forward-facing child seat in the front, move the vehicle seat as far to the rear as possible, be sure the child seat is firmly secured to the vehicle and the child is properly strapped in the seat.

⚠ WARNING

Placing a forward-facing child seat in the front seat can result in serious injury or death if the front airbag inflates.

If you must place a forward-facing child seat in front, move the vehicle seat as far back as possible, and properly restrain the child.

Selecting a Child Seat

Most child seats are LATCH-compatible (Lower Anchors and Tethers for Children). Some have a rigid-type connector, while others have a flexible-type connector. Both are equally easy to use. Some existing and previously owned child seats can only be installed using the seat belt. Whichever type you choose, follow the child seat manufacturer's use and care instructions as well as the instructions in this manual. Proper installation is key to maximizing your child's safety.

In seating positions and vehicles not equipped with LATCH, a LATCH compatible child seat can be installed using the seat belt and a top tether for added security. This is because all child seats are required to be designed so that they can be secured with a lap belt or the lap part of a lap/shoulder belt.

In addition, the child seat manufacturer may advise that a seat belt be used to attach a LATCH-compatible seat once a child reaches a specified weight. Please read the child seat owner's manual for proper installation instructions.

Important considerations when selecting a child seat

Make sure the child seat meets the following three requirements:

- The child seat is the correct type and size for the child.
- The child seat is the correct type for the seating position.
- The child seat is compliant with Federal Motor Vehicle Safety Standard 213 or Canadian Motor Vehicle Safety Standard 213.

After selecting a proper child seat and a good place to install the seat, there are three main steps in installing the seat:

1. **Properly secure the child seat to the vehicle.** All child seats must be secured to the vehicle with the lap part of a lap/shoulder belt or with the LATCH (Lower Anchors and Tethers for Children) system. A child whose seat is not properly secured to the vehicle can be endangered in a crash.
2. **Make sure the child seat is firmly secured.** After installing a child seat, push and pull the seat forward and from side-to-side to verify that it is secure.

A child seat secured with a seat belt should be installed as firmly as possible. However, it does not need to be “rock solid.” Some side-to-side movement can be expected and should not reduce the child seat's effectiveness.

If the child seat is not secure, try installing it in a different seating position, or use a different style of child seat that can be firmly secured.

3. **Secure the child in the child seat.** Make sure the child is properly strapped in the child seat according to the child seat maker's instructions. A child who is not properly secured in a child seat can be seriously injured in a crash.

The following pages provide guidelines on how to properly install a child seat. A forward-facing child seat is used in all examples, but the instructions are the same for a rear-facing child seat.

Installing a Child Seat

Installing a Child Seat with LATCH

Your vehicle is equipped with LATCH (Lower Anchors and Tethers for Children) at each of the second row seats.

The lower anchors are located between the seat-back and seat bottom, and are to be used only with a child seat designed for use with LATCH.

The location of each lower anchor is indicated by a small button above the anchor point.

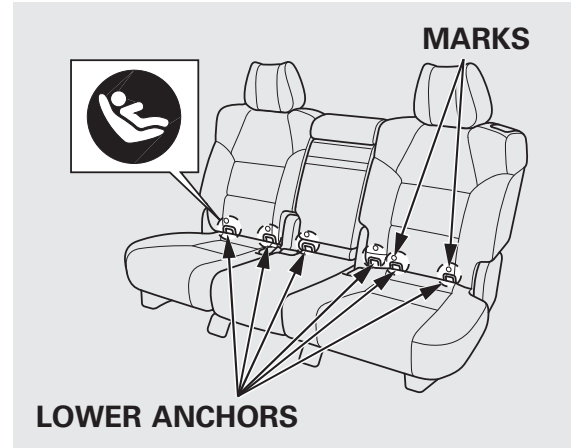

When you install a child seat in the second row seating position, use the lower anchors as shown in the illustration. You can install up to three child seats at a time with LATCH.

Do not attach two child seat connectors to a single lower anchor at a time.

Using the Outer LATCH

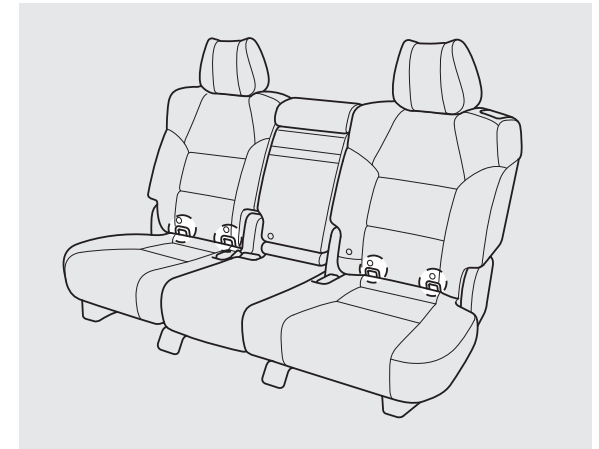

To install a LATCH-compatible child seat in either outer second row seat:

1. Move the seat belt buckle or tongue away from the lower anchors.
2. Make sure there are no objects near the anchors that could prevent a secure connection between the child seat and the anchors.

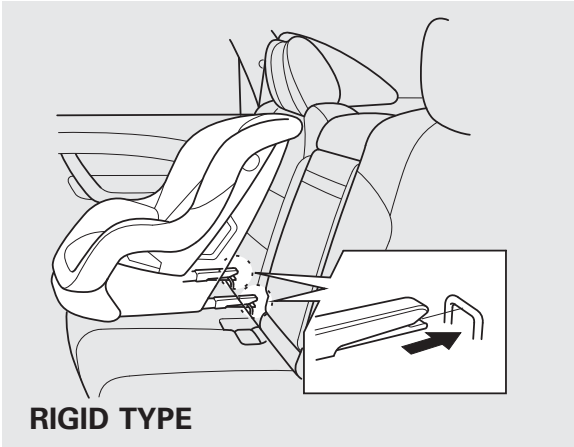

RIGID TYPE

3. Place the child seat on the vehicle seat, then attach the seat to the lower anchors according to the child seat maker's instructions.
Some LATCH-compatible seats have a rigid-type connector as shown above.

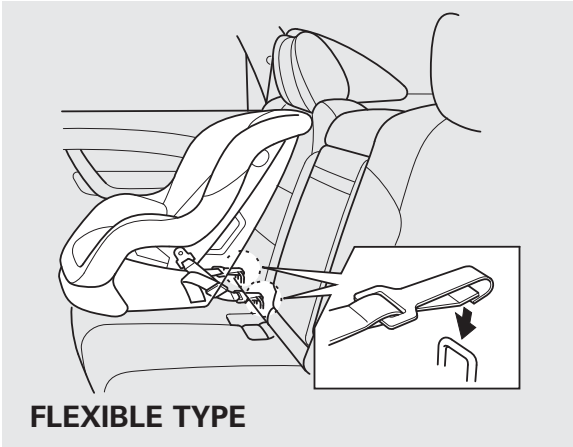

FLEXIBLE TYPE

4. Whatever type you have, follow the child seat maker's instructions for adjusting or tightening the fit.

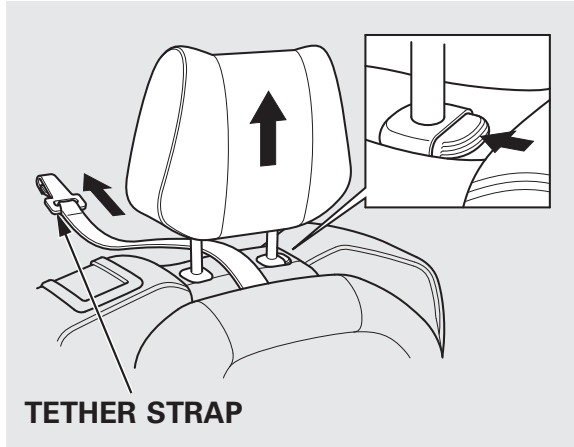

TETHER STRAP

5. Lift the head restraint (see page 150), then route the tether strap through the legs of the head restraint and over the seat-back, making sure the strap is not twisted.

CONTINUED

Installing a Child Seat

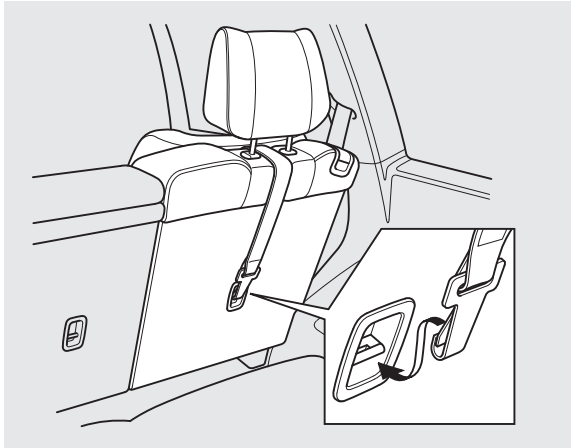

6. Attach the tether strap hook to the tether anchor, then tighten the strap as instructed by the child seat maker.

If the tether strap is too long and cannot be tightened firmly, find a route where the strap can be tightened securely.

7. Push and pull the child seat forward and from side-to-side to verify that it is secure.

Using the Center LATCH

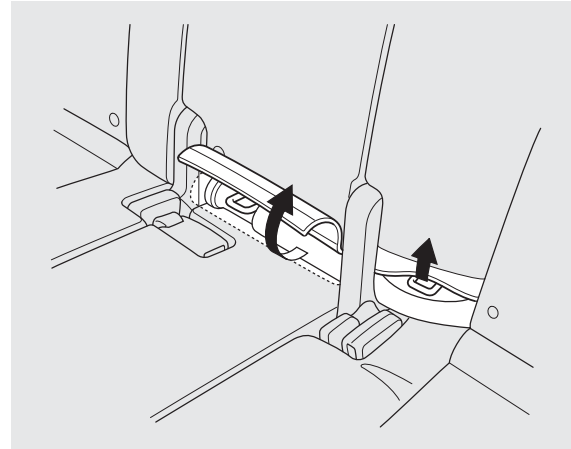

To install a LATCH-compatible child seat in the center seating position on the second row seat, use the center lower anchors as shown above.

1. Pull up the cover below the armrest and find one of the anchors. The other anchor is located underneath the flap at the bottom of the outer seat's inner bolster.
2. Follow step 1 through 4 as described previously to secure the child seat.
3. Lower the head restraint first. Route the tether strap over the head restraint and seat-back, then attach the tether strap hook to the anchor, making sure the strap is not twisted.
4. Push and pull the child seat forward and from side-to-side to verify that it is secure.

Installing a Child Seat with a Lap/Shoulder Belt

When not using the LATCH system, all child seats must be secured to the vehicle with the lap part of a lap/shoulder belt.

In addition, the lap/shoulder belts in all seating positions except the driver's have a lockable retractor that must be activated to secure a child seat.

If you intend to install a child seat in the center seating position of second row seat, make sure the detachable seat belt is securely latched (see page 155).



1. With the child seat in the desired seating position, route the belt through the child seat according to the seat maker's instructions, then insert the latch plate into the buckle and remove any slack from the lap portion of the belt.



2. To activate the lockable retractor, slowly pull the shoulder part of the belt all the way out until it stops, then let the belt feed back into the retractor.

3. After the belt has retracted, tug on it. If the belt is locked, you will not be able to pull it out. If you can pull the belt out, it is not locked, and you will need to repeat these steps.

CONTINUED

Installing a Child Seat

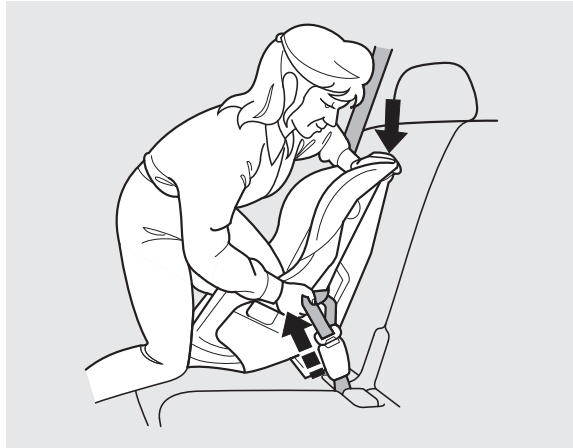

4. After confirming that the belt is locked, grab the shoulder part of the belt near the buckle, and pull up to remove any slack from the lap part of the belt. Remember, if the lap part of the belt is not tight, the child seat will not be secure.

To remove slack, it may help to put weight on the child seat, or push on the back of the seat while pulling up on the belt.



5. Push and pull the child seat forward and from side-to-side to verify that it is secure enough to stay upright during normal driving maneuvers. If the child seat is not secure, unlatch the belt, allow it to retract fully, then repeat these steps.

To deactivate the lockable retractor and remove a child seat, unlatch the buckle, unroute the seat belt, and let the belt fully retract.

Installing a Child Seat with a Tether

A child seat with a tether can be installed in any seating position in the second or third row.

Since a tether can provide additional security to the lap/shoulder belt installation, we recommend using a tether whenever one is required or available.

Second Row Installation

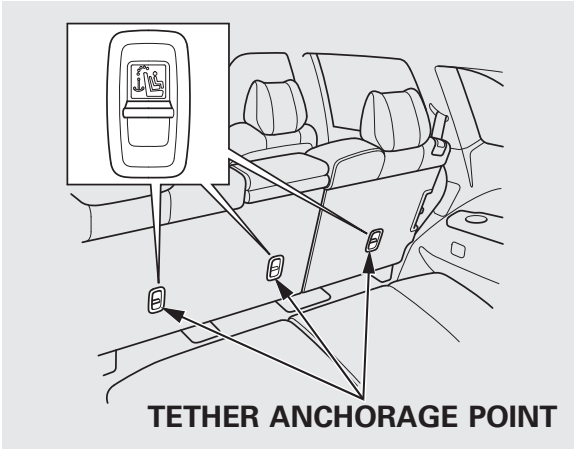

Each second row seat has a tether anchorage point behind the seat-back.

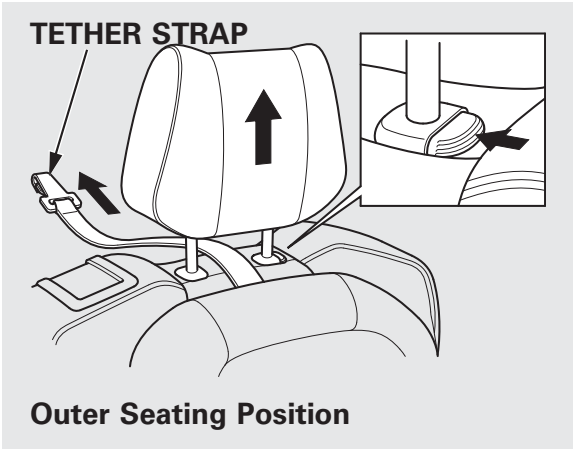

Outer Seating Position

1. After properly securing the child seat (see page 53), lift the head restraint, then route the tether strap over the seat-back and through the head restraint legs.

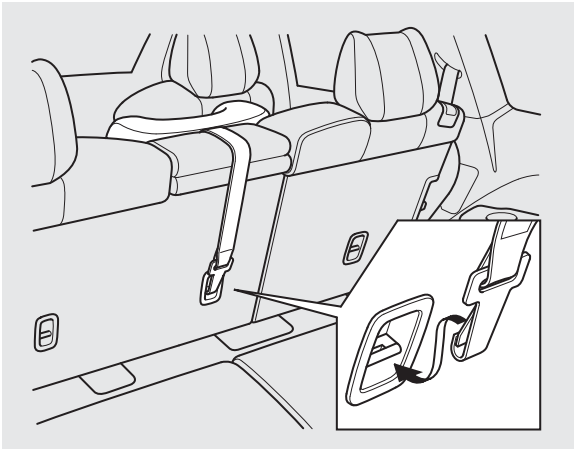

For the center seat, lower the head restraint, then route the tether strap over the head restraint and seat-back.

CONTINUED

Installing a Child Seat

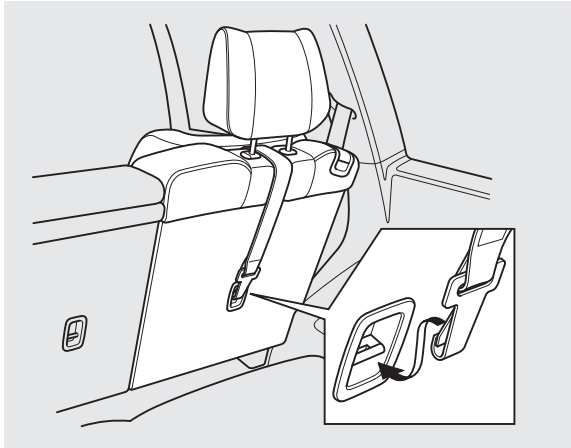

2. Attach the tether strap hook to the anchor, making sure the tether strap is not twisted.
3. Tighten the strap according to the seat maker's instructions.

If the tether strap is too long and cannot be tightened firmly, find a route where the strap can be tightened securely.

Third Row Installation

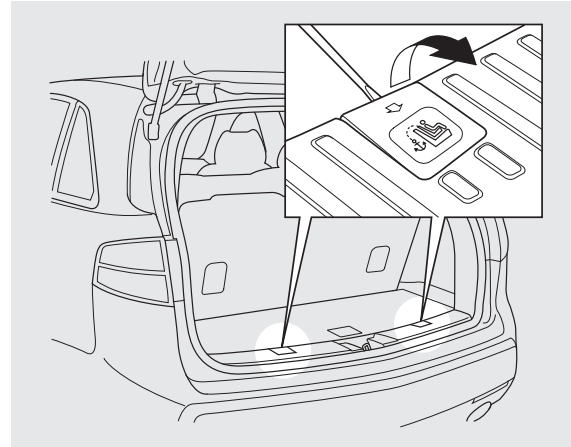

Each third row seat has a tether anchorage point on the tailgate sill.

1. Select the anchor point you want to use. Then open the anchor cover with a small flat-tip screwdriver.
2. Secure the child seat in the desired position (see page 53).

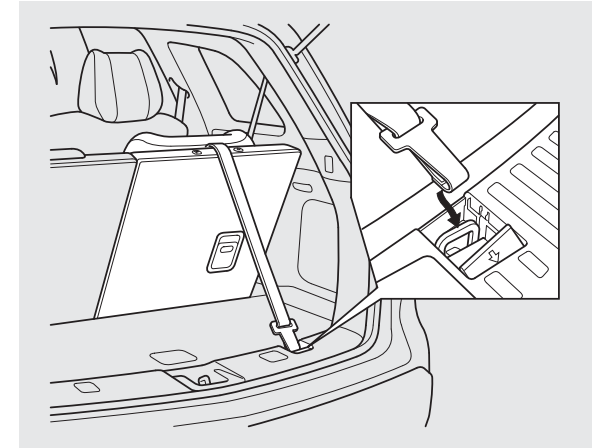

3. Remove the head restraint, then attach the tether strap hook to the anchor, making sure the strap is not twisted.

Make sure the removed head restraint is secured in a safe place.

4. Tighten the strap according to the seat maker's instructions.

If the tether strap is too long and cannot be tightened firmly, find a route where the strap can be tightened securely.

When a child reaches the recommended weight or height limit for a forward-facing child seat, the child should sit in a back seat on a booster seat and wear the lap/shoulder belt.

The following pages give instructions on how to check proper seat belt fit, what kind of booster seat to use if one is needed, and important precautions for a child who must sit in front.

⚠ WARNING

Allowing a child age 12 or under to sit in front can result in injury or death if the passenger's front airbag inflates.

If a child must ride in front, move the vehicle seat as far back as possible, use a booster seat if needed, have the child sit up properly and wear the seat belt properly.

Checking Seat Belt Fit

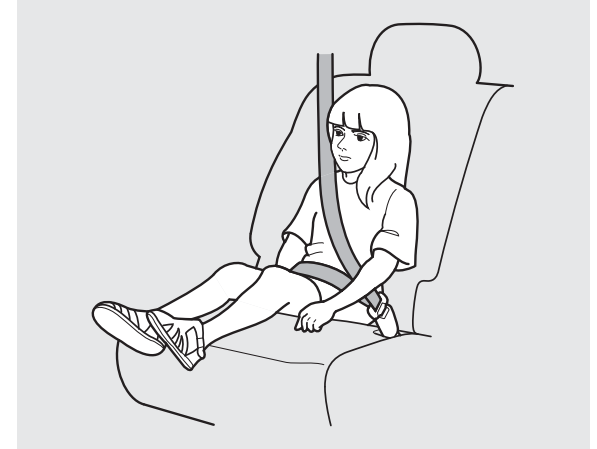

To determine if a lap/shoulder belt properly fits a child, have the child put on the seat belt, then ask yourself:

1. Does the child sit all the way back against the seat?
2. Do the child's knees bend comfortably over the edge of the seat?

CONTINUED

Protecting Larger Children

3. Does the shoulder belt cross between the child's neck and arm?
4. Is the lap part of the belt as low as possible, touching the child's thighs?
5. Will the child be able to stay seated like this for the whole trip?

If you answer yes to all these questions, the child is ready to wear the lap/shoulder belt correctly. If you answer no to any question, the child needs to ride on a booster seat.

Using a Booster Seat



A child who has outgrown a forward-facing child seat should ride in a back seat and use a booster seat until the lap/shoulder belt fits them properly without the booster.

Some states, Canadian provinces and territories also require children to use a booster seat until they reach a given age or weight (e.g., 6 years or 60 lbs). Be sure to check current laws in the states, provinces or territories where you intend to drive.

Booster seats can be high-back or low-back. Whichever style you select, make sure the booster seat meets federal safety standards (see page 48) and that you follow the booster seat maker's instructions.

If a child who uses a booster seat must ride in front, move the vehicle seat as far back as possible and be sure the child is wearing the seat belt properly.

A child may continue using a booster seat until the tops of their ears are even with the top of the vehicle's or booster's seat-back. A child of this height should be tall enough to use the lap/shoulder belt without a booster seat.

When Can a Larger Child Sit in Front

The National Highway Traffic Safety Administration and Transport Canada recommend that all children age 12 and under be properly restrained in a back seat.

If the passenger's front airbag inflates in a moderate to severe frontal collision, the airbag can cause serious injuries to a child who is unrestrained, improperly restrained, sitting too close to the airbag, or out of position.

A side airbag also poses risks. If any part of a larger child's body is in the path of a deploying side airbag, the child could receive possibly serious injuries.

Of course, children vary widely. And while age may be one indicator of when a child can safely ride in front, there are other important factors you should consider.

Physical Size

Physically, a child must be large enough for the lap/shoulder belt to properly fit (see pages 16 and 57). If the seat belt does not fit properly, with or without the child sitting on a booster seat, the child should not sit in front.

Maturity

To safely ride in front, a child must be able to follow the rules, including sitting properly, and wearing the seat belt properly throughout a ride.

CONTINUED

Protecting Larger Children

If you decide that a child can safely ride up front, be sure to:

- Carefully read the owner's manual, and make sure you understand all seat belt instructions and all safety information.
- Move the vehicle seat to the rear-most position.
- Have the child sit up straight, back against the seat, and feet on or near the floor.
- Check that the child's seat belt is properly and securely positioned.
- Supervise the child. Even mature children sometimes need to be reminded to fasten the seat belts or sit properly.

Additional Safety Precautions

- ***Do not let a child wear a seat belt across the neck.*** This could result in serious neck injuries during a crash.
 - ***Do not let a child put the shoulder part of a seat belt behind the back or under the arm.*** This could cause very serious injuries during a crash. It also increases the chance that the child will slide under the belt in a crash and be injured.
 - ***Two children should never use the same seat belt.*** If they do, they could be very seriously injured in a crash.
- ***Do not put any accessories on a seat belt.*** Devices intended to improve a child's comfort or reposition the shoulder part of a seat belt can make the belt less effective and increase the chance of serious injury in a crash.

Your vehicle's exhaust contains carbon monoxide gas. Carbon monoxide should not enter the vehicle in normal driving if you maintain your vehicle properly and follow the information on this page.

Have the exhaust system inspected for leaks whenever:

- The vehicle is raised for an oil change.
- You notice a change in the sound of the exhaust.
- The vehicle was in a crash that may have damaged the underside.

⚠ WARNING

Carbon monoxide gas is toxic. Breathing it can cause unconsciousness and even kill you.

Avoid any enclosed areas or activities that expose you to carbon monoxide.

High levels of carbon monoxide can collect rapidly in enclosed areas, such as a garage. Do not run the engine with the garage door closed. Even with the door open, run the engine only long enough to move the vehicle out of the garage.

With the tailgate open, airflow can pull exhaust gas into your vehicle's interior and create a hazardous condition. If you must drive with the tailgate open, open all the windows, and set the climate control system as shown below.

If you must sit in your parked vehicle with the engine running, even in an unconfined area, adjust the climate control system as follows:

1. Select the fresh air mode.
2. Select the  mode.
3. Turn the fan on high speed.
4. Set the temperature control to a comfortable setting.

Safety Labels

These labels are in the locations shown. They warn you of potential hazards that could cause serious injury or death. Read these labels carefully.

If a label comes off or becomes hard to read (except for the U.S. dashboard label which may be removed by the owner), contact your dealer for a replacement.

DASHBOARD *U.S. models only*

This Vehicle is Equipped with
Advanced Air Bags

Even with Advanced Air Bags
Children can be killed or seriously injured by the air bag.
The back seat is the safest place for children.
Never put a rear-facing child seat in the front.
Always use seat belts and child restraints.
See owner's manual for more information about air bags.

To be removed by owner only.

RADIATOR CAP

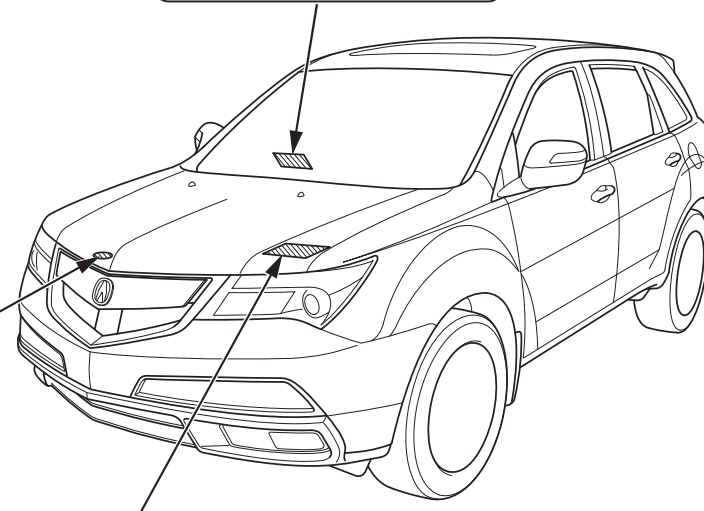

BATTERY LABEL

SUN VISOR
U.S. models

⚠ WARNING

EVEN WITH ADVANCED AIR BAGS



- Children can be killed or seriously injured by the air bag
- The back seat is the safest place for children
- Never put a rear-facing child seat in the front
- Always use seat belts and child restraints
- See owner's manual for more information about air bags

AIR BAG WARNING

FLIP VISOR OVER



Canadian models

<p>CAUTION</p> <p>TO AVOID SERIOUS INJURY:</p> <ul style="list-style-type: none"> FOR MAXIMUM SAFETY PROTECTION IN ALL TYPES OF CRASHES YOU MUST ALWAYS WEAR YOUR SAFETY BELT. DO NOT INSTALL REARWARD-FACING CHILD SEATS IN ANY FRONT PASSENGER SEAT POSITION. DO NOT SIT OR LEAN UNNECESSARILY CLOSE TO THE AIR BAG. DO NOT PLACE ANY OBJECTS OVER THE AIR BAG OR BETWEEN THE AIR BAG AND YOURSELF. SEE THE OWNER'S MANUAL FOR FURTHER INFORMATION AND EXPLANATIONS. 	<p>PRECAUTIONS:</p> <p>POUR EVITER DES BLESSURES GRAVES:</p> <p>POUR PROFITER D'UNE PROTECTION MAXIMALE LORS D'UNE COLLISION BOUCLEZ TOUJOURS VOTRE CEINTURE DE SECURITE.</p> <ul style="list-style-type: none"> N'INSTALLEZ JAMAIS UN SIEGE POUR ENFANTS FAISANT FACE A L'ARRIERE SUR LE SIEGE DU PASSAGER AVANT. NE VOUS APPUYEZ PAS ET NE VOUS ASSOYEZ PAS PRES DU COUSSIN GONFLABLE. NE DEPOSEZ AUCUN OBJET SUR LE COUSSIN GONFLABLE OU ENTRE LE COUSSIN GONFLABLE ET VOUS. LISEZ LE GUIDE UTILISATEUR POUR DE PLUS AMPLES RENSEIGNEMENTS.
---	---

U.S. models

⚠ WARNING: HIGHER ROLLOVER RISK



Avoid Abrupt Maneuvers and Excessive Speed.

Always Buckle Up.

See Owner's Manual For Further Information.



DOORJAMBS

U.S. models

SIDE AIRBAG

- This car is equipped with side airbags in the front seats and side curtain airbags.
- Do not lean against the door.
- See owner's manual for more information.

Canadian models

SIDE AIRBAG

- This car is equipped with side airbags in the front seats and side curtain airbags.
- Do not lean against the door.
- See owner's manual for more information.

COUSSIN GONFLABLE LATERAL

- Cette automobile est équipée de coussins gonflables latéraux dans les sièges avant ainsi que de coussins gonflables latéraux de type rideau.
- Ne vous appuyez pas sur la porte.
- Consultez le Manuel du propriétaire pour en savoir plus.

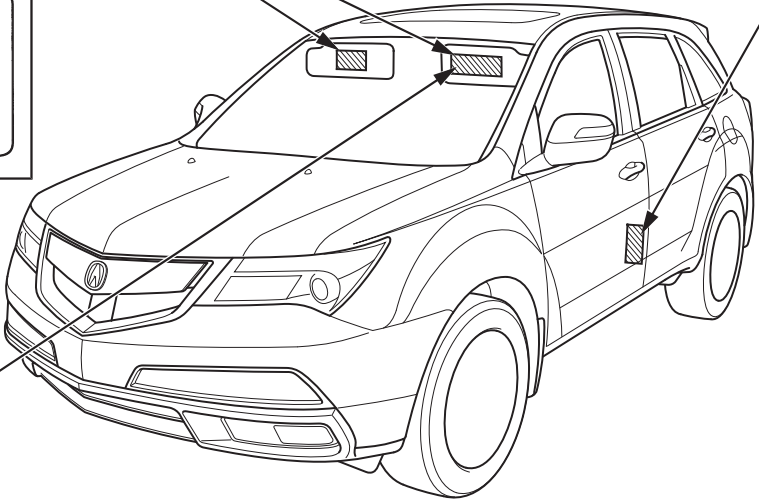

This section gives information about the controls and displays that contribute to the daily operation of your vehicle. All the essential controls are within easy reach.

Control Locations.....	66	Seats	149
Instrument Panel	67	Detachable Anchor	155
Instrument Panel Indicators.....	68	Seat Heaters.....	157
Gauges.....	78	Seat Heaters and Seat	
Multi-Information Display	79	Ventilation.....	158
Controls Near the Steering		Power Windows	160
Wheel	125	Moonroof.....	163
Windshield Wipers and		Parking Brake.....	164
Washers	126	Mirrors	165
Rear Window Wiper and		Driving Position Memory	
Washer	127	System	168
Turn Signal and Headlights	128	Interior Lights.....	170
Hazard Warning Button	132	Interior Convenience Items.....	173
Rear Window Defogger.....	132	Beverage Holders	174
Instrument Panel Brightness	133	Console Compartment	175
Steering Wheel Adjustments.....	134	Storage Compartment.....	175
Keys and Locks.....	136	Glove Box	175
Immobilizer System	138	Sunglasses Holder	176
Ignition Switch	139	Sun Visor	176
Door Locks	140	Vanity Mirror	177
Childproof Door Locks.....	141	Accessory Power Sockets	177
Tailgate	141	AC Power Outlet.....	178
Power Tailgate	142		
Remote Transmitter	145		

Control Locations

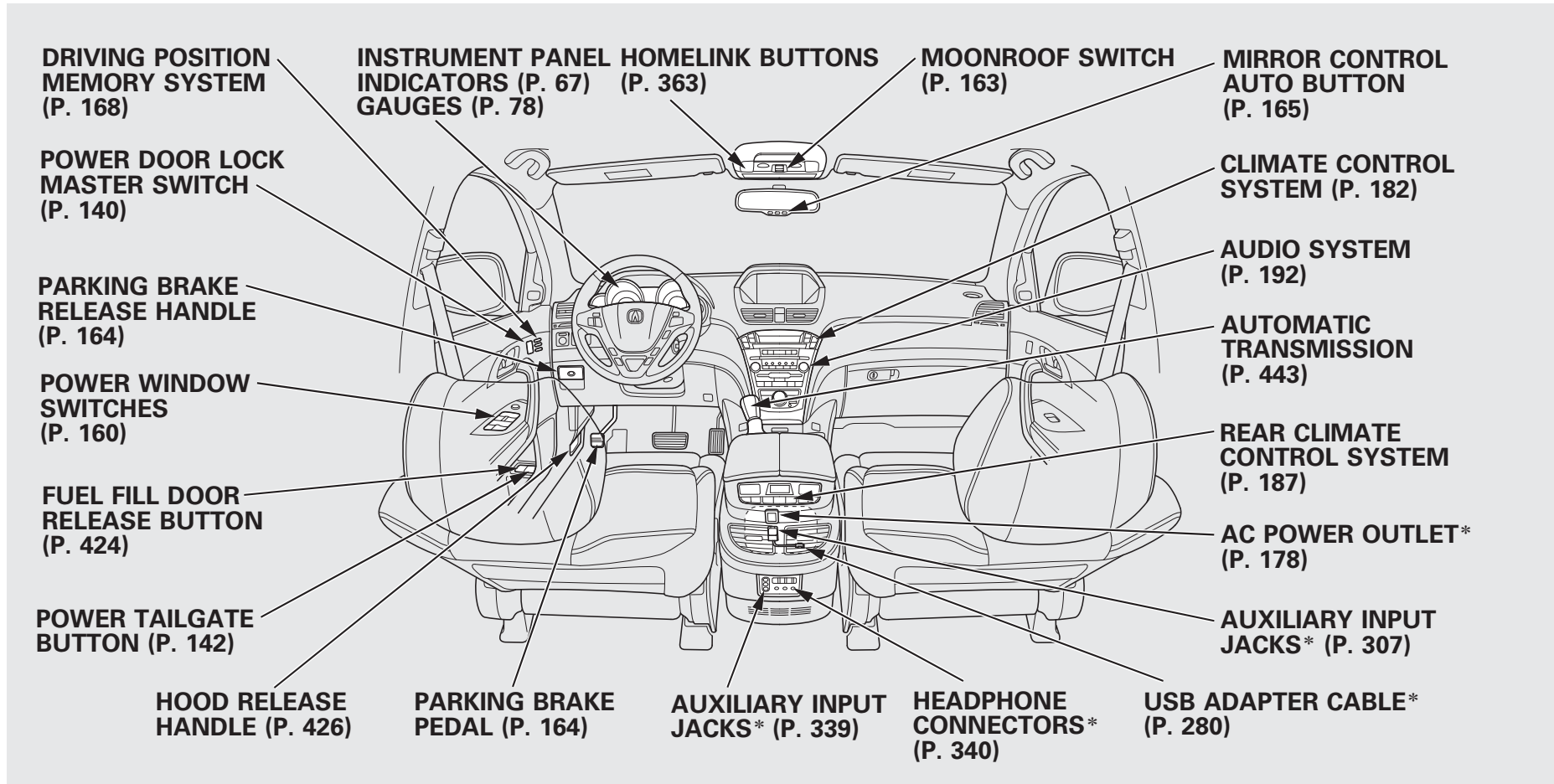

*: If equipped

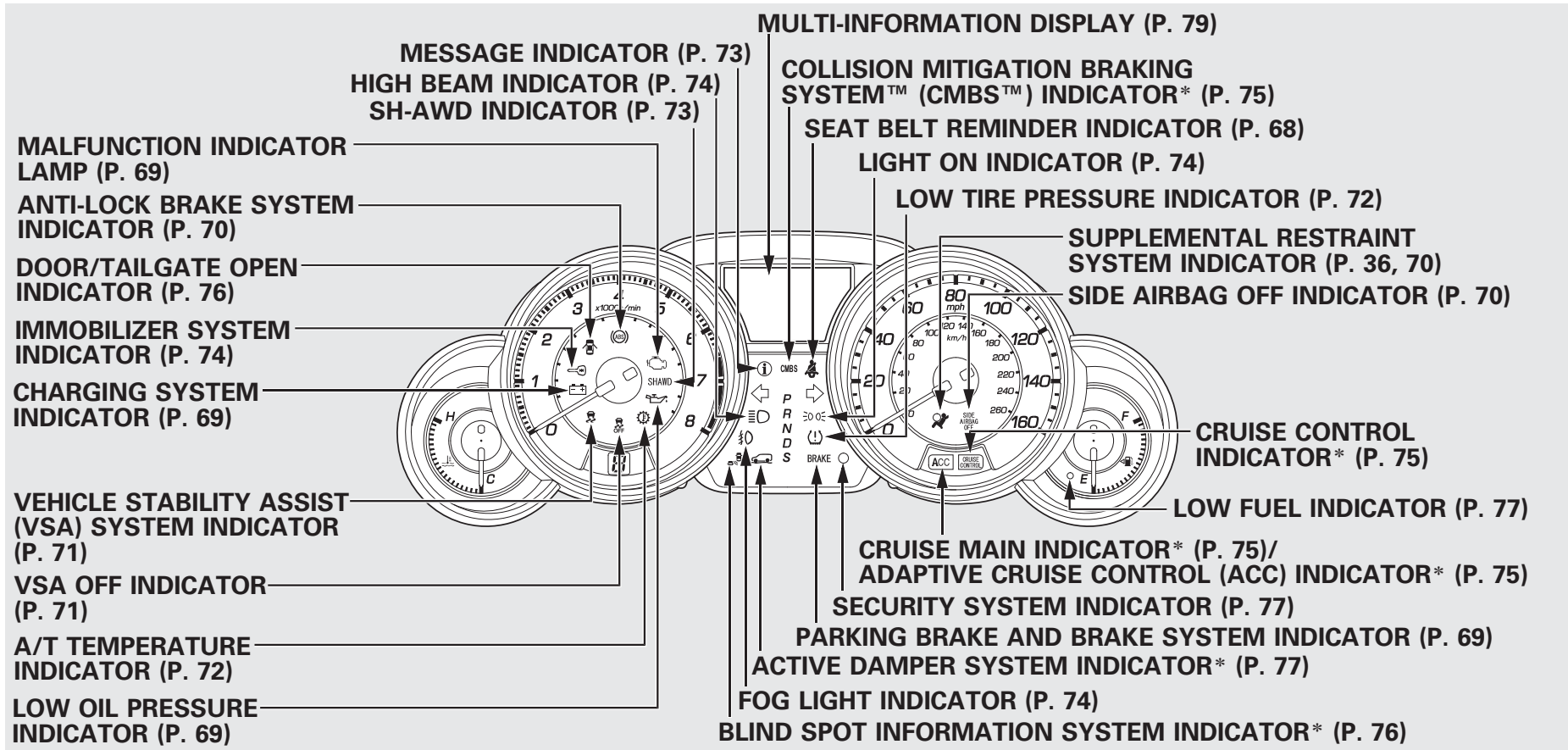

*: If equipped

The U.S. instrument panel is shown. Differences for the Canadian models are noted in the text.

Instrument Panel Indicators

The instrument panel has many indicators to give you important information about your vehicle.



Seat Belt Reminder Indicator

This indicator comes on when you turn the ignition switch to the ON (II) position. It reminds you and your passengers to fasten your seat belts. A beeper also sounds if you have not fastened your seat belt.

If you turn the ignition switch to the ON (II) position before fastening your seat belts, the beeper sounds, and the indicator flashes. If you do not fasten your seat belts before the beeper stops, the indicator stops flashing but remains on.

If your front passenger does not fasten their seat belt, the indicator comes on about 6 seconds after the ignition switch is turned to the ON (II) position.

If either of you do not fasten your seat belt while driving, the beeper will sound and the indicator will flash again at regular intervals, and you will see a “FASTEN SEAT BELT” or “FASTEN PASSENGER SEAT BELT” message on the multi-information display (see page 87).

For more information, see page 21.



Low Oil Pressure Indicator

The engine can be severely damaged if this indicator flashes or stays on when the engine is running, or if a “CHECK ENGINE OIL LEVEL” message is on the multi-information display. For more information, see page 562.



Charging System Indicator

If it comes on when the engine is running, the battery is not being charged, and you will see a “CHECK CHARGING SYSTEM” message on the multi-information display. For more information, see page 562.



Malfunction Indicator Lamp

You will also see a “CHECK EMISSION SYSTEM” message on the multi-information display. For more information, see page 563.



Parking Brake and Brake System Indicator

This indicator has two functions:

1. It comes on when you turn the ignition switch to the ON (II) position. It is a reminder to check the parking brake. Driving with the parking brake not fully released can damage the rear brakes, axles, and tires.

If you drive without releasing the parking brake, a beeper will sound, and you will also see a “RELEASE PARKING BRAKE” message on the multi-information display (see page 87).

2. If it stays on after you have fully released the parking brake while the engine is running, or if it comes on while driving, it can indicate a problem in the brake system. You will also see a “LOW BRAKE FLUID” or “CHECK BRAKE SYSTEM” message on the multi-information display (see pages 87). For more information, see page 564.

CONTINUED

Instrument Panel Indicators



Supplemental Restraint System Indicator

This indicator comes on briefly when you turn the ignition switch to the ON (II) position. If it comes on at any other time, it indicates a potential problem with your front airbags. This indicator will also alert you to a potential problem with your airbag system components. You will also see a “CHECK AIRBAG SYSTEM” message on the multi-information display (see page 87). For more information, see page 36.

U.S.



Canada



Side Airbag Off Indicator

This indicator comes on when you turn the ignition switch to the ON (II) position. If it comes on at any other time, it indicates that the passenger's side airbag has automatically shut off. You will also see a “PASSENGER SIDE AIRBAG OFF” message on the multi-information display (see page 87). For more information, see page 36.



Anti-lock Brake System (ABS) Indicator

This indicator normally comes on for a few seconds when you turn the ignition switch to the ON (II) position. If this indicator comes on at any other time, there is a problem in the ABS. If this happens, take the vehicle to your dealer to have it checked. With this indicator on, your vehicle still has normal braking ability but no anti-lock function. You will also see a “CHECK ABS SYSTEM” message on the multi-information display (see page 88). For more information, see page 461.



Vehicle Stability Assist (VSA) System Indicator

This indicator normally comes on for a few seconds when you turn the ignition switch to the ON (II) position. It flashes when VSA is active (see page 473).

If it comes on and stays on at any other time, there is a problem with the VSA or Hill Start Assist system. You will also see a “CHECK VSA SYSTEM” message on the multi-information display (see page 88). Take your vehicle to a dealer to have it checked. Without VSA, your vehicle still has normal driving ability, but will not have VSA traction and stability enhancement. For more information, see page 473.

This indicator may also come on if there is a problem with the trailer stability assist function (see page 498).



VSA Off Indicator

It comes on as a reminder that you have turned off the vehicle stability assist (VSA) system.

This indicator normally comes on for a few seconds when you turn the ignition switch to the ON (II) position. For more information, see page 473.

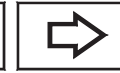

Turn Signal and Hazard Warning Indicators

The left or right turn signal indicator blinks when you signal a lane change or turn. If an indicator does not blink or blinks rapidly, it usually means one of the turn signal bulbs is burned out (see page 529). Replace the bulb as soon as possible, since other drivers cannot see that you are signaling.

When you press the hazard warning button, both turn signal indicators and all turn signals on the outside of the vehicle flash.

CONTINUED

Instrument Panel Indicators



Low Tire Pressure/ TPMS Indicator

This indicator normally comes on for a few seconds when you turn the ignition switch to the ON (II) position.

This indicator has two functions:

1. If it comes on while driving, it indicates that one or more of your vehicle's tires are significantly low on pressure.

You will also see a “CHECK TIRE PRESSURE” message on the multi-information display (see page 88).

Check the tire pressure monitor on the multi-information display and determine the cause (see page 456).

If this happens, pull to the side of the road when it is safe, check which tire has lost pressure on the multi-information display, and determine the cause. If it is because of a flat tire, have the flat tire repaired as soon as possible. If two or more tires are underinflated, call a professional towing service. For more information, see page 572.

2. If this indicator begins to flash, there is a problem with the tire pressure monitoring system (TPMS). You will also see a “CHECK TPMS SYSTEM” message on the multi-information display. The indicator continues to flash for a while (approximately 1 minute), then stays on. If this happens, have your dealer check the system as soon as possible. For more information, see page 458.



A/T Temperature Indicator

This indicator monitors the temperature of the automatic transmission fluid. It should come on for a few seconds when you turn the ignition switch to the ON (II) position. If it comes on while driving, it means the transmission fluid temperature is too high. Pull to the side of the road when it is safe, shift to Park, and let the engine idle until the indicator goes out.

You will also see an “A/T TEMP HIGH” message on the multi-information display (see page 88).

NOTICE

Continuing to drive with the A/T temperature indicator on may cause serious damage to the transmission.



Message Indicator

This indicator comes on when there is a system message on the multi-information display. Press the INFO button on the steering wheel (see page 79) to see the message (see page 87).

Most of the time, this indicator comes on along with other indicators in the instrument panel such as the seat belt reminder indicator, SRS indicator, VSA system indicator, etc.



Super Handling-All Wheel Drive (SH-AWD) Indicator

This indicator normally comes on for a few seconds when you turn the ignition switch to the ON (II) position. If this indicator comes on at any other time, there is a problem in the SH-AWD system. You will also see a “CHECK SH-AWD SYSTEM” message on the multi-information display (see page 88). Take your vehicle to a dealer to have it checked. For more information, see page 452.

If the indicator blinks while driving, it indicates the differential temperature is too high.

You will also see a “SH-AWD DIFF TEMP. HIGH” message on the multi-information display (see page 88).

Pull to the side of the road when it is safe, shift to Park, and let the engine idle until the indicator goes out.

NOTICE

Continuing to drive with the SH-AWD indicator blinking may cause serious damage to the system.

CONTINUED

Instrument Panel Indicators

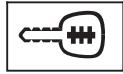

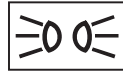

Immobilizer System Indicator

This indicator comes on briefly when you turn the ignition switch to the ON (II) position. It will then go off if you have inserted a properly coded ignition key. If it is not a properly coded key, the indicator will blink, and the engine's fuel system will be disabled (see page 138).

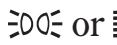

Lights On Indicator

This indicator reminds you that the exterior lights are on. It comes on when the light switch is in either the  or  position. This indicator will also come on when the light switch is in AUTO and the lights turn on automatically. If you turn the ignition switch to the ACCESSORY (I) or the LOCK (0) position without turning off the light switch, this indicator will remain on. A reminder chime will also sound when you open the driver's door.



Fog Light Indicator

This indicator comes on when you turn on the fog lights. For more information, see page 130.



High Beam Indicator

This indicator comes on with the high beam headlights. For more information, see page 128.

ACC Adaptive Cruise Control (ACC) Indicator

On models with adaptive cruise control (ACC)

This indicator normally comes on for a few seconds when you turn the ignition switch to the ON (II) position.

When you push the MAIN button on the steering wheel, this indicator comes on green. You will also see “ACC” on the multi-information display.

If the indicator comes on amber, there is a problem with the ACC system. You will also see a “CHECK ACC SYSTEM” message on the multi-information display (see page 88). Take your vehicle to your dealer to have it checked. For more information, see page 348.

CRUISE MAIN Cruise Main Indicator

On models without adaptive cruise control (ACC)

This indicator comes on when you turn on the cruise control system by pressing the CRUISE button (see page 345).

CRUISE CONTROL Cruise Control Indicator

On models without adaptive cruise control (ACC)

This indicator comes on when you set the cruise control. See page 345 for information on operating the cruise control.

CMBS Collision Mitigation Braking System™ (CMBS™) Indicator

On models with collision mitigation braking system™ (CMBS™)

This indicator normally comes on for a few seconds when you turn the ignition switch to the ON (II) position. It also comes on as a reminder that you have turned off the collision mitigation braking system™ (CMBS™).

The CMBS indicator also comes on if dirt or other debris blocks the radar sensor in the front grille. You will also see a “CHECK CMBS RADAR SENSOR” message on the multi-information display. When you clean the radar sensor, the indicator should go off the next time you turn the ignition switch to the ON (II) position.

CONTINUED

Instrument Panel Indicators

If the indicator comes on at any other time, there is a problem with the CMBS. You will also see a “CHECK CMBS SYSTEM” message on the multi-information display. If this happens, take your vehicle to your dealer, and have it checked. For more information, see page 463. When this indicator is on, the CMBS is not working.



Door/Tailgate Open Indicator

This indicator comes on red if any door or the tailgate is not closed tightly.

You will also see a corresponding indicator(s) on the multi-information display to indicate which door and/or the tailgate is not closed tightly (see page 12).



Blind Spot Information System (BSI) Indicator

On models with blind spot information system (BSI)

This indicator normally comes on for a few seconds when you turn the ignition switch to the ON (II) position.

The BSI indicator also comes on if the rear bumper becomes dirty while driving. You will see a “BLIND SPOT NOT AVAILABLE” message on the multi-information display.

When you clean the rear bumper, the indicator should go off after you begin driving again.

When you turn the system on, the indicator will turn off.

If the indicator comes on at any other time, there is a problem with BSI. You will also see a “CHECK BLIND SPOT SYSTEM” message on the multi-information display. If this happens, take your vehicle to a dealer, and have it checked (For more information, see page 482). When this indicator is on, BSI is not working.



Active Damper System Indicator

If equipped

This indicator comes on briefly when you turn the ignition switch to the ON (II) position. If this indicator comes on at any other time, there is a problem in the system. While this indicator is on, the comfort button will not work, and the system will remain in the sport mode. You will also see a “CHECK ADS SYSTEM” message on the multi-information display. Have the vehicle checked by your dealer as soon as possible. For more information, see page 484.

Low Fuel Indicator

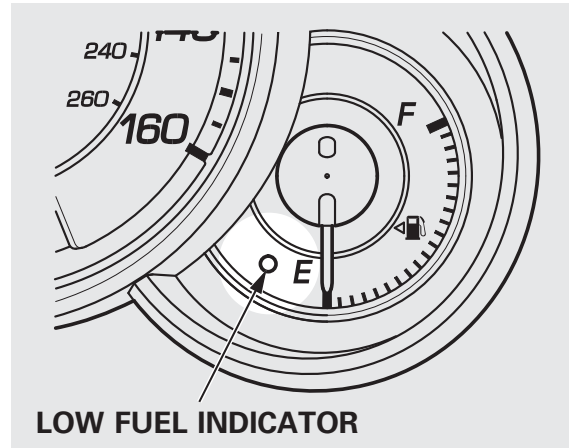

This indicator comes on as a reminder that you must refuel soon.

When the indicator comes on, there is about 2.9 U.S. gal (10.8 L) of fuel remaining in the tank.

When the needle reaches E, there is a very small amount of fuel in the tank.

Security System Indicator

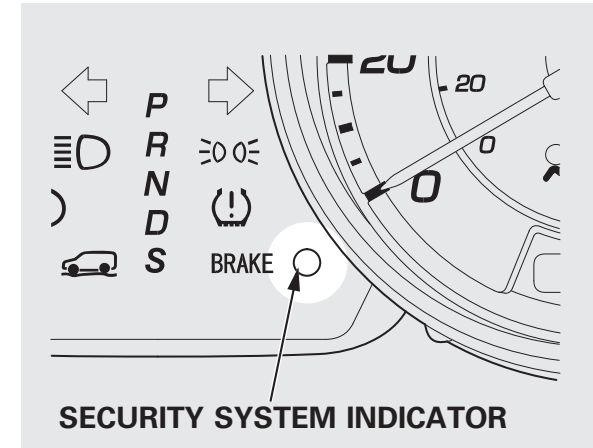

This indicator comes on when the security system is set. See page 341 for more information on the security system.

Gauges

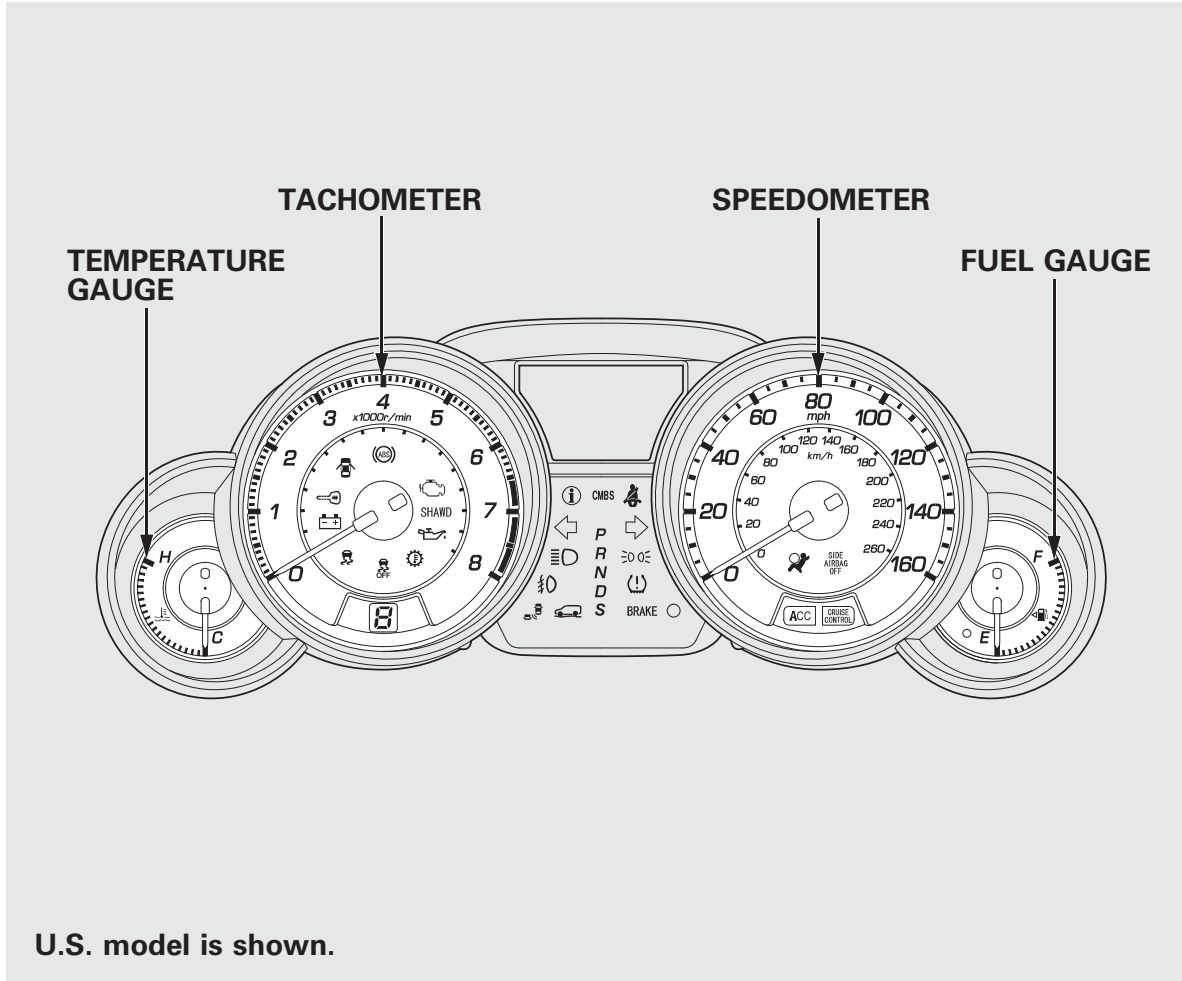

Temperature Gauge

This shows the temperature of the engine's coolant. During normal operation, the pointer should rise to about the middle of the gauge. In severe driving conditions, the pointer may rise to the upper zone. If it reaches the red (hot) mark, pull safely to the side of the road. For instructions and precautions on checking the engine's cooling system, see page 560.

Fuel Gauge

This shows how much fuel you have. It may show slightly more or less than the actual amount.

NOTICE

Avoid driving with an extremely low fuel level. Running out of fuel could cause the engine to misfire, damaging the catalytic converter.

The multi-information display in the instrument panel displays various information and messages when the ignition switch is in the ON (II) position. Some of the messages help you operate your vehicle more comfortably. Others help to keep you aware of the periodic maintenance your vehicle needs for continued trouble-free driving.

When you open the driver's door, a "Welcome" message is shown on the multi-information display.

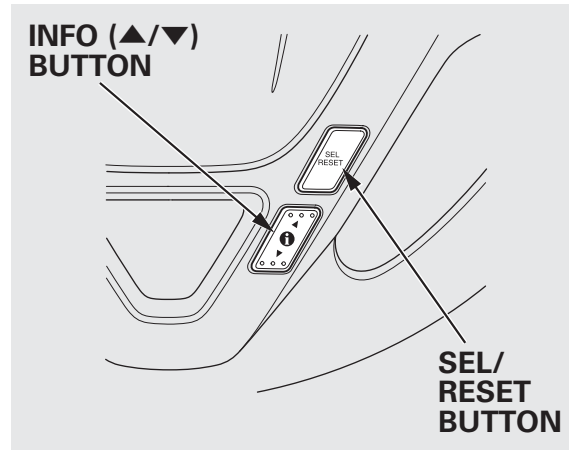

To change the display, press the INFO (▲/▼) button on the steering wheel repeatedly until the main menu appears (see page 80).

With the ignition switch in the ON (II) position, the multi-information display changes as shown on the next page each time you press the INFO (▲/▼) button or SEL/RESET button.

When you turn the ignition switch to the ON (II) position, your last selection is displayed.

In the multi-information display, the system message is also displayed (see page 86) and you can customize your vehicle control settings (see page 90).

CONTINUED

Multi-Information Display

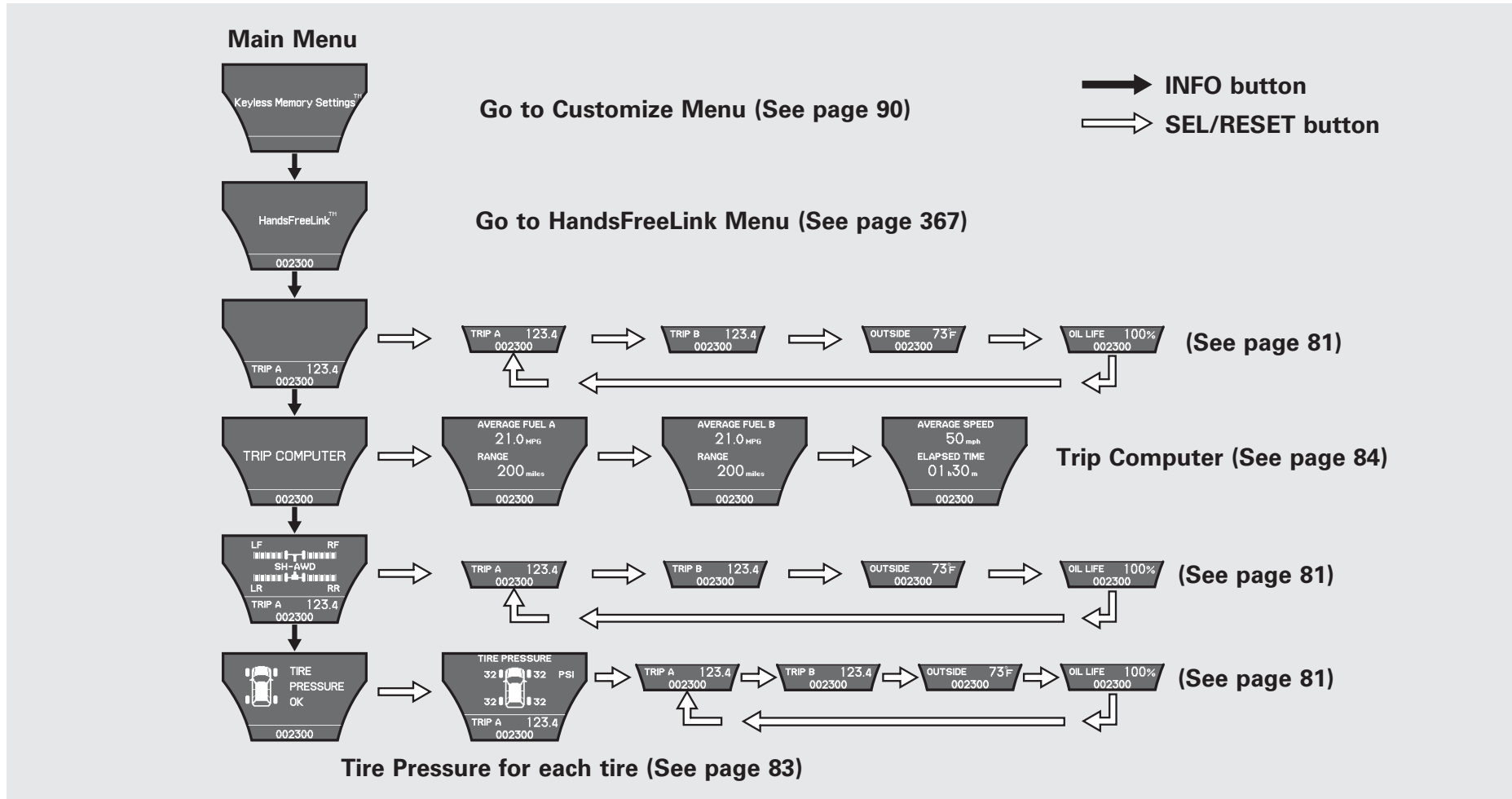

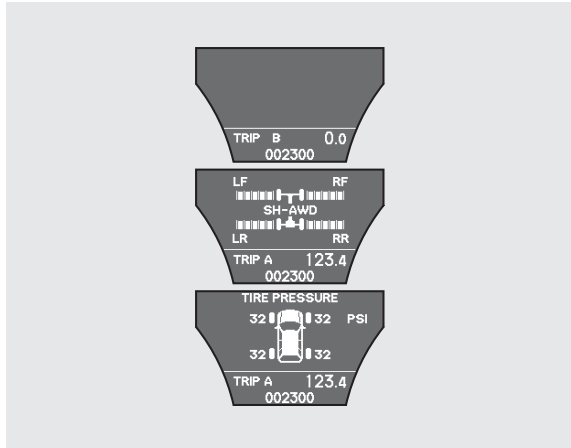

When the main menu is blank, pressing the SEL/RESET button changes the display to “trip meter/odometer” “outside temperature/odometer” and “engine oil life/odometer”.

Odometer

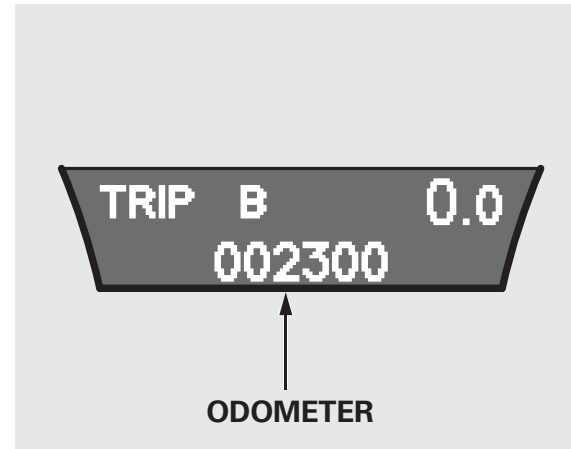

The odometer shows the total distance your vehicle has been driven. It measures miles in U.S. models and kilometers in Canadian models. It is illegal under U.S. federal law and Canadian provincial/territorial regulations to disconnect, reset, or alter the odometer with the intent to change the number of miles or kilometers indicated.

Trip Meter

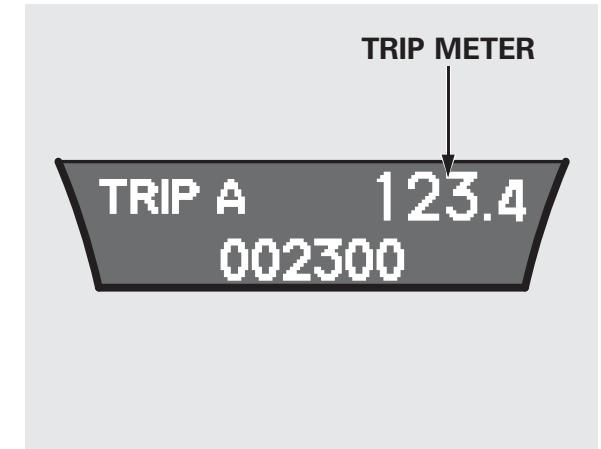

This meter shows the number of miles (U.S.) or kilometers (Canada) driven since you last reset it. There are two trip meters: Trip A and Trip B. Each trip meter works independently, so you can keep track of two different distances.

To reset a trip meter, display it, and then press and hold the SEL/RESET button until the number resets to “0.0.”

CONTINUED

Multi-Information Display

When you reset Trip A, average fuel economy A is reset at the same time. When you reset Trip B, average fuel economy B is reset.

In the customizing mode, you can set Trip A and average fuel economy A to reset at the same time when you refuel your vehicle (see page 102).

Outside Temperature

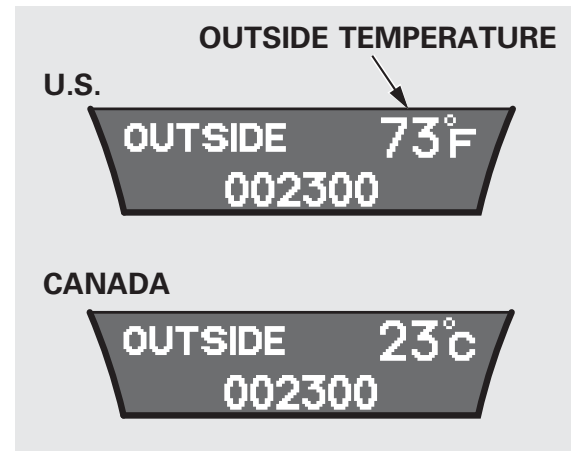

This shows the outside Fahrenheit temperature in U.S. models, and Celsius temperature in Canadian models.

The temperature sensor is in the front bumper. The temperature reading can be affected by heat reflection from the road surface, engine heat, and the exhaust from surrounding traffic. This can cause an incorrect temperature reading when your vehicle speed is under 19 mph (30 km/h). When you start your trip, the sensor is not fully acclimatized, therefore it may take several minutes until the proper temperature is displayed.

In certain weather conditions, temperature readings near freezing (32°F, 0°C) could mean that ice is forming on the road surface. You can adjust the outside temperature display (see page 101).

Engine Oil Life

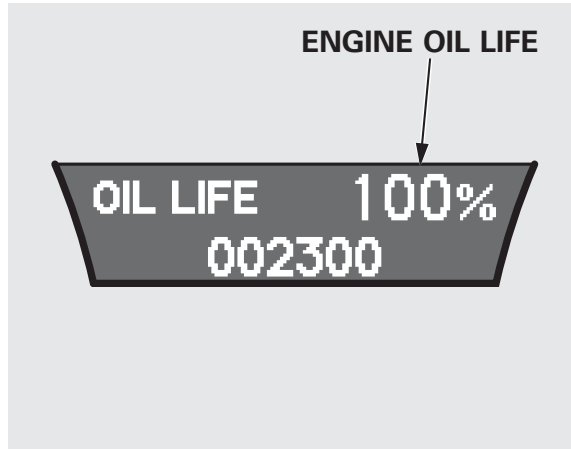

This shows the remaining life of the engine oil. It shows 100% after the engine oil is replaced and the display is reset. The engine oil life is calculated based on engine operating conditions and accumulated engine revolutions. For more information, see page 507.

SH-AWD Torque Distribution Monitor

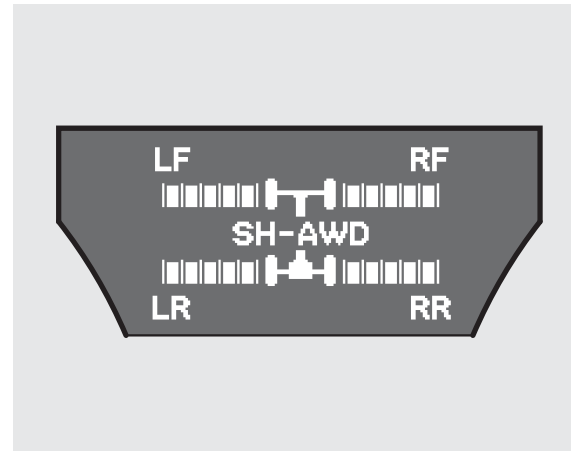

This monitor shows how much torque is being delivered to each wheel. For more information, see page 452.

Tire Pressure Monitor

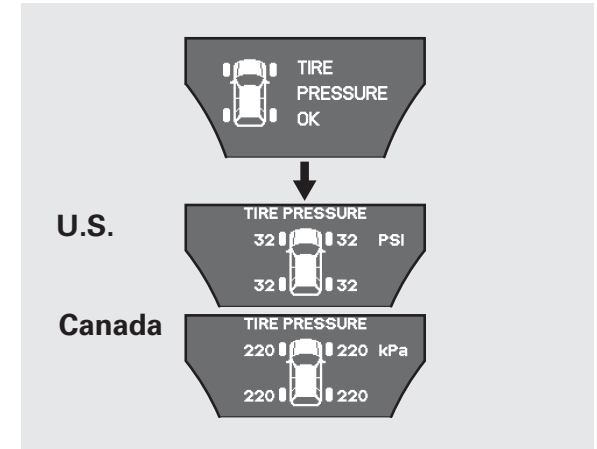

When the tire pressure monitor is shown on the multi-information display, press the SEL/RESET button. The display changes as shown.

You can see the pressure of each tire in this monitor. If one or more tires are low, inflate them to the correct pressure. For more information, see page 455.

CONTINUED

Multi-Information Display

HandsFreeLink™

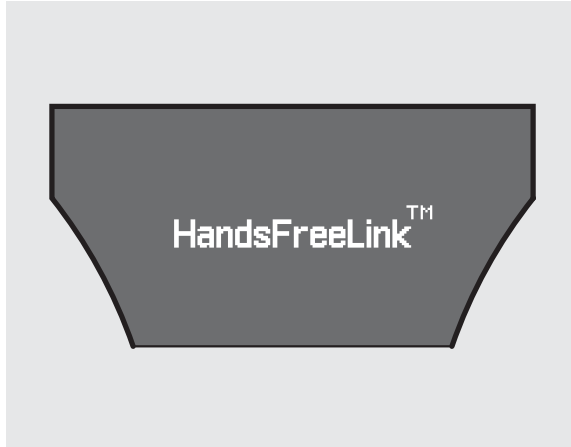

You can receive or make phone calls from your cell phone through your vehicle's *Bluetooth*® HandsFreeLink® (HFL) system without touching your cell phone.

Trip Computer

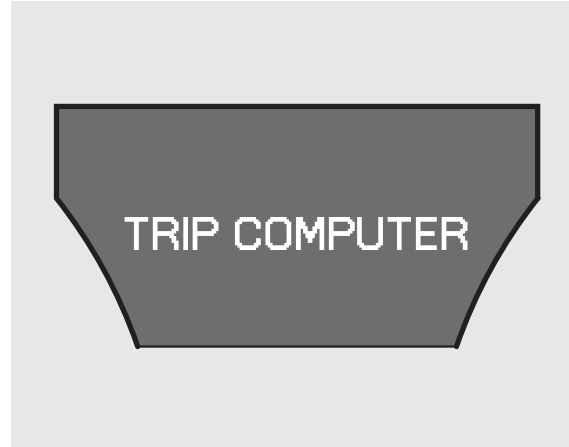

When the main menu displays "TRIP COMPUTER", pressing the SEL/RESET button changes the display to "AVERAGE FUEL A/RANGE" to "AVERAGE FUEL B/RANGE" and to "AVERAGE SPEED/ELAPSED TIME".

AVERAGE FUEL A/B

This shows your vehicle's average fuel economy in mpg (U.S. models) or liter/100 km (Canadian models) since you last reset the Trip A or Trip B.

You can customize the Trip A and AVERAGE FUEL A reset condition on the multi-information display (see page 102).

RANGE

This shows the estimated distance you can travel on the fuel remaining in the fuel tank. This distance is estimated from the fuel economy you received over the last several miles (U.S.) or kilometers (Canada), so it will vary with changes in speed, traffic, etc.

AVERAGE SPEED

This shows the average speed you are traveling in miles per hour (mph) for U.S. models or kilometers per hour (km/h) for Canadian models.

To reset the AVERAGE SPEED you have traveled, press and hold the SEL/RESET button until the number resets.

ELAPSED TIME

This shows the time passed traveled since you last reset it. When you turn the ignition switch to the ON (II) position, ELAPSED TIME is reset.

If you want to reset the ELAPSED TIME manually, go to the trip computer's ELAPSED TIME display, and press and hold the SEL/RESET button until the number resets.

You can customize the ELAPSED TIME reset condition on the multi-information display (see page 104).

CONTINUED

Multi-Information Display

System Messages

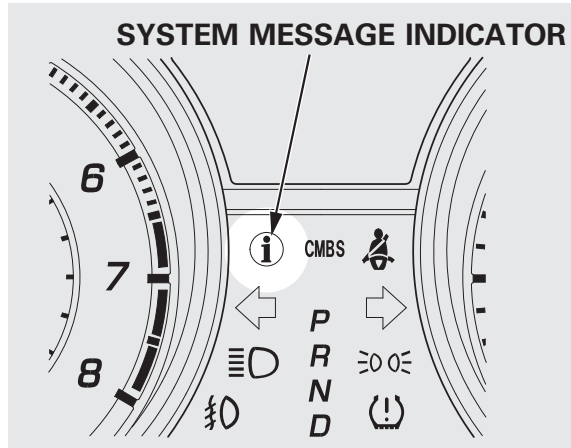

If there is a problem with your vehicle, for example, the engine oil level is low or a door is not fully closed, the multi-information display will show you the problem. It does this by interrupting the current display with one or more messages.

The system message(s) triggers the appropriate indicator(s) on the instrument panel, including the system message indicator, to come on. The system message indicator does not go off until the problem(s) is corrected.

You will also hear a beep when the system message comes on for the first time.

Most of the messages are displayed for about 5 seconds, and then the normal display returns. If there are several system messages to be shown, the display switches these messages every 5 seconds.







To cancel the message(s) before 5 seconds have elapsed, press the INFO (▲/▼) button on the steering wheel.



Even if you press the INFO (▲/▼) button, some messages stay on or come on again at regular intervals until the problem is corrected.





You can see the message(s) again by pressing the INFO (▲/▼) button repeatedly if the system message indicator remains lit on the instrument panel.

Here is a list of all messages:

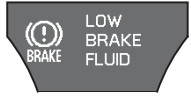
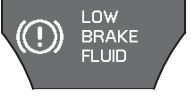
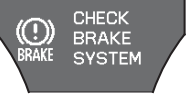
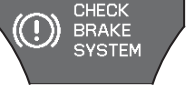
Multi-Information Display

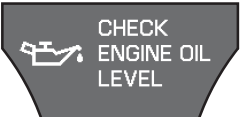



	See page 12
	See page 21
	See page 21
	See page 36
<p>U.S.</p>  <p>Canada</p> 	See page 36







<p>U.S.</p> 	See page 164
<p>Canada</p> 	
<p>U.S.</p> 	See page 564
<p>Canada</p> 	
<p>U.S.</p> 	See page 564
<p>Canada</p> 	







	See page 562
	See page 562
	See page 563
	See Page 443
	See page 130
	





CONTINUED

Multi-Information Display

 CHECK ABS SYSTEM	See page 462
 CHECK VSA SYSTEM	See page 473
CHECK TRAILER STABILITY ASSIST	See page 499
 CHECK TIRE PRESSURE	See page 456
 CHECK TPMS SYSTEM	See page 458
 SYSTEM FUNCTION ERROR	See page 456

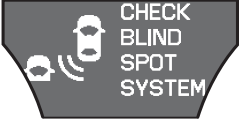
 A/T TEMP HIGH	See page 72
U.S.  CHECK POWER TAILGATE	See page 144
Canada  CHECK POWER TAILGATE	
 CHECK SH-AWD SYSTEM	See page 452
 SH-AWD DIFF TEMP. HIGH	See page 452
 CHECK TRANSMISSION	See page 443

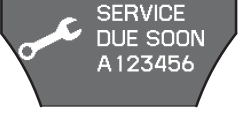
 CHECK ADS SYSTEM	See page 486
 LOW WASHER FLUID	See page 522
 LOW FUEL	See page 77
 CHECK ACC SYSTEM	See page 360
 CHECK CMBS RADAR SENSOR	See page 75
 CHECK CMBS SYSTEM	See page 467

 <p>CHECK BLIND SPOT SYSTEM</p>	See page 482
 <p>BLIND SPOT NOT AVAILABLE</p>	See page 482
 <p>CHECK BATTERY SENSOR</p>	See page 547
 <p>SERVICE DUE SOON A 123456</p>	See page 507
 <p>TIGHTEN FUEL CAP</p>	See page 425

CONTINUED

Multi-Information Display

Customize Settings

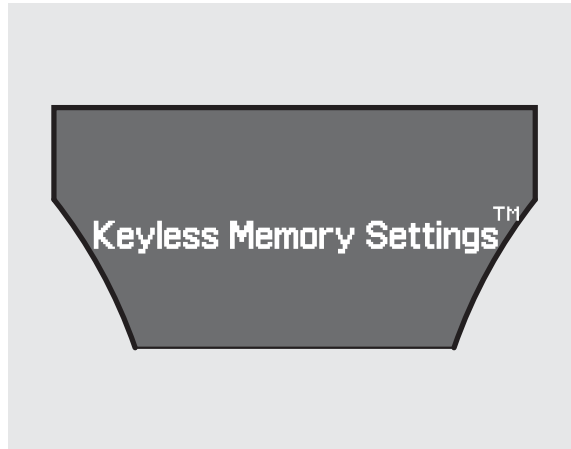

When the main menu displays “Keyless Memory Settings™,” you can customize some vehicle control settings.

To enter the customizing mode, press the SEL/RESET button.

To change the settings, the ignition switch must be in the ON (II) position, and the vehicle must be stopped with the transmission in Park.

If you turn the ignition switch to the ACCESSORY (I) or the LOCK (0) position, or move the shift lever out of Park, the display will change to the normal screen.

You can customize some vehicle control settings for “DRIVER 1” and “DRIVER 2” separately. If “DRIVER 1” or “DRIVER 2” is not displayed, customizing is not possible.

To have the driver's ID detected, make sure your remote transmitter is linked to the system (see Keyless Memory Settings™ on page 148).

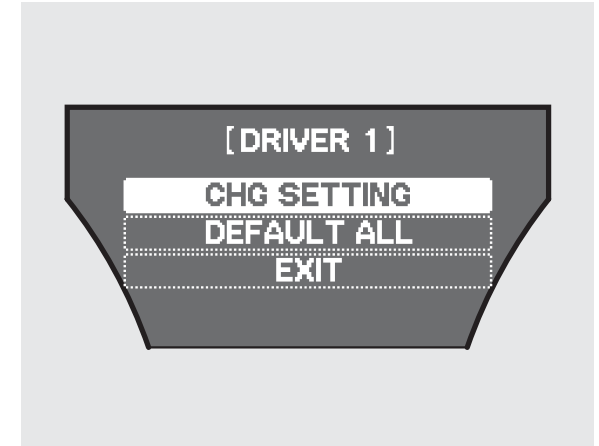

If you want the settings as they were when the vehicle left the factory, select DEFAULT ALL, as described on page 93.

If you want to change any vehicle control settings, select CHG SETTING, then press the SEL/RESET button.

Refer to the table on the following pages about the settings you want to customize.

Multi-Information Display

Group Setup	Menu Item	Description	Setting Option		Page
ACC SETUP (P. 96)	PRE-RUNNING CAR DETECT BEEP	Causes the system to beep when a vehicle ahead of you gets too close.	ON* ¹		97
			OFF		
	ACC DISPLAY SPEED UNIT	Changes the ACC display speed unit.	mph* ²	previous setting	98
			km/h* ³		
METER SETUP (P. 99)	LANGUAGE SELECTION	Changes the language used in the display.	ENGLISH* ¹		100
			FRENCH		
			SPANISH		
	ADJUST OUTSIDE TEMP. DISPLAY	Changes the outside temperature reading above or below its current reading.	- 5°F ~ ±0°F* ² ~ 5°F		101
			- 3°C ~ ±0°C* ³ ~ 3°C		
	TRIP A & AVG. FUEL RESET with REFUEL	Causes trip meter A and the average fuel economy to reset when you refuel.	ON		102
			OFF* ¹		
ADJUST ALARM VOLUME	Changes the indicator alarm volumes into three levels.	HIGH		103	
		MID* ¹			
		LOW			
ELAPSED TIME RESET	Resets the elapsed time of your current trip.	MANUAL ONLY		104	
		IGN OFF* ¹	TRIP B		
		TRIP A			
AUTO INTERIOR ILLUMINATION	Changes the interior light sensitivity to your liking.	MAX	LOW	105	
		HIGH	MIN		
		MID* ¹	OFF		
POSITION SETUP (P. 107)	MEMORY POSITION LINK	Changes the driver's seat, the steering wheel, and the outside mirror positions to a stored setting.	ON* ¹		108
			OFF		
	AUTO TILT & TELESCOPE STEERING WHEEL	Moves the steering wheel fully in and up when the key is removed.	ON* ¹		109
			OFF		

* 1: Default setting

* 2: Default setting for U.S. models

* 3: Default setting for Canadian models

CONTINUED

Multi-Information Display

Group Setup	Menu Item	Description	Setting Option		Page
LIGHTING SETUP (P. 110)	INTERIOR LIGHT DIMMING TIME	Changes how long (in seconds) the interior lights stay on after you close the doors and the tailgate.	60 sec	15 sec	111
			30 sec*		
	HEADLIGHT AUTO OFF TIMER	Changes how long (in seconds) the exterior lights stay on after you close the driver's door.	60 sec		112
			30 sec	0 sec	
			15 sec*		
	AUTO LIGHT SENSITIVITY	Changes the timing of when the headlights come on. The headlight switch needs to be in the AUTO position.	MAX	LOW	113
HIGH			MIN		
MID*					
DOOR/WINDOW SETUP (P. 115)	AUTO DOOR LOCK	Changes the setting of when to automatically lock the doors.	SHIFT FROM P		116
			WITH VEH SPD*		
			OFF		
	AUTO DOOR UNLOCK	Changes the setting of when to automatically unlock the driver's/all the doors.	SHIFT TO P *	DRIVER DOOR/ALL DOORS	117
			IGN OFF		
			OFF		
	KEY AND REMOTE UNLOCK MODE	Changes which doors unlock with the remote transmitter on a first push.	DRIVER DOOR*		119
			ALL DOORS		
	KEYLESS LOCK ACKNOWLEDGMENT	The exterior lights flash each time you press the LOCK or UNLOCK button. A beeper will also sound when you press the LOCK button twice.	ON*		120
			OFF		
	SECURITY RELOCK TIMER	Changes how long it takes (in seconds) for the doors to relock and the security system to set after you unlock but do not open the door.	90 sec		121
			60 sec		
30 sec*					
WIPER SETUP (P. 123)	WIPER ACTION	INTERMITTENT		123	
		WITH VEH SPD*			
DEFAULT ALL (P. 93)		Set/Cancel all the customized settings as default.		93	
		CANCEL			

*: Default setting

DEFAULT ALL

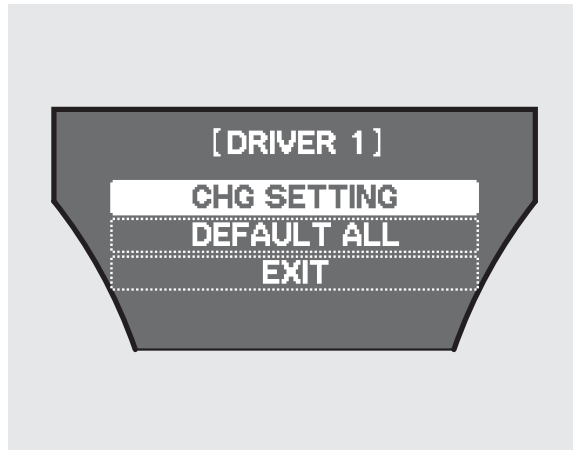

If you want to set the default settings, press the INFO (▲/▼) button to select DEFAULT ALL, then press the SEL/RESET button.

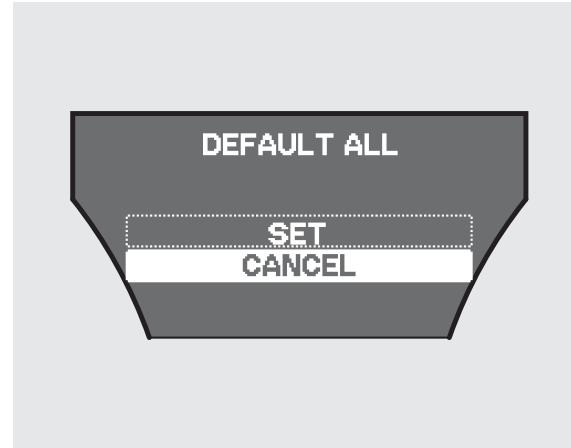

To set the default settings, press the INFO (▲/▼) button to select SET then press the SEL/RESET button.

If you want to cancel DEFAULT ALL, select CANCEL, then press the SEL/RESET button. The screen goes back to the previous display.

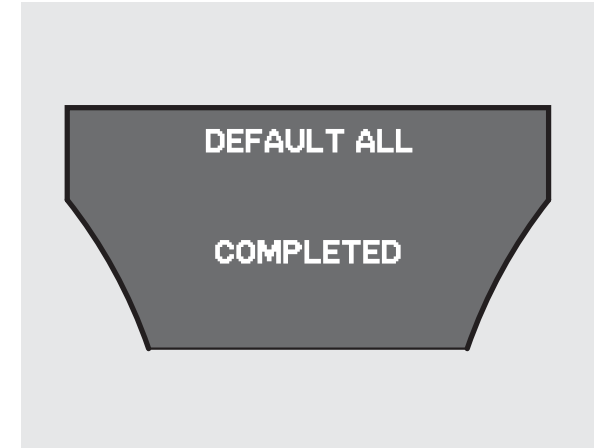

When DEFAULT ALL is set, you will see the above display for several seconds, then the screen returns to CUSTOMIZE ENTRY.

If the setting is not successfully completed, "FAILED" is shown for several seconds, and then the screen goes back to the normal message mode. Repeat the same procedure to select DEFAULT ALL.

CONTINUED

Multi-Information Display

Customize Settings

You can customize some of the vehicle control settings to your preference. Here are the settings you can customize:

- ADAPTIVE CRUISE CONTROL SETUP
- METER SETUP
- POSITION SETUP
- LIGHTING SETUP
- DOOR/WINDOW SETUP
- WIPER SETUP

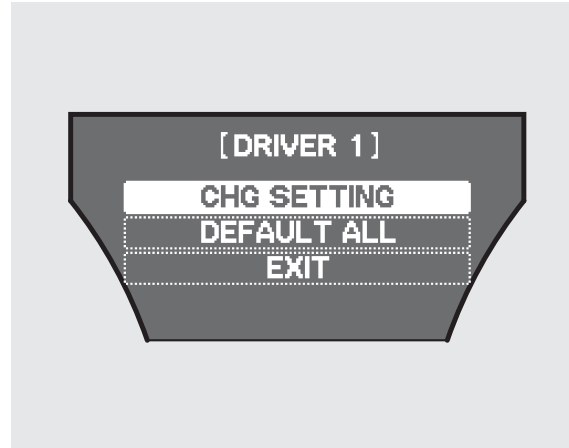

When you want to change the vehicle control settings, press the INFO (▲/▼) button to select CHG SETTING, then press the SEL/RESET button.

Each time you press the INFO (▲/▼) button, the screen changes as shown on the next page. Press the INFO (▲/▼) button, until you see the setup you want to customize, then press the SEL/RESET button to enter your selection.

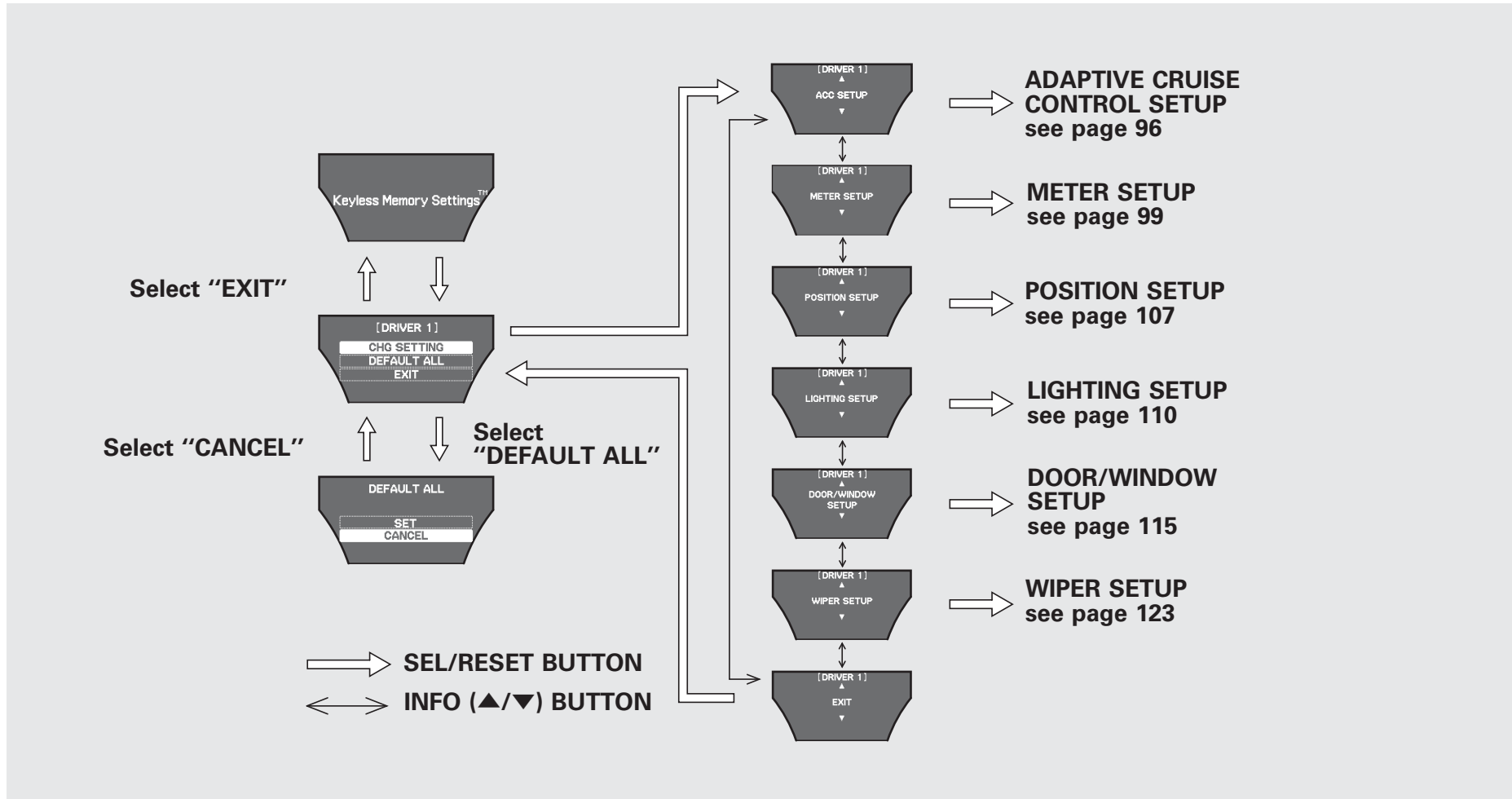

CONTINUED

Multi-Information Display

Adaptive Cruise Control Setup

If equipped

There are two custom settings for adaptive cruise control (ACC):

- PRE-RUNNING CAR DETECT BEEP
- ACC DISPLAY SPEED UNIT

To enter customize mode, press the SEL/RESET button while “ACC SETUP” is displayed.

Each time you press the INFO (▲/▼) button, the screen changes as shown in the illustration. Press the INFO (▲/▼) button until you see the setting you want to customize, then press the SEL/RESET button to enter your selection.

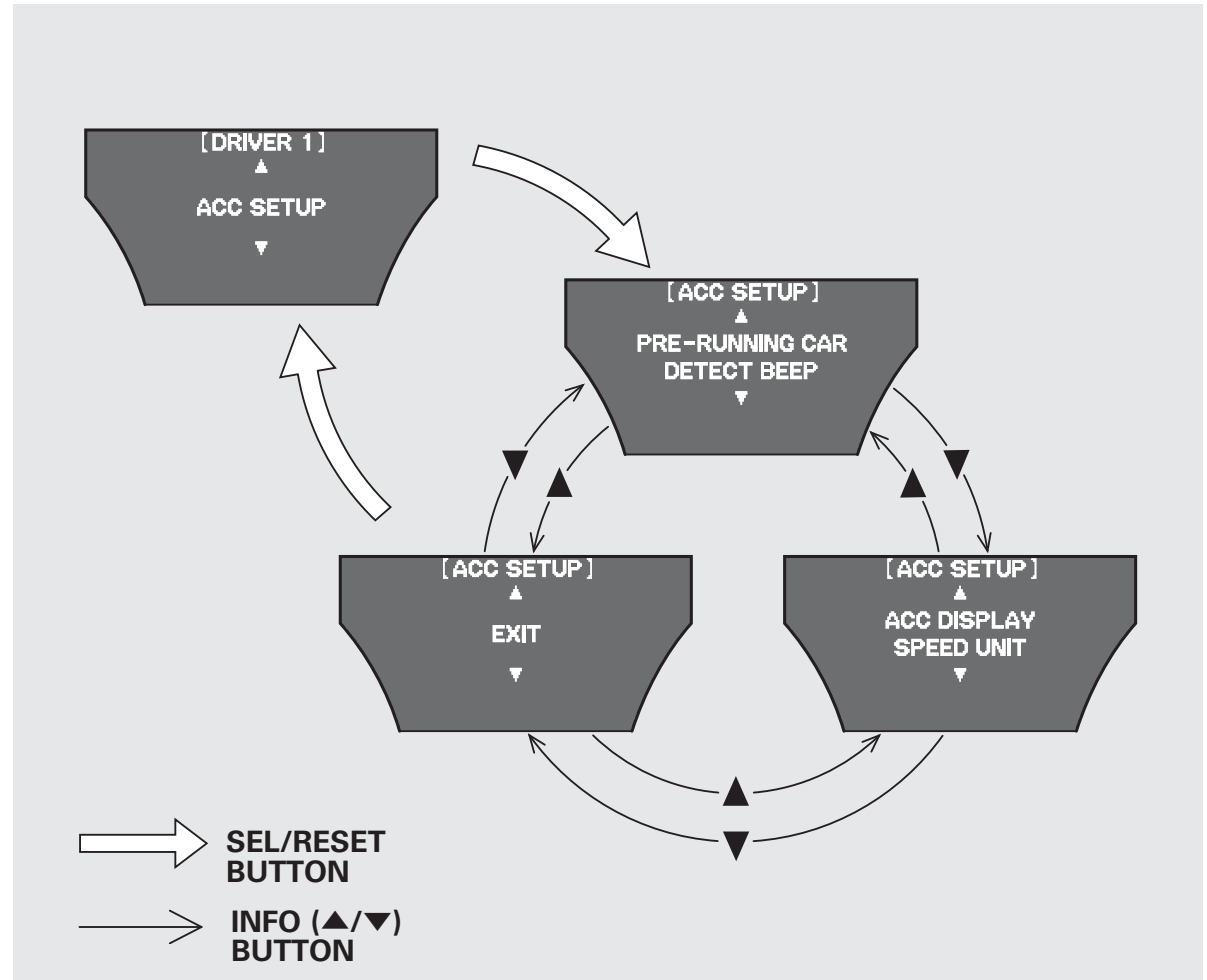

Pre-Running Car Detect Beep

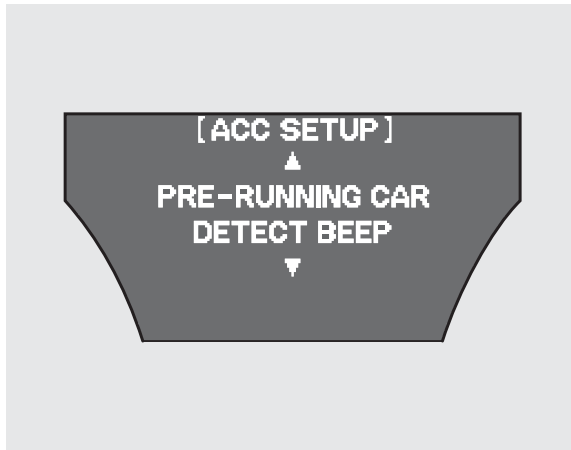

When PRE-RUNNING CAR DETECT BEEP is set to ON, one beep sounds when the ACC detects a vehicle in front of you. A beep also sounds when that vehicle passes out of the range of your vehicle's radar sensor.

Select this item from “ACC SETUP” by pressing the INFO (▲/▼) button repeatedly until “PRE-RUNNING CAR DETECT BEEP” is displayed.

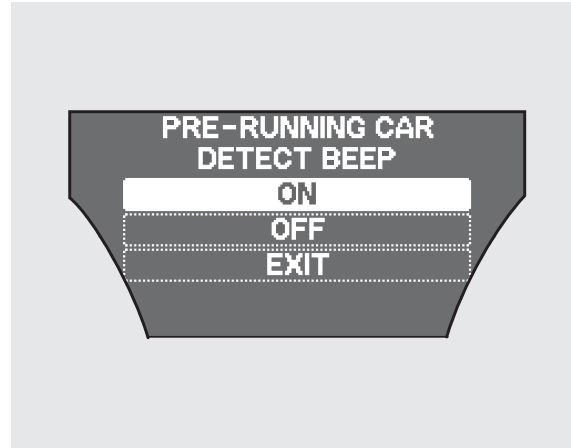

Press the SEL/RESET button to display the selections. Select ON or OFF by pressing the INFO (▲/▼) button, then press the SEL/RESET button to enter your selection.

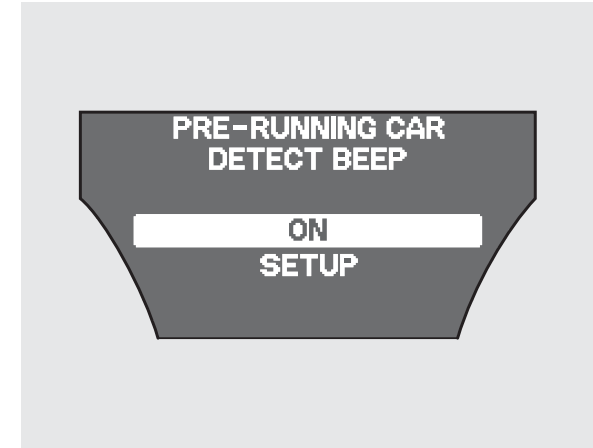

When your selection is successfully completed, the display changes as shown above, and then returns to the customize item screen.

If the “SETTING INCOMPLETE” message appears, return to “PRE-RUNNING CAR DETECT BEEP” and repeat the procedure again.

CONTINUED

Multi-Information Display

Adaptive Cruise Control Display Speed Unit

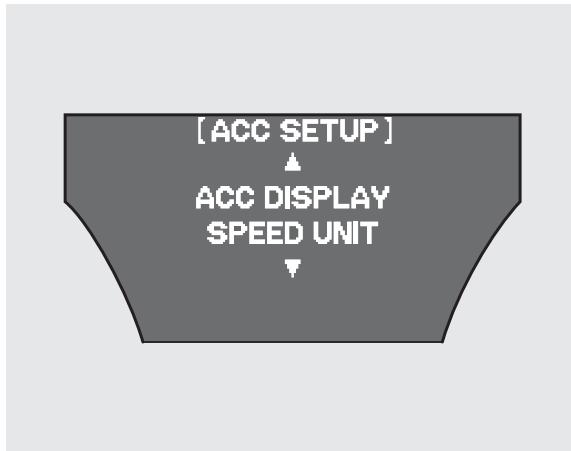

To change the unit of measurement from mph to km/h, follow these instructions:

Select this item from "ACC SETUP" by pressing the INFO (▲/▼) button repeatedly until "ACC DISPLAY SPEED UNIT" is displayed.

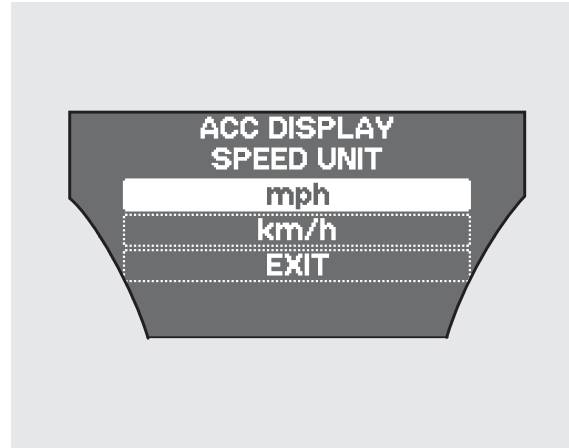

Press the SEL/RESET button to display the selections. The highlighted unit, mph or km/h, is the current setting. To change the setting, press the INFO (▲/▼) button until the unit you want is highlighted, then press the SEL/RESET button.

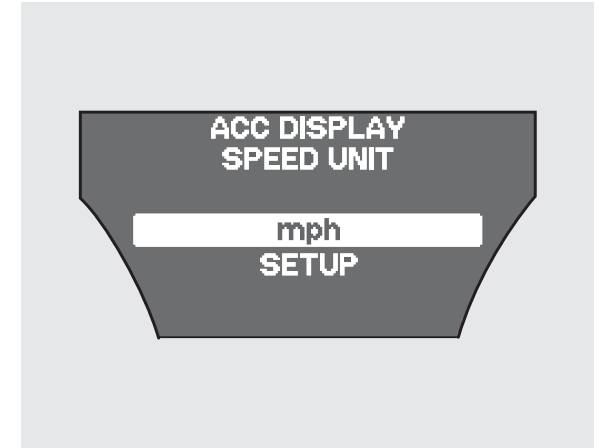

When your selection is successfully completed, the display changes as shown above, and then returns to the customize item screen.

If the "SETTING INCOMPLETE" message appears, return to "ACC DISPLAY SPEED UNIT" and repeat the procedure again.

Meter Setup

Here are the six custom settings for the meter setup:

- LANGUAGE SELECTION
- ADJUST OUTSIDE TEMP. DISPLAY
- TRIP A & AVG. FUEL RESET with REFUEL
- ADJUST ALARM VOLUME
- ELAPSED TIME RESET
- AUTO INTERIOR ILLUMINATION

While METER SETUP is shown, press the SEL/RESET button to enter the customize mode.

Each time you press the INFO (▲/▼) button, the screen changes as shown in the illustration. Press the INFO (▲/▼) button until you see the setting you want to customize, then press the SEL/RESET button to enter your selection.

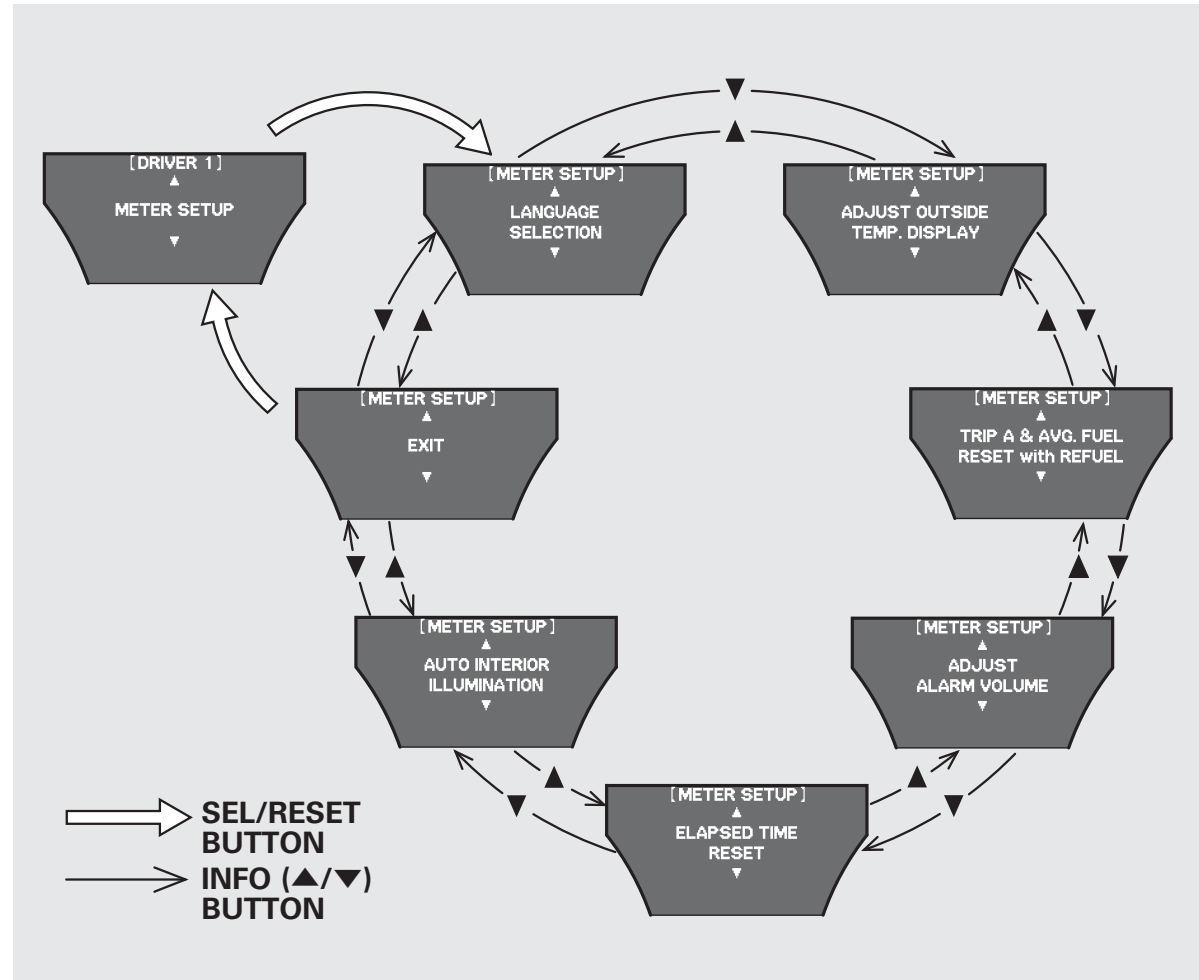

CONTINUED

Multi-Information Display

Language Selection

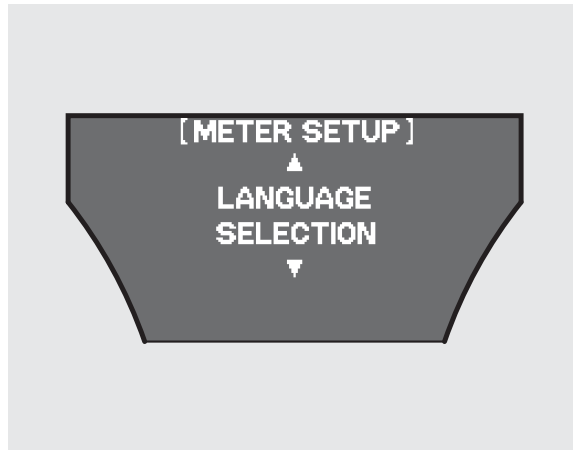

There are three language selections you can make: English, French, and Spanish. To choose the language you want, follow these instructions:

You can choose this customizable item from "METER SETUP" by pressing the INFO (▲/▼) button repeatedly.

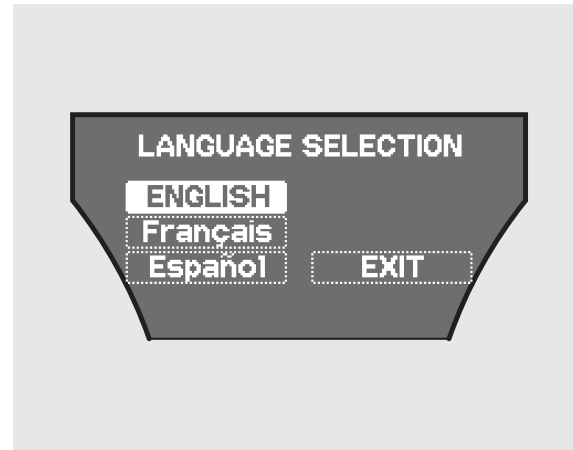

Press the SEL/RESET button to see the selections.

Select the desired language by pressing the INFO (▲/▼) button, then enter your selection by pressing the SEL/RESET button.

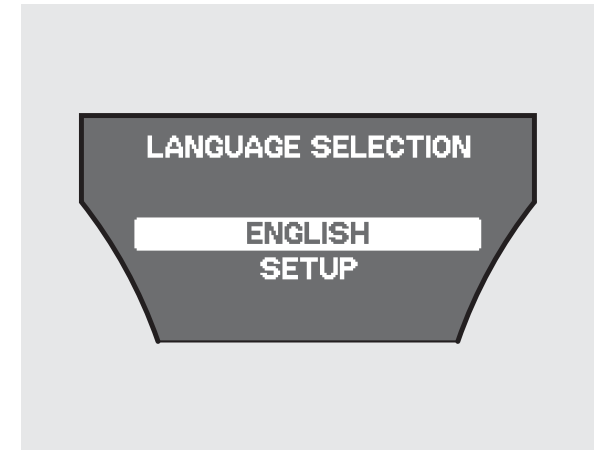

When your selection is successfully completed, the display changes as shown above, and then goes back to the customize item screen.

If the "SETTING INCOMPLETE" message appears, go back to "LANGUAGE SELECTION" and repeat the procedure again.

Adjust Outside Temp. Display

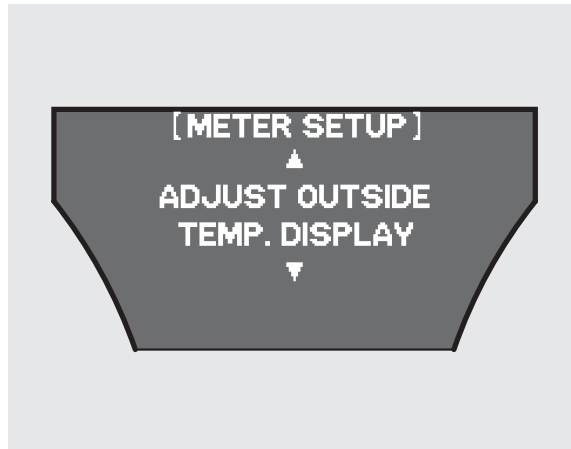

If you sometimes find that the temperature reading is a few degrees above or below the actual temperature, you can adjust it by following these instructions:

You can choose this customizable item from "METER SETUP" by pressing the INFO (▲/▼) button repeatedly.

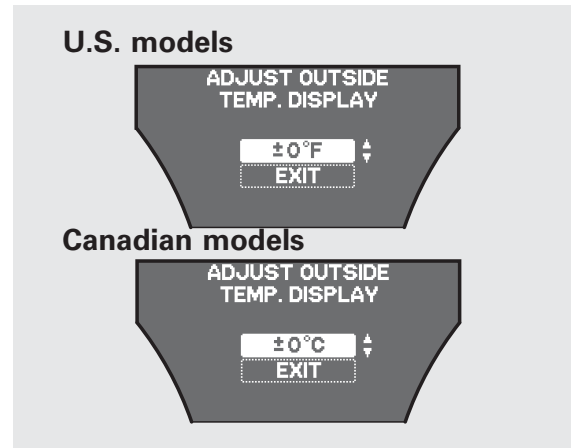

Adjust the outside temperature value by pressing the INFO (▲/▼) button repeatedly. Press the SEL/RESET button to set the desired value.

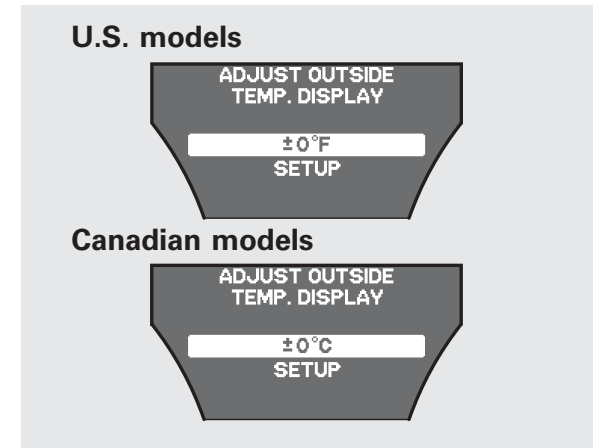

When your selection is successfully completed, the display changes as shown above, and then goes back to the customize item screen.

If the "SETTING INCOMPLETE" message appears, go back to "ADJUST OUTSIDE TEMP. DISPLAY" and repeat the procedure again.

CONTINUED

Multi-Information Display

Trip A & Avg. Fuel Reset With Refuel

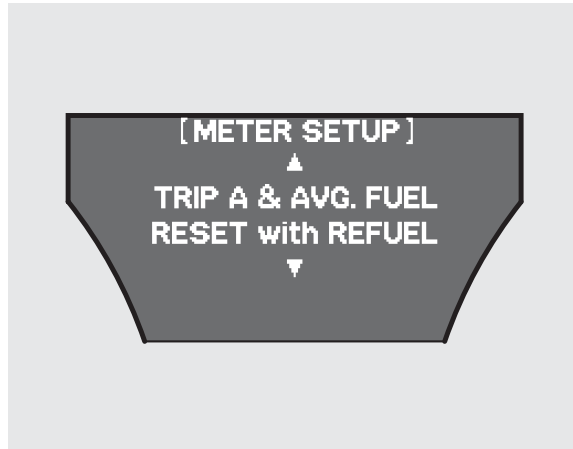

To cause Trip A and AVG. FUEL to reset every time you refuel your vehicle, follow these instructions:

You can choose this customizable item from “METER SETUP” by pressing the INFO (▲/▼) button repeatedly.

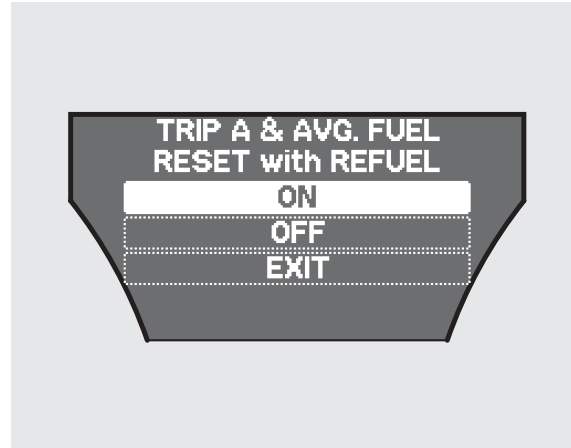

Press the SEL/RESET button to see the selections.

Select ON or OFF by pressing the INFO (▲/▼) button, then enter your selection by pressing the SEL/RESET button.

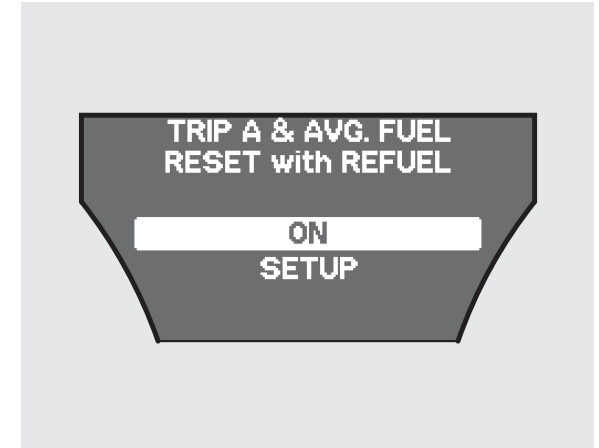

When your selection is successfully completed, the display changes as shown above, and then goes back to the customize item screen.

If the “SETTING INCOMPLETE” message appears, go back to “TRIP A & AVG. FUEL RESET with REFUEL” and repeat the procedure again.

Adjust Alarm Volume

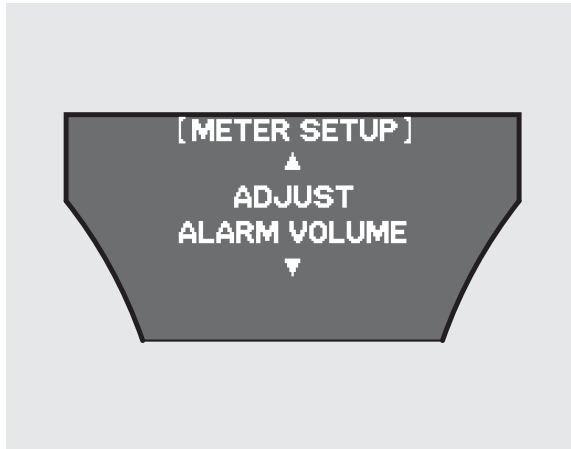

Select the warning alarm volume from three levels.

You can choose this customizable item from “METER SETUP” by pressing the INFO (▲/▼) button repeatedly.

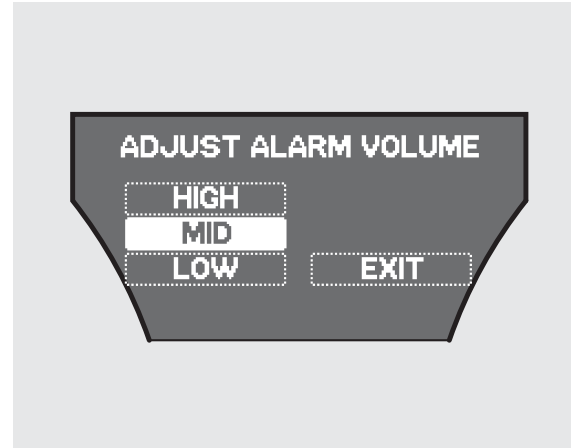

Press the SEL/RESET button to see the selections.

Select the desired level by pressing the INFO (▲/▼) button, then enter your selection by pressing the SEL/RESET button.

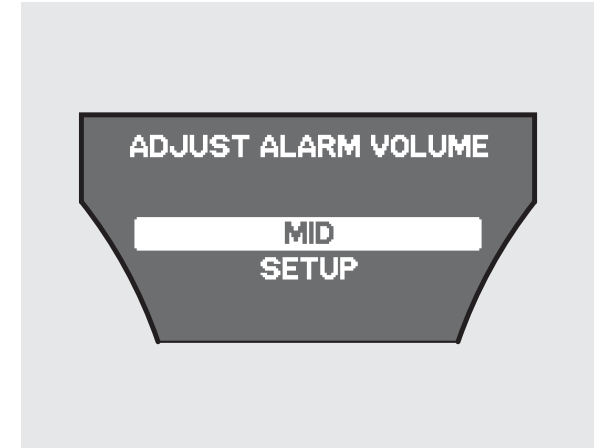

When your selection is successfully completed, the display changes as shown above, and then goes back to the customize item screen.

If the “SETTING INCOMPLETE” message appears, go back to “ADJUST ALARM VOLUME” and repeat the procedure again.

CONTINUED

Multi-Information Display

Elapsed Time Reset

There are four elapsed time reset choices you can make:

MANUAL ONLY – You can reset the elapsed time, when Trip Computer's Elapsed Time is displayed (see page 85).

IGN OFF – The elapsed time is reset when you turn the ignition switch to the LOCK (0) position.

TRIP A – The elapsed time is reset when the Trip A is reset.

TRIP B – The elapsed time is reset when the Trip B is reset.

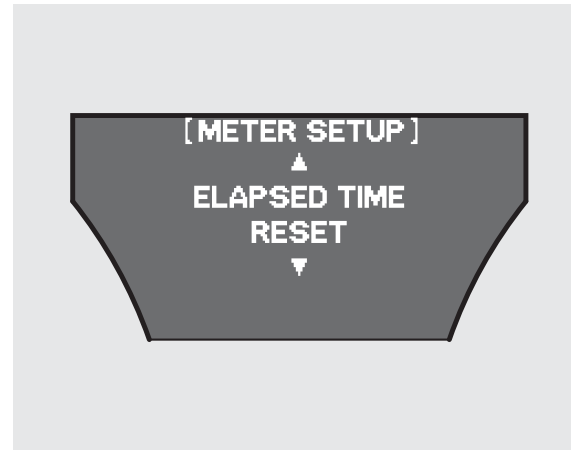

You can choose this customizable item from "METER SETUP" by pressing the INFO (▲/▼) button repeatedly.

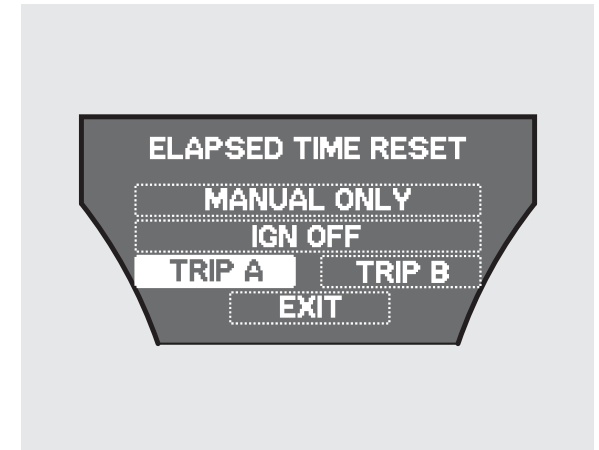

Press the SEL/RESET button to see the selections.

Select the desired setting by pressing the INFO (▲/▼) button, then enter your selection by pressing the SEL/RESET button.

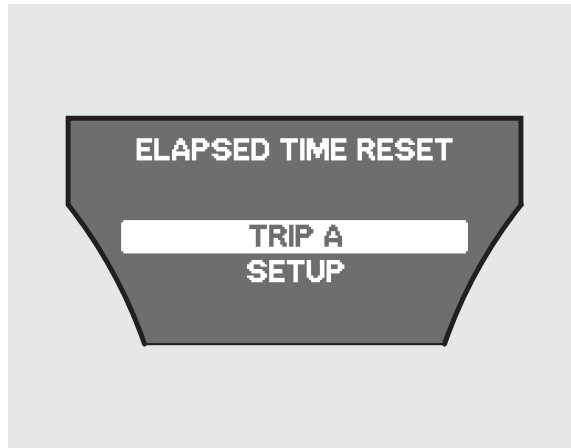

When your selection is successfully completed, the display changes as shown above, and then goes back to the customize item screen.

If the “SETTING INCOMPLETE” message appears, go back to “ELAPSED TIME RESET” and repeat the procedure again.

Auto Interior Illumination

While the headlight switch is turned on, the interior lights gradually dim, as the outside light level gets low. You can customize at which outside light level the lights start to dim.

There are MAX, HIGH, MID, LOW and MIN levels and OFF for the auto interior illumination settings.

If you want the illuminations to start dimming as early as possible, select MAX. For illuminations to start dimming as late as possible, select MIN. Choose HIGH, MID, or LOW for levels in between.

To disable the auto interior illumination function, select OFF.

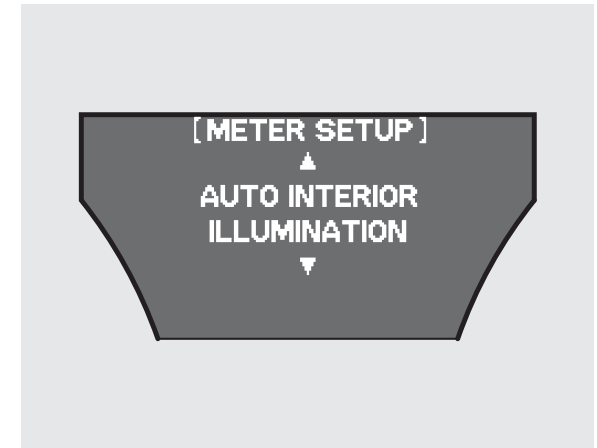

You can choose this customizable item from “METER SETUP” by pressing the INFO (▲/▼) button repeatedly.

CONTINUED

Multi-Information Display

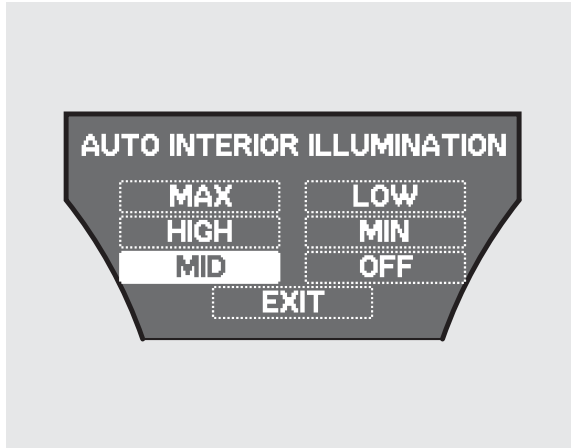

Press the SEL/RESET button to see the selections.

Select the desired setting by pressing the INFO (▲/▼) button, then enter your selection by pressing the SEL/RESET button.

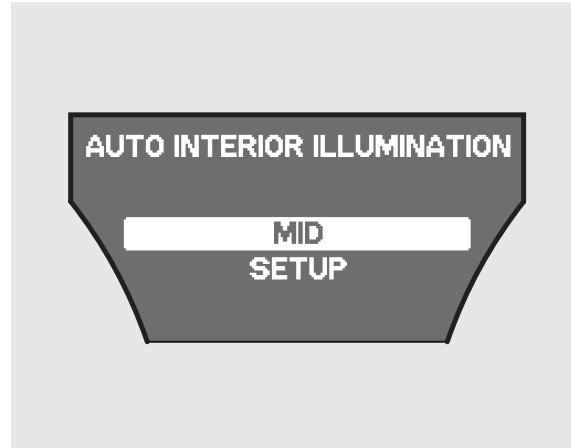

When your selection is successfully completed, the display changes as shown above, and then goes back to the customize item screen.

If the "SETTING INCOMPLETE" message appears, go back to "AUTO INTERIOR ILLUMINATION" and repeat the procedure again.

Position Setup

Here are the two custom settings for the position setup:

- MEMORY POSITION LINK
- AUTO TILT & TELESCOPE STEERING WHEEL

While “POSITION SETUP” is shown, press the SEL/RESET button to enter the customize mode.

Each time you press the INFO (▲/▼) button, the screen changes as shown in the illustration. Press the INFO (▲/▼) button until you see the setting you want to customize, then press the SEL/RESET button to enter your selection.

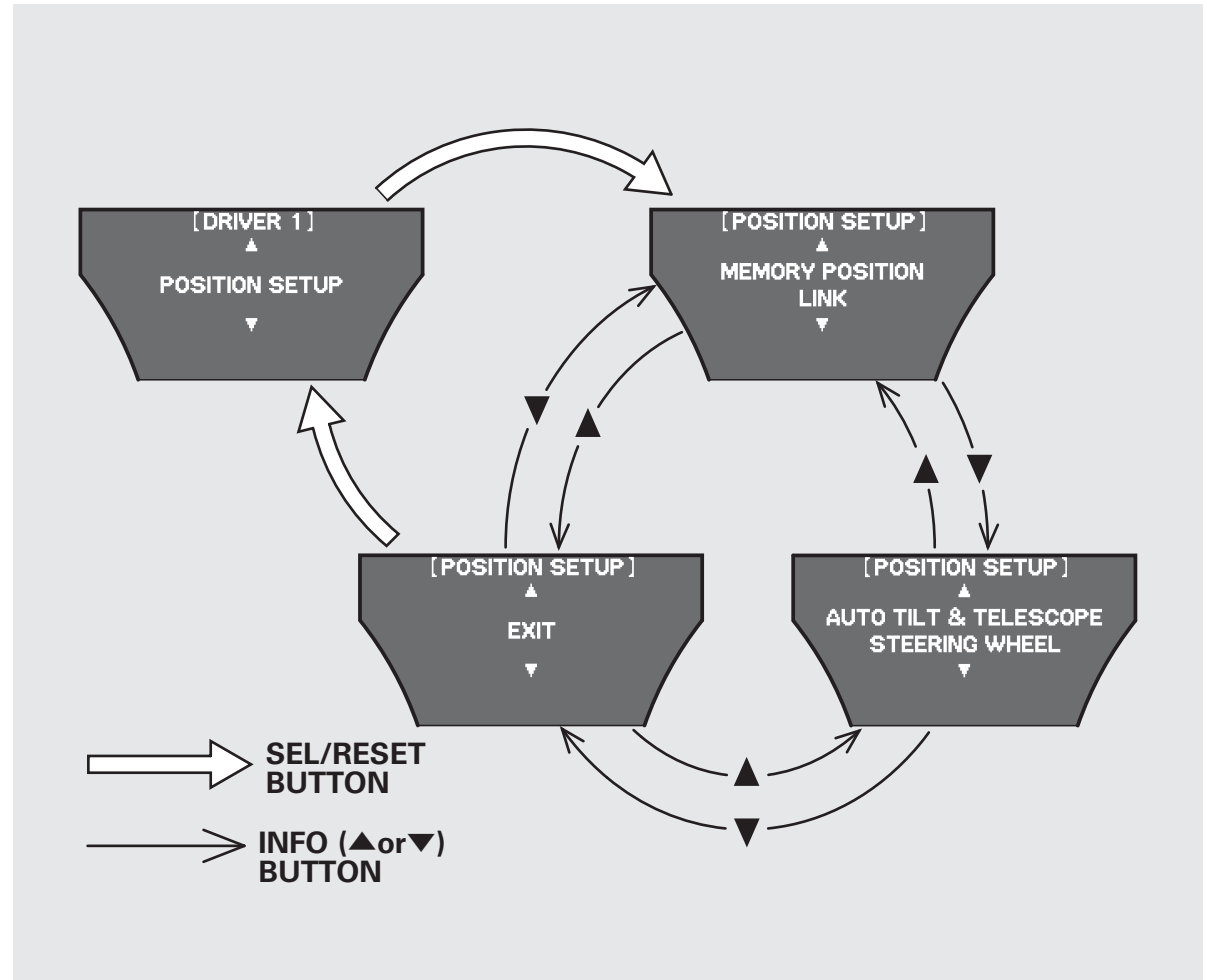

CONTINUED

Multi-Information Display

Memory Position Link

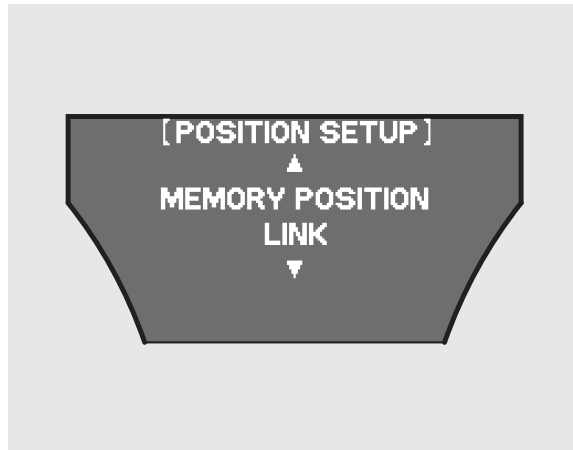

If “MEMORY POSITION LINK” is set to “ON,” the driver's seat, the steering wheel, and outside mirror positions move to the position stored in the memory when you open the driver's door, using the remote transmitter.

You can choose this customizable item from “POSITION SETUP” by pressing the INFO (▲/▼) button repeatedly.

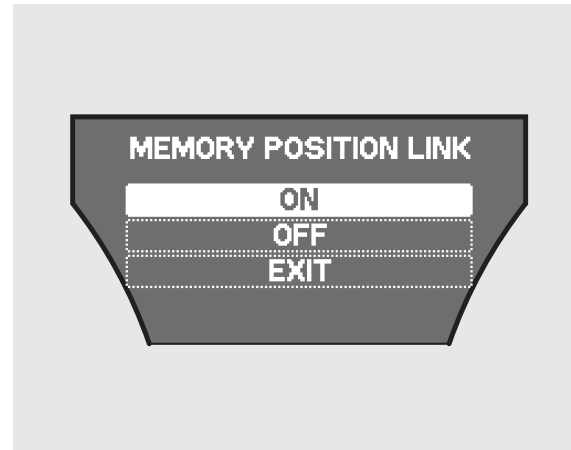

Press the SEL/RESET button to see the selections.

Select ON or OFF by pressing the INFO (▲/▼) button, then enter your selection by pressing the SEL/RESET button.

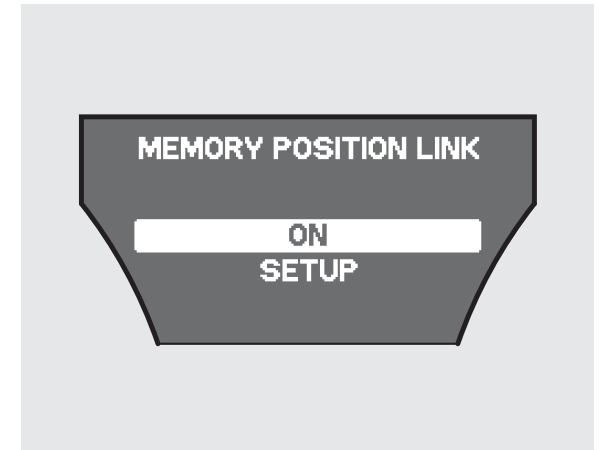

When your selection is successfully completed, the display changes as shown above, and then goes back to the customize item screen.

If the “SETTING INCOMPLETE” message appears, go back to “MEMORY POSITION LINK” and repeat the procedure again.

Auto Tilt & Telescope Steering Wheel

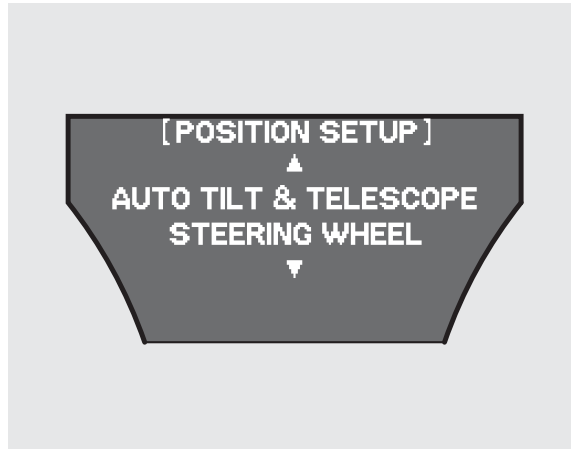

When “AUTO TILT & TELESCOPE STEERING WHEEL” is set to “ON,” the steering wheel automatically moves fully in and up when you turn the ignition switch to the LOCK (0) position and remove the key.

You can choose this customizable item from “POSITION SETUP” by pressing the INFO (▲/▼) button repeatedly.

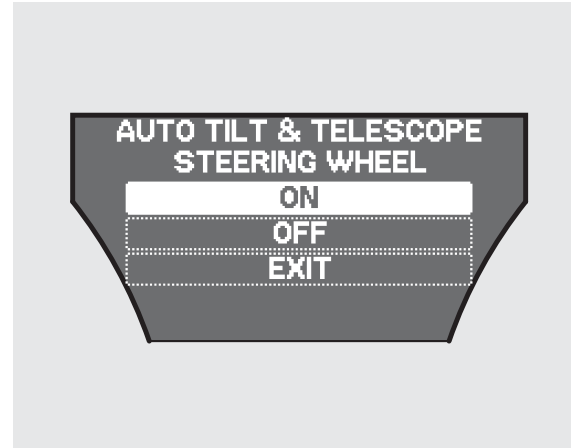

Press the SEL/RESET button to see the selections.

Select ON or OFF by pressing the INFO (▲/▼) button, then enter your selection by pressing the SEL/RESET button.

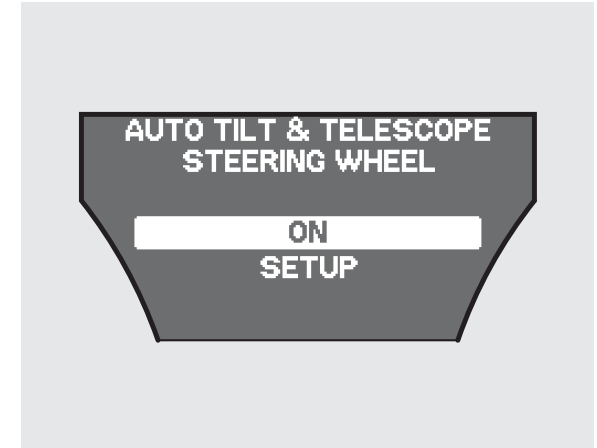

When your selection is successfully completed, the display changes as shown above, and then goes back to the customize item screen.

If the “SETTING INCOMPLETE” message appears, go back to “AUTO TILT & TELESCOPE STEERING WHEEL” and repeat the procedure again.

CONTINUED

Multi-Information Display

Lighting Setup

Here are the three custom settings for the lighting setup:

- INTERIOR LIGHT DIMMING TIME
- HEADLIGHT AUTO OFF TIMER
- AUTO LIGHT SENSITIVITY

While “LIGHTING SETUP” is shown, press the SEL/RESET button to enter the customize mode.

Each time you press the INFO (▲/▼) button, the screen changes as shown in the illustration. Press the INFO (▲/▼) button until you see the setting you want to customize, then press the SEL/RESET button to enter your selection.

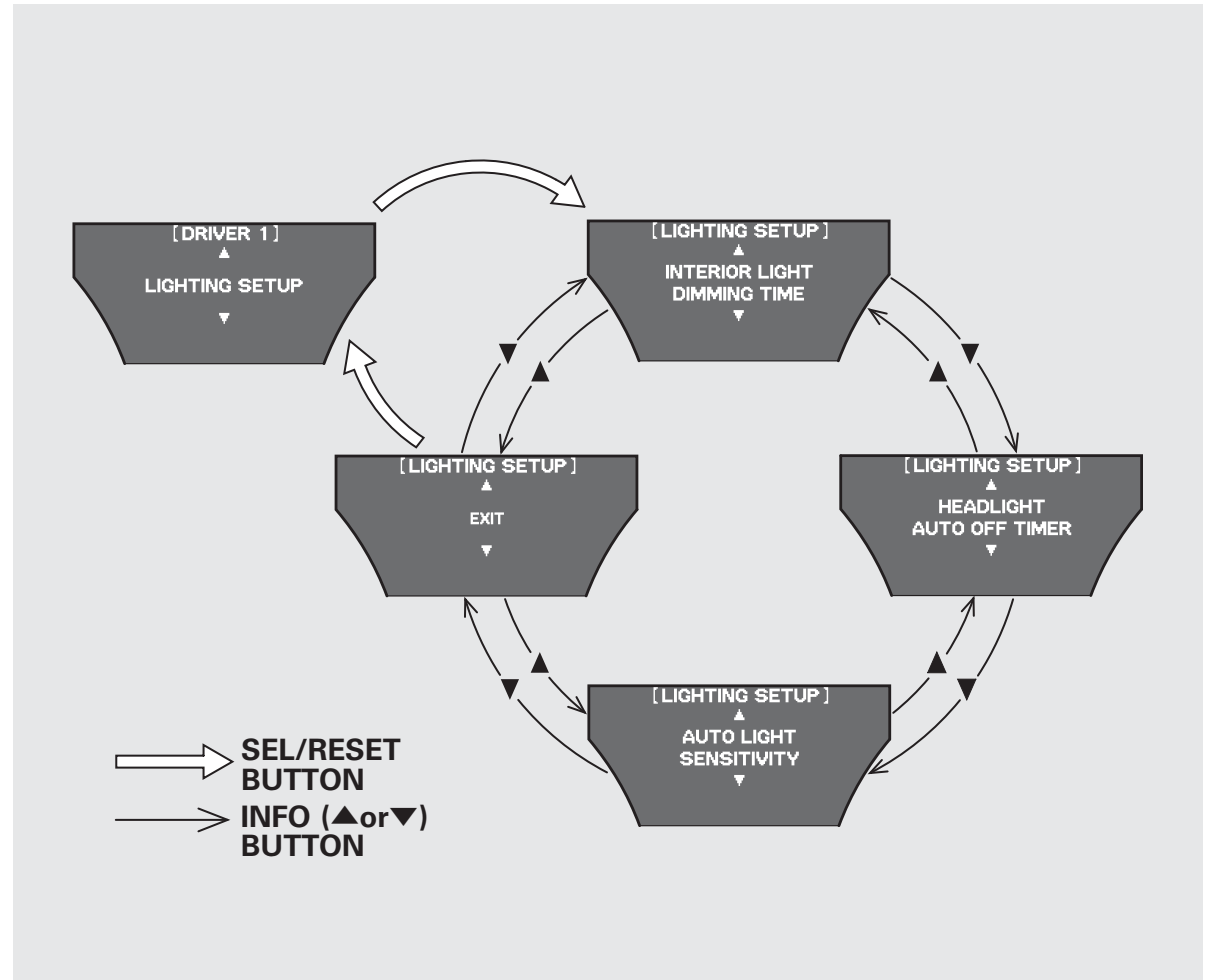

Interior Light Dimming Time

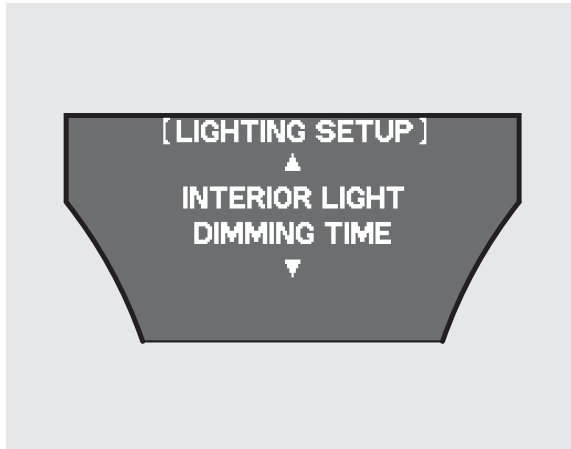

The interior lights fade out when you close all doors and tailgate. To change how long the lights stay on before they fade out, follow these instructions:

You can choose this customizable item from “LIGHTING SETUP” by pressing the INFO (▲/▼) button repeatedly.

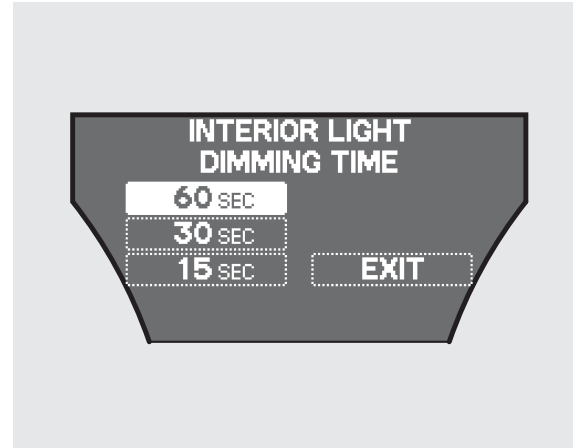

Press the SEL/RESET button to see the selections.

Select the desired setting by pressing the INFO (▲/▼) button, then enter your selection by pressing the SEL/RESET button.

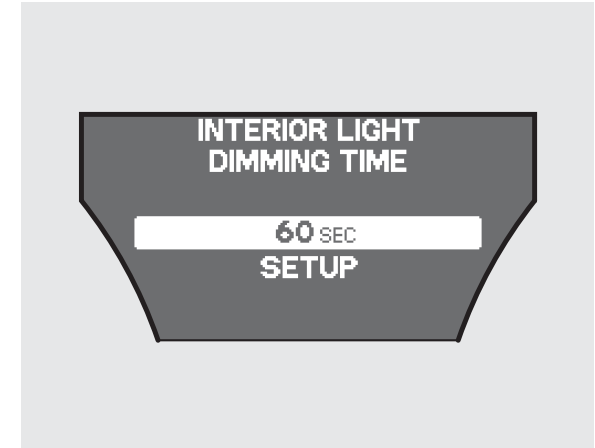

When your selection is successfully completed, the display changes as shown above, and then goes back to the customize item screen.

If the “SETTING INCOMPLETE” message appears, go back to “INTERIOR LIGHT DIMMING TIME” and repeat the procedure again.

CONTINUED

Multi-Information Display

Headlight Auto Off Timer

The headlights, parking lights, side marker lights, taillights, and license plate lights go off after the selected time when you remove the key from the ignition switch and close the driver's door. To change how long the lights stay on before they go off, follow these instructions:

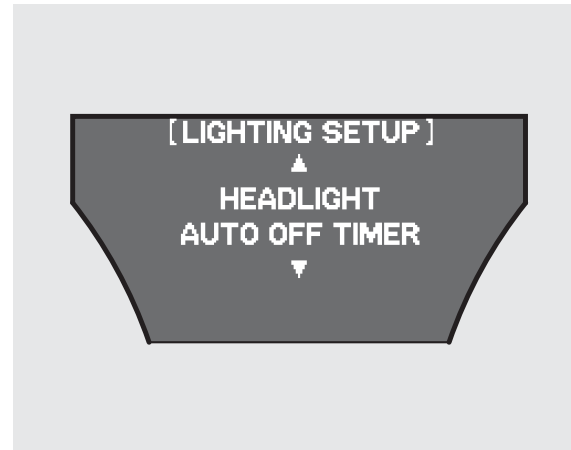

You can choose this customizable item from “LIGHTING SETUP” by pressing the INFO (▲/▼) button repeatedly.

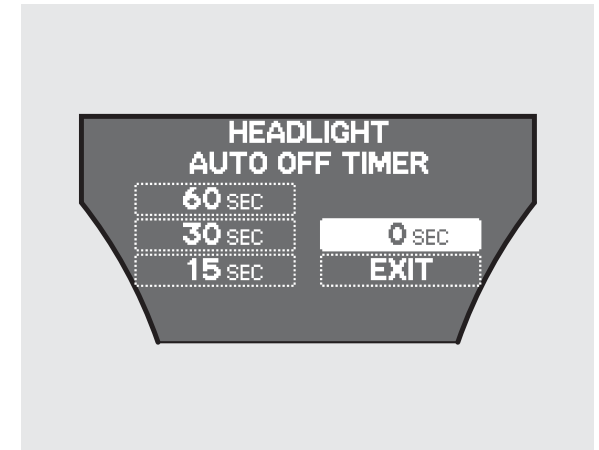

Press the SEL/RESET button to see the selections.

Select the desired setting by pressing the INFO (▲/▼) button, then enter your selection by pressing the SEL/RESET button.

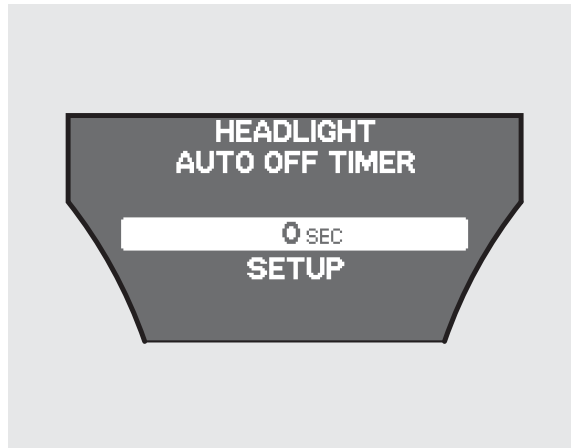

When your selection is successfully completed, the display changes as shown above, and then goes back to the customize item screen.

If the “SETTING INCOMPLETE” message appears, go back to “HEADLIGHT AUTO OFF TIMER” and repeat the procedure again.

Auto Light Sensitivity

The headlights automatically come on when the headlight switch is in the AUTO position and the ambient light reaches a changeable level. You can select the auto light sensitivity from the following five levels:

MAX –

The headlights come on when it is bright.

HIGH –

The headlights come on when it is somewhat bright.

MID –

The headlights come on when it is as bright as sunset or sunrise.

LOW –

The headlights come on when it is somewhat dark.

MIN –

The headlights come on when it is dark.

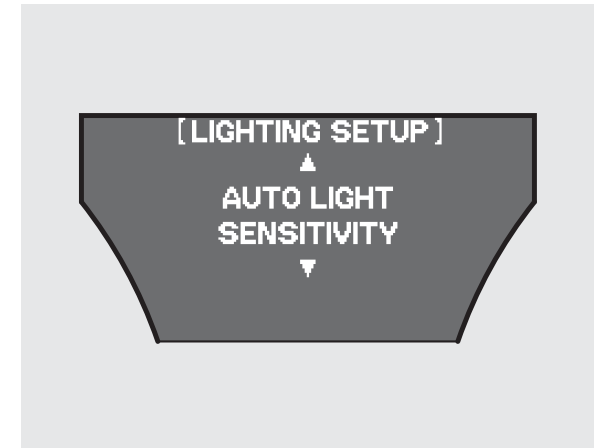

You can choose this customizable item from “LIGHTING SETUP” by pressing the INFO (▲/▼) button repeatedly.

CONTINUED

Multi-Information Display

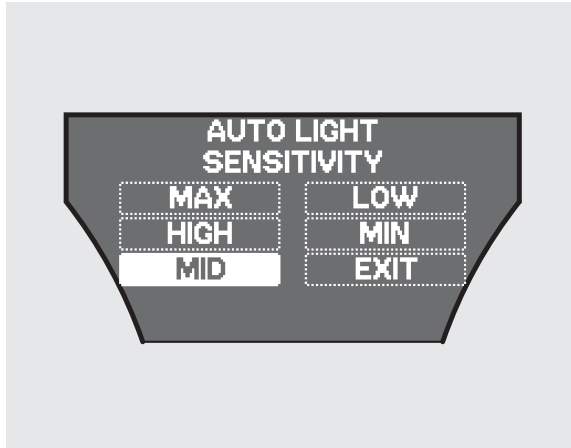

Press the SEL/RESET button to see the selections.

Select the desired setting by pressing the INFO (▲/▼) button, then enter your selection by pressing the SEL/RESET button.

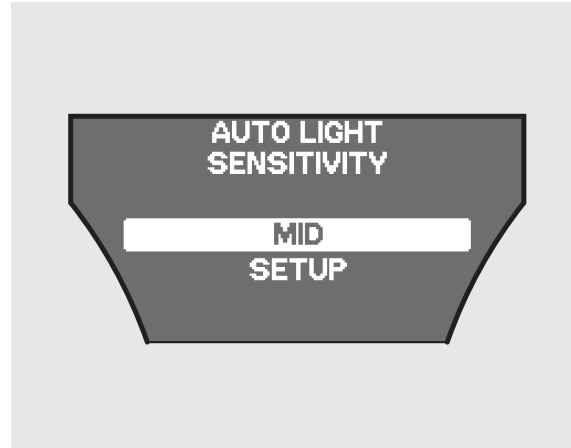

When your selection is successfully completed, the display changes as shown above, and then goes back to the customize item screen.

If the "SETTING INCOMPLETE" message appears, go back to "AUTO LIGHT SENSITIVITY" and repeat the procedure again.

Door/Window Setup

Here are the five custom settings for the door/window setup:

- AUTO DOOR LOCK
- AUTO DOOR UNLOCK
- KEY AND REMOTE UNLOCK MODE
- KEYLESS LOCK ACKNOWLEDGMENT
- SECURITY RELOCK TIMER

While “DOOR/WINDOW SETUP” is shown, press the SEL/RESET button to enter the customize mode.

Each time you press the INFO (▲/▼) button, the screen changes as shown in the illustration. Press the INFO (▲/▼) button until you see the setting you want to customize, then press the SEL/RESET button to enter your selection.

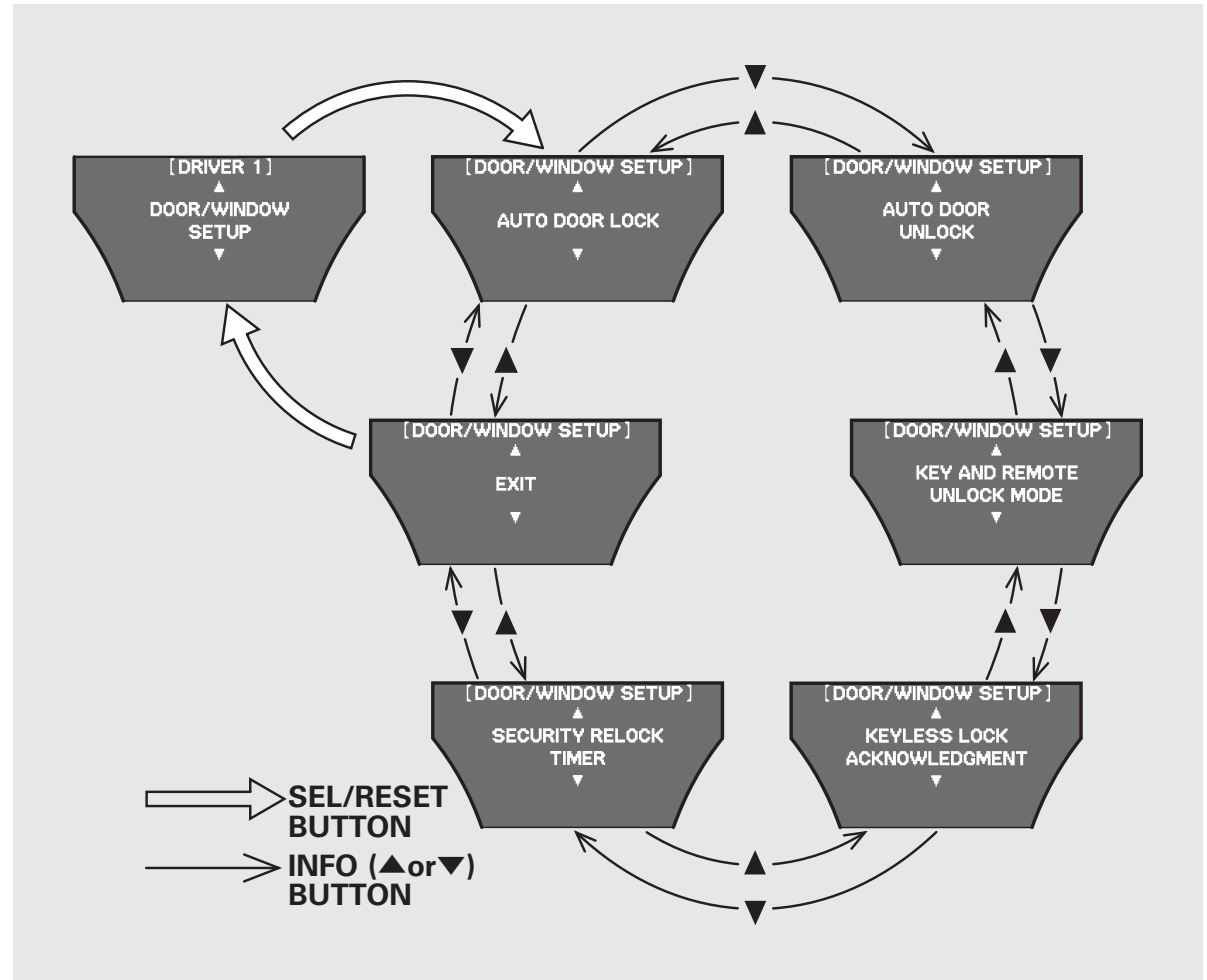

CONTINUED

Multi-Information Display

Auto Door Lock

There are three settings you can choose from:

SHIFT FROM P –

The doors lock whenever you move the shift lever out of Park.

WITH VEH SPD –

The doors lock when the vehicle speed reaches about 10 mph (about 16 km/h).

OFF –

The auto door lock is deactivated all the time.

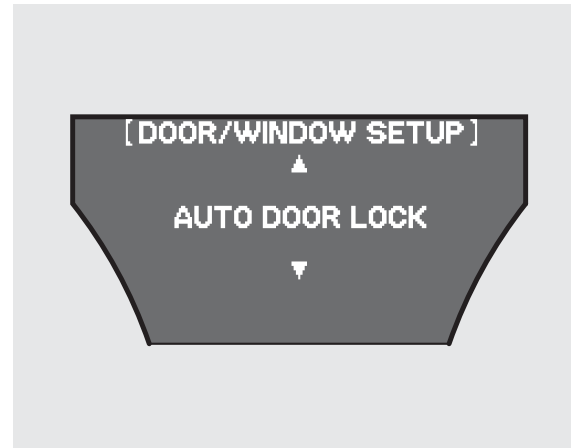

You can choose this customizable item from “DOOR/WINDOW SETUP” by pressing the INFO (▲/▼) button repeatedly.

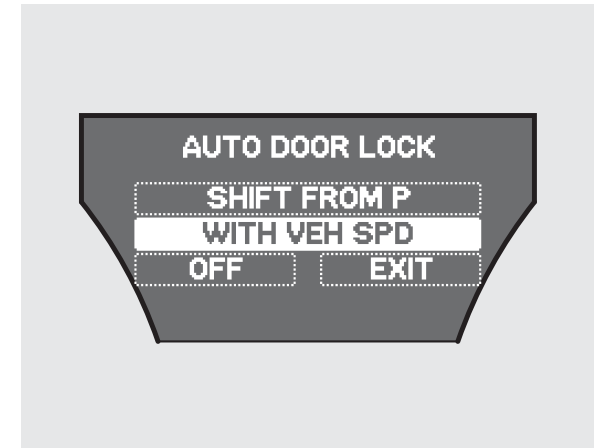

Press the SEL/RESET button to see the selections.

Select the desired setting by pressing the INFO (▲/▼) button, then enter your selection by pressing the SEL/RESET button.

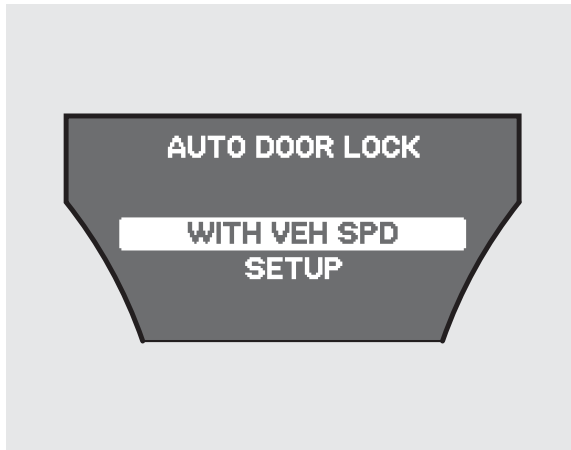

When your selection is successfully completed, the display changes as shown above, and then goes back to the customize item screen.

If the “SETTING INCOMPLETE” message appears, go back to “AUTO DOOR LOCK” and repeat the procedure again.

Auto Door Unlock

There are three settings you can choose from:

SHIFT TO P – The driver's door or all the doors, depending on the door lock mode setting (see page 116), unlock when you move the shift lever to Park with the brake pedal depressed.

IGN OFF – The driver's door or all the doors, depending on the door lock mode setting (see page 116), unlock when you turn the ignition switch to the LOCK (0) position.

OFF – The auto door unlock is deactivated all the time. This is the factory default setting.

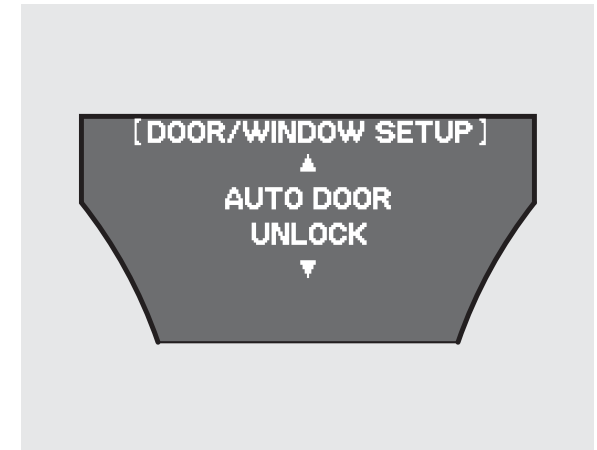

You can choose this customizable item from “DOOR/WINDOW SETUP” by pressing the INFO (▲/▼) button repeatedly.

CONTINUED

Multi-Information Display

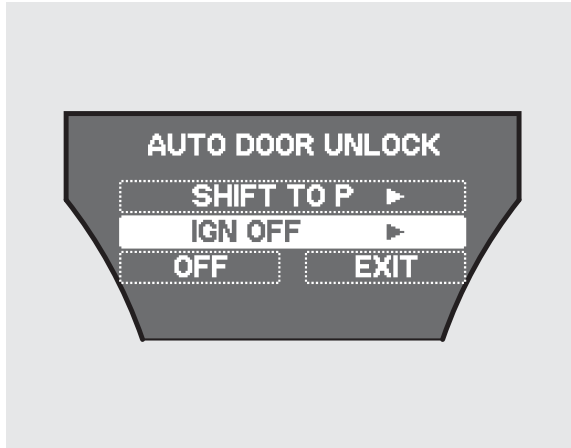

Press the SEL/RESET button to see the selections.

Select the desired setting by pressing the INFO (▲/▼) button, then enter your selection by pressing the SEL/RESET button.

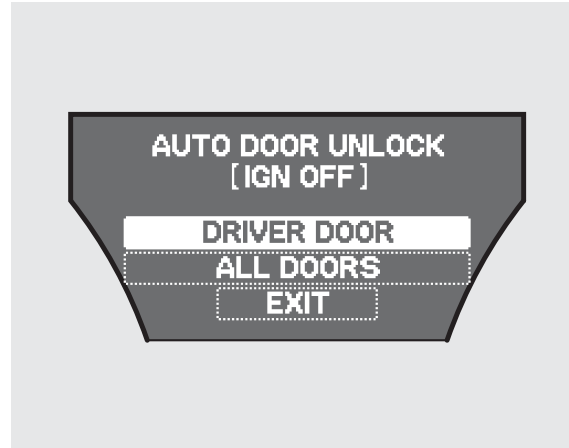

If you choose "SHIFT TO P" or "IGN OFF", you will see the above display.

Press the INFO (▲/▼) button to switch the door lock mode setting between the driver's door and all doors. Then, press the SEL/RESET button to enter your selection.

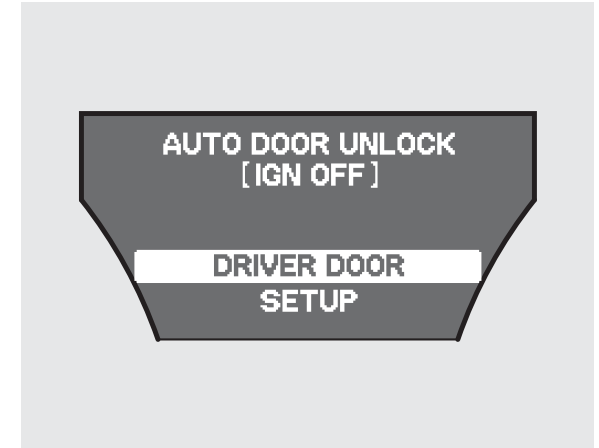

When your selection is successfully completed, the display changes as shown above, and then goes back to the customize item screen.

If the "SETTING INCOMPLETE" message appears, go back to "AUTO DOOR UNLOCK" and repeat the procedure again.

Key and Remote Unlock Mode

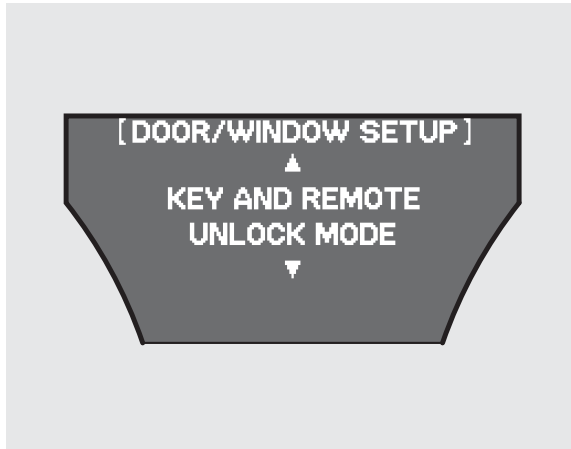

To select whether the driver's or all doors unlock when the remote transmitter or key is used, follow these instructions.

You can choose this customizable item from "DOOR/WINDOW SETUP" by pressing the INFO (▲/▼) button repeatedly.

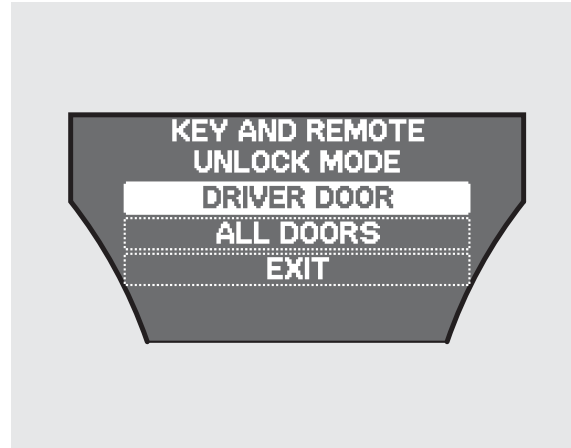

Press the SEL/RESET button to see the selections.

Select the desired setting by pressing the INFO (▲/▼) button, then enter your selection by pressing the SEL/RESET button.

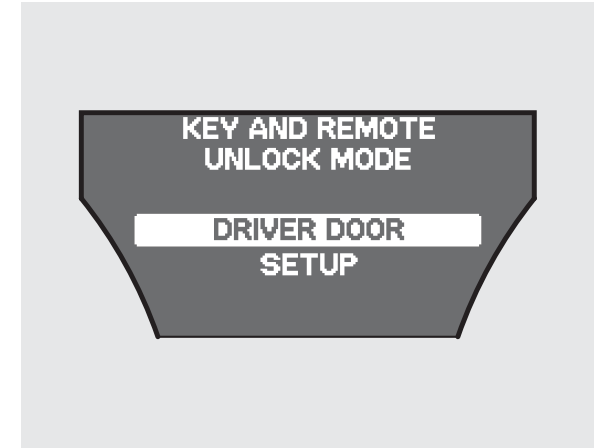

When your selection is successfully completed, the display changes as shown above, and then goes back to the customize item screen.

If the "SETTING INCOMPLETE" message appears, go back to "KEY AND REMOTE UNLOCK MODE" and repeat the procedure again.

CONTINUED

Multi-Information Display

Keyless Lock Acknowledgment

When you push the LOCK button on the remote transmitter, some exterior lights flash, and a beeper sounds when you push the LOCK button again within 5 seconds to verify that the doors and the tailgate are locked and the security system has set (see page 341). You can customize the exterior lights not to flash and the beeper not to sound.

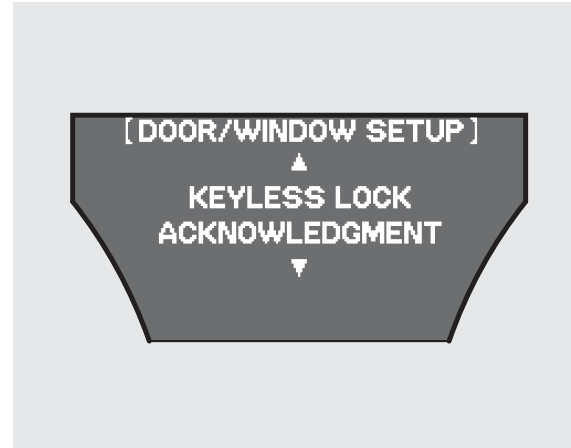

You can choose this customizable item from “DOOR/WINDOW SETUP” by pressing the INFO (▲/▼) button repeatedly.

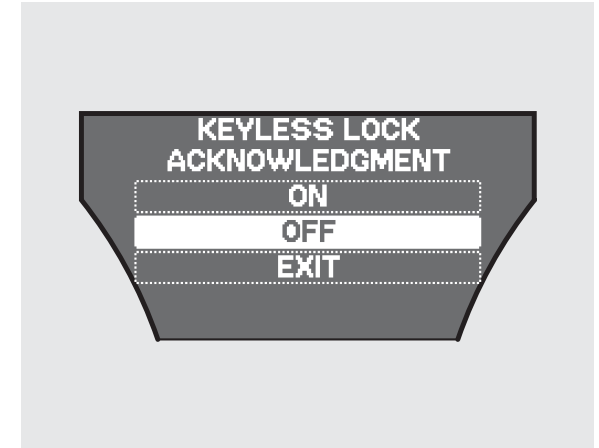

Press the SEL/RESET button to see the selections.

Select ON or OFF by pressing the INFO (▲/▼) button, then enter your selection by pressing the SEL/RESET button.

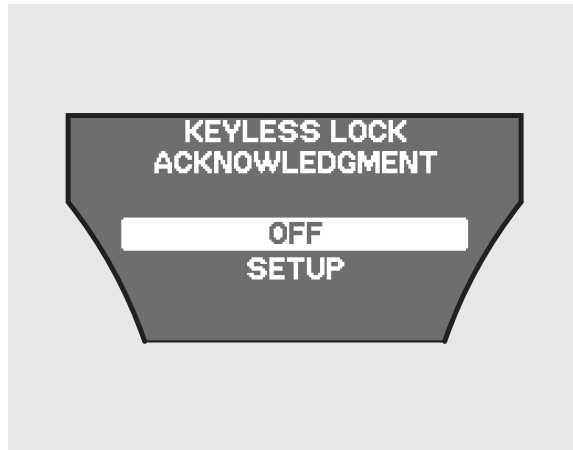

When your selection is successfully completed, the display changes as shown above, and then goes back to the customize item screen.

If the “SETTING INCOMPLETE” message appears, go back to “KEYLESS LOCK ACKNOWLEDGMENT” and repeat the procedure again.

Security Relock Timer

If you unlock the doors and the tailgate with the remote transmitter, but do not open any of the doors or the tailgate within 30 seconds, the doors and the tailgate automatically relock and the security system sets.

You can change this relock time from 30 seconds to 60 or 90 seconds.

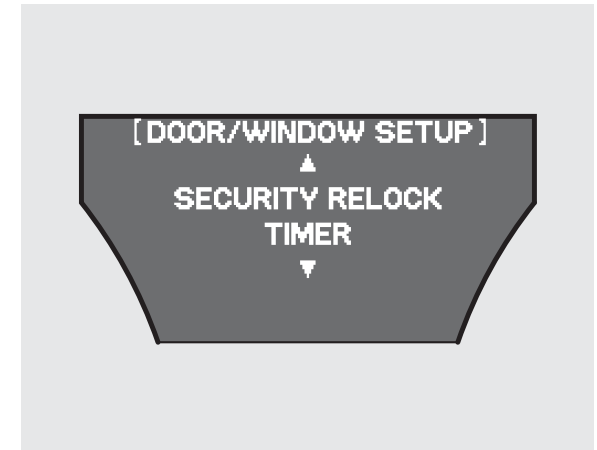

You can choose this customizable item from “DOOR/WINDOW SETUP” by pressing the INFO (▲/▼) button repeatedly.

CONTINUED

Multi-Information Display

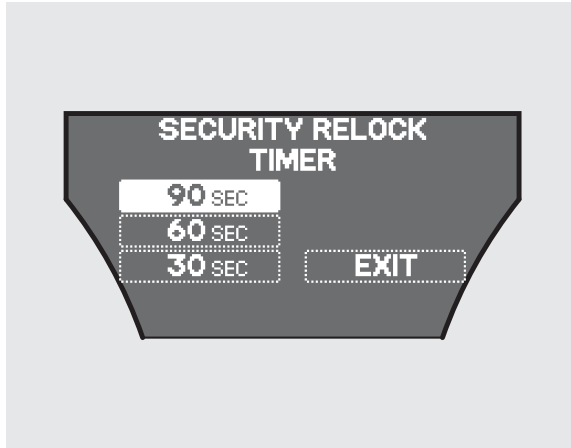

Press the SEL/RESET button to see the selections.

Select the desired setting by pressing the INFO (▲/▼) button, then enter your selection by pressing the SEL/RESET button.

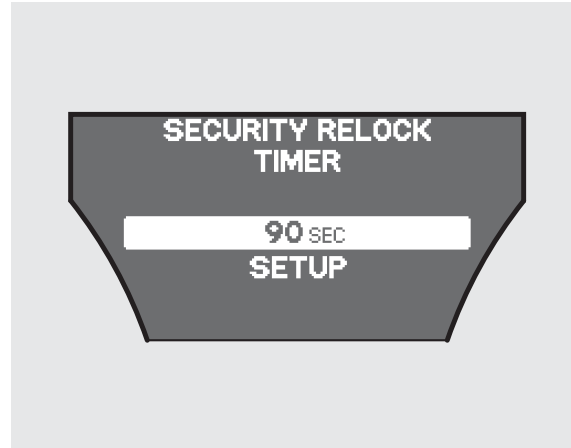

When your selection is successfully completed, the display changes as shown above, and then goes back to the customize item screen.

If the "SETTING INCOMPLETE" message appears, go back to "SECURITY RELOCK TIMER" and repeat the procedure again.

Wiper Setup

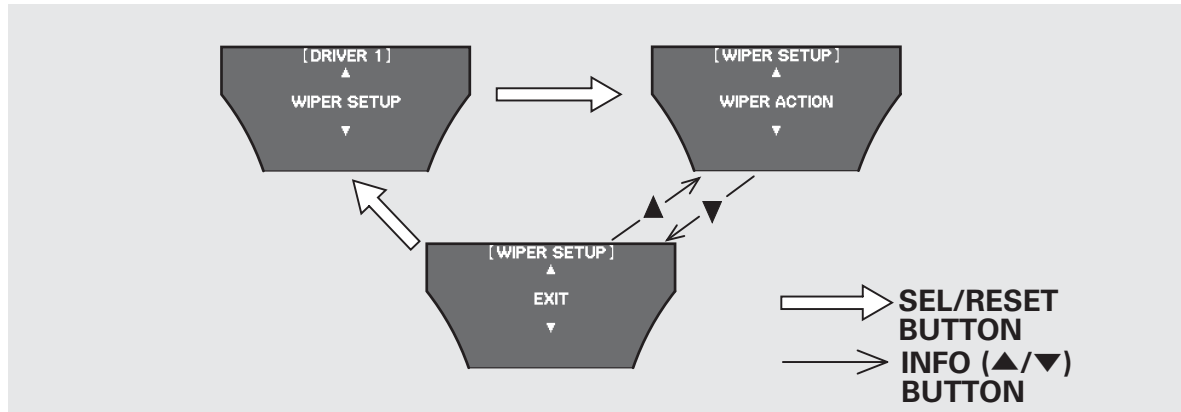

Here is one custom setting for the wiper setup:

- WIPER ACTION

While “WIPER SETUP” is shown, press the SEL/RESET button to enter the customize mode.

Each time you press the INFO (▲/▼) button, the screen changes as shown in the illustration. Press the INFO (▲/▼) button until you see the setting you want to customize, then press the SEL/RESET button to enter your selection.

Wiper Action

You can select from these two settings when the wiper switch is in the INT (intermittent) position:

INTERMITTENT – The intermittent operation varies according to the selection you make on the wiper lever's intermittent control ring.

WITH VEH SPD – The intermittent operation varies according to vehicle speed.

CONTINUED

Multi-Information Display

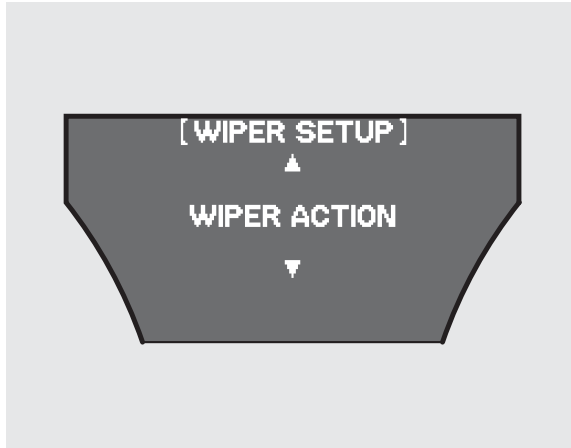

You can choose this customizable item from “WIPER SETUP” by pressing the INFO (▲/▼) button repeatedly.

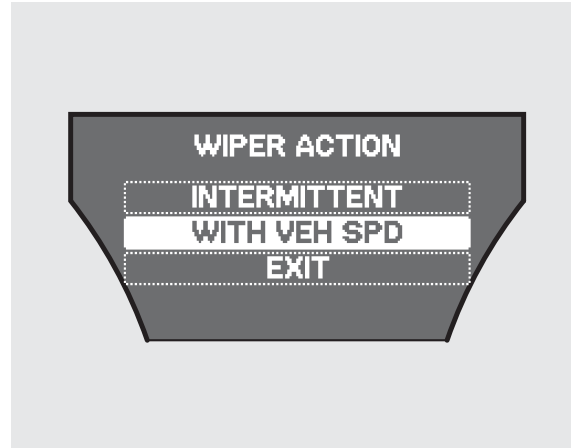

Press the SEL/RESET button to see the selections.

Select the desired setting by pressing the INFO (▲/▼) button, then enter your selection by pressing the SEL/RESET button.

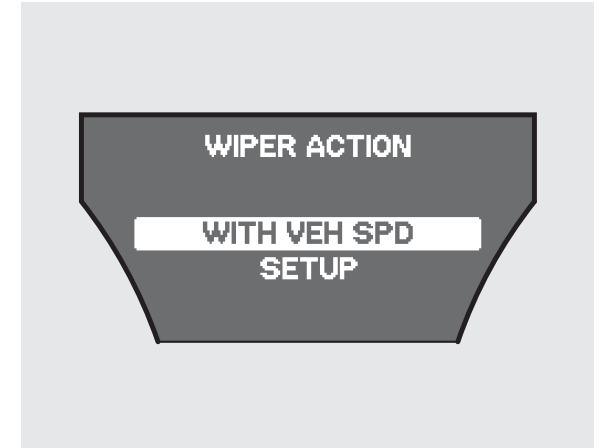

When your selection is successfully completed, the display changes as shown above, and then goes back to the customize item screen.

If the “SETTING INCOMPLETE” message appears, go back to “WIPER ACTION” and repeat the procedure again.

Controls Near the Steering Wheel

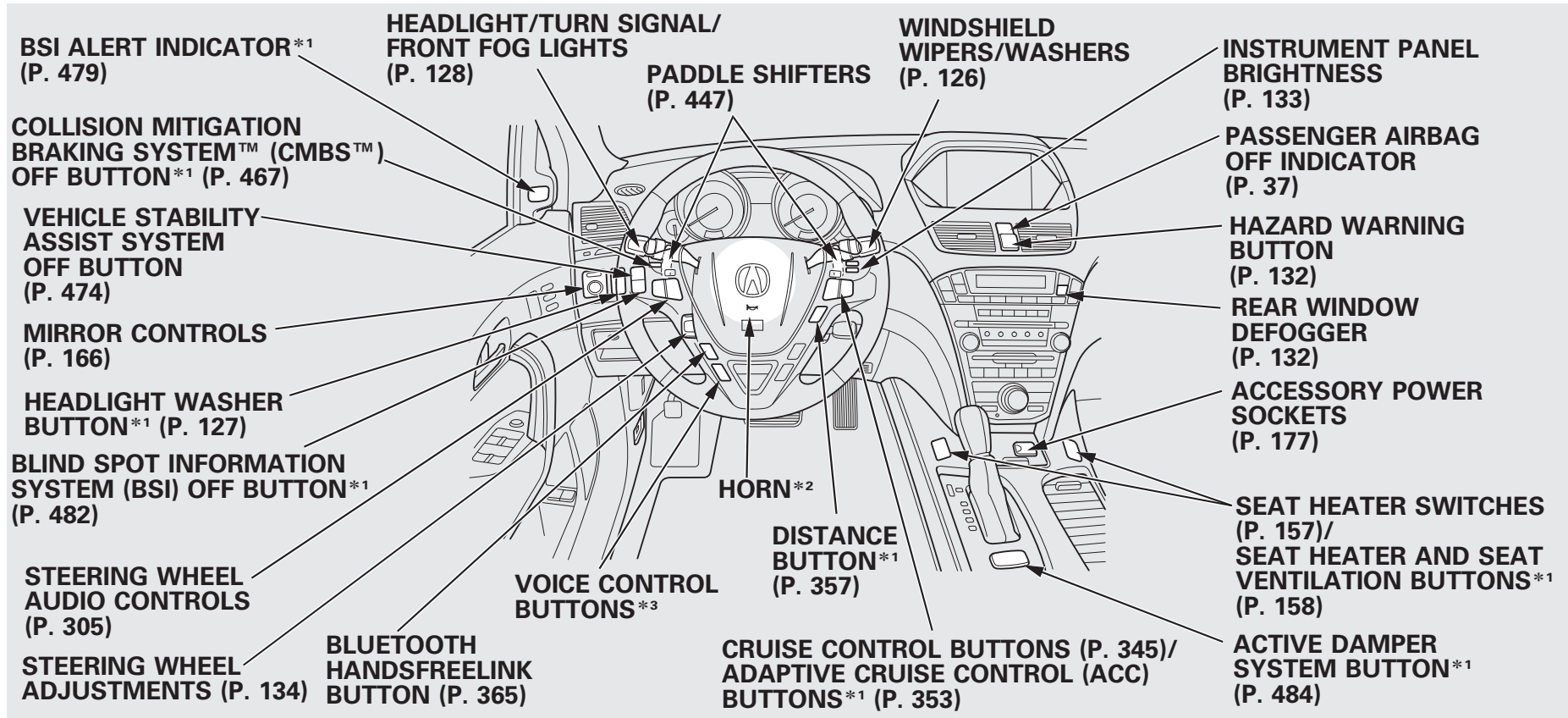

* 1: If equipped

* 2: To use the horn, press the center pad of the steering wheel.

* 3: Refer to the navigation system manual. For how to operate *Bluetooth*® HandsFreeLink by voice, see page 383.

Windshield Wipers and Washers

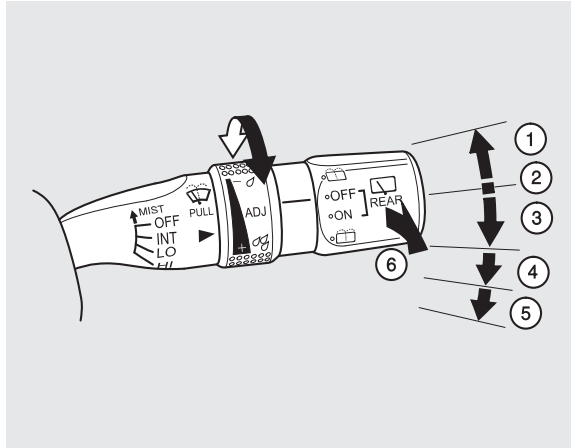

1. MIST
2. OFF
3. INT – Intermittent
4. LO – Low speed
5. HI – High speed
6. Windshield washers

Push the right lever up or down to select a position.

MIST – The wipers run at high speed until you release the lever.

OFF – The wipers are not activated.

INT – The length of the wipe interval is varied automatically according to vehicle speed.

Vary the delay by turning the adjustment ring. If you turn it to the shortest delay (☔ position), the wipers change to low speed operation when the vehicle speed exceeds 12 mph (20 km/h).

To change the “WIPER ACTION” setting, see page 123.

LO – The wipers run at low speed.

HI – The wipers run at high speed.

Windshield Washer – Pull the wiper control lever toward you, and hold it. The washers spray until you release the lever. The wipers run at low speed, then complete one more sweep after you release the lever.

When you activate the windshield washer with the headlights turned on, the headlight washer will be activated under certain conditions. For more information, see following *Headlight Washers* section.

Windshield Wipers and Washers

Headlight Washers (On Canadian models)

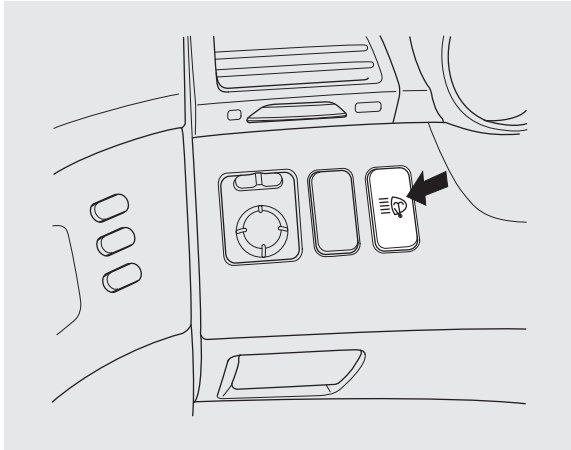

The headlight washers can be operated at any time by pressing the headlight washer button located next to the steering wheel column. The headlights must be turned on to use this button. In addition, the headlight washer operates without pressing the button the first time you turn on the windshield washers with the ignition switch in the ON (II) position.

The headlight washers use the same fluid reservoir as the windshield washers.

Rear Window Wiper and Washer

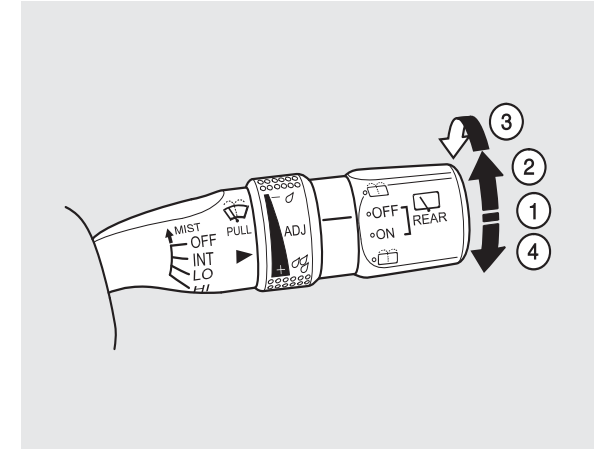

1. Rotate the switch clockwise to turn the rear window wiper ON.
2. Hold past ON to turn the rear window wiper on and to spray the rear window washer.

CONTINUED

Windshield Wipers and Washers, Turn Signal and Headlights

- When you turn the wiper switch to the “OFF” position, the wiper will return to its parked position.
- Rotate the switch counterclockwise to spray the window washer.

When you shift the transmission to the reverse position with the front windshield wipers activated, the rear window wiper operates automatically.

When the wiper control lever position is INT, the rear wiper operates intermittently. When it is LO or HI, the rear wiper operates continuously.

The rear window washer uses the same fluid reservoir as the windshield washer.

Turn Signal and Headlights

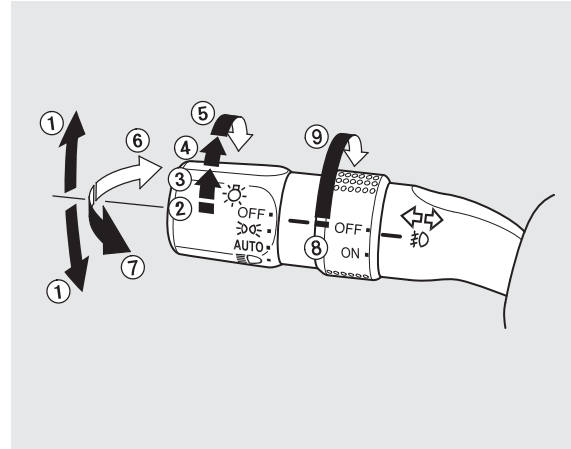

- Turn signal
- Off
- Parking and indicator lights
- AUTO
- Headlights on
- High beams
- Flash high beams
- Fog lights off
- Fog lights on

Turn Signal – Push down on the lever to signal a left turn and up to signal a right turn. To signal a lane change, push lightly on the lever, and hold it. The lever will return to center when you release it or complete a turn.

Headlights On – Turning the switch to the “☰” position turns on the parking lights, taillights, instrument panel lights, side-marker lights, and rear license plate lights.

Turning the switch to the “☰D” position turns on the headlights. If you leave the lights on with the key removed from the ignition switch, you will hear a reminder chime when you open the driver's door.

When the light switch is in either of these positions, the lights on indicator comes on as a reminder.

This indicator stays on if you leave the lights on and turn the ignition switch to the ACCESSORY (I) or LOCK (0) position.

High Beams – To switch from low beams to high beams, push the left lever forward until you hear a click. The blue high beam indicator will come on (see page 74). Pull it back to return to low beams. To flash the high beams, pull the lever back lightly, then release it. The high beams stay on as long as you hold the lever back.

AUTO – The automatic lighting feature turns on the headlights and all other exterior lights, when it senses low ambient light.

To turn on automatic lighting, turn the light switch to AUTO at any time. The lights will come on automatically when the outside light level becomes low (at dusk, for example). The lights on indicator comes on as a reminder. The lights and indicator will turn off automatically when the system senses high ambient light.

The lights will remain on when you turn off the ignition switch. They will turn off automatically when you remove the key and open the driver's door. To turn them on again, either turn the ignition switch to the ON (II) position or turn the light switch to the  position.

Even with the automatic lighting feature turned on, we recommend that you turn on the lights manually when driving at night or in a dense fog, or when you enter dark areas such as long tunnels or parking facilities.

To change the “AUTO LIGHT SENSITIVITY” setting, see page 113.

Do not leave the light switch in AUTO if you will not be driving the vehicle for an extended period (a week or more). You should also turn off the lights if you plan to leave the engine idling or off for a long time.

CONTINUED

Turn Signal and Headlights

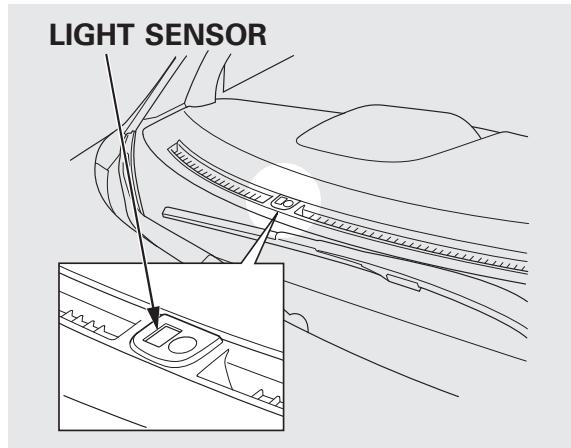

The automatic lighting feature is controlled by a sensor located on top of the dashboard. Do not cover this sensor or spill liquids on it.

Fog Lights

Turn the fog lights on and off by turning the switch next to the headlight switch.

You can use the fog lights only when the headlights are on low beam. With the light switch in the AUTO position, you can also use the fog lights when the headlights turn on automatically. They will go off when the headlights turn off.

Daytime Running Lights

With the headlight switch off, the daytime running lights come on when you turn the ignition switch to the ON (II) position and release the parking brake. They remain on until you turn the ignition switch off, even if you set the parking brake.

When the headlights are on, the daytime running lights are off.



If you see a “CHECK DRL SYSTEM” message on the multi-information display, there is a problem with the daytime running light system. Take your vehicle to a dealer to have it checked.

When the multi-information display shows a “DRL OFF” message, the daytime running lights are off. Follow the procedure in the left column to turn them on.

Automatic Lighting Off Feature

This feature turns off the headlights, all other exterior lights, and the instrument panel lights within 15 seconds after you remove the key and close the driver's door.

To change the “HEADLIGHT AUTO OFF TIMER” setting, see page 112.

The automatic lighting off feature activates if you leave the headlight switch in the “ ” or “ ” position or if the lights are turned on by setting the switch in the “AUTO” position, and you remove the key, then open and close the driver's door.

If you turn the ignition switch to the LOCK (0) position with the headlight switch on, but do not open the door the lights turn off after 10 minutes (3 minutes, if the switch is in the “AUTO” position).

The lights turn on again when you unlock or open the driver's door. If you unlock the door, but do not open it within 15 seconds, the lights go off. With the driver's door open, you will hear a lights-on reminder chime.

Hazard Warning Button, Rear Window Defogger

Hazard Warning Button

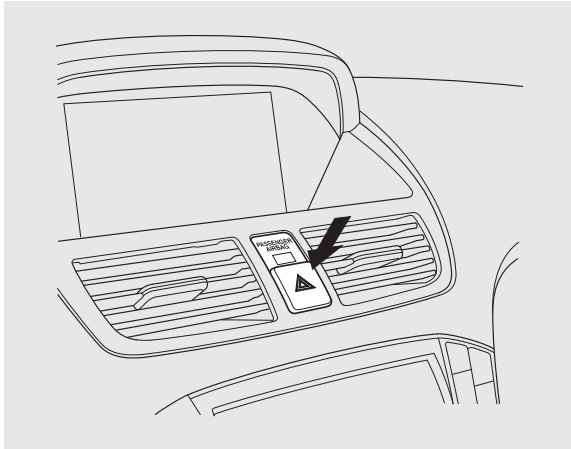

Push the button between the center vents to turn on the hazard warning lights (four-way flashers). This causes all four outside turn signals and both indicators in the instrument panel to flash. Use the hazard warning lights if you need to park in a dangerous area near heavy traffic, or if your vehicle is disabled.

Rear Window Defogger

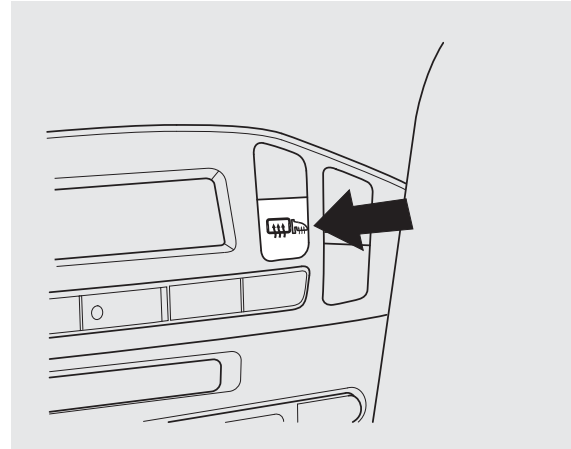

The rear window defogger will clear fog, frost, and thin ice from the window. Push the defogger button to turn it on and off. The indicator in the button lights to show the defogger is on. If you do not turn it off, the defogger will shut itself off after about 15 minutes. It also shuts off when you turn off the ignition. You have to turn it on again when you restart the vehicle.

Make sure the rear window is clear and you have good visibility before starting to drive.

The defogger wires on the inside of the rear window can be accidentally damaged. When cleaning the glass, always wipe side-to-side.

Pushing this button also turns the mirror heaters on or off. For more information, see page 167.

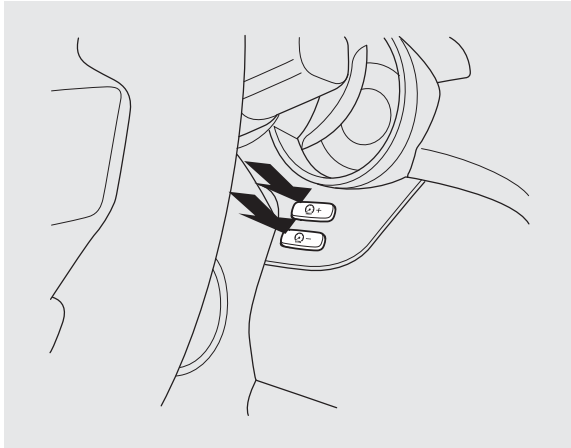

Instrument Panel Brightness

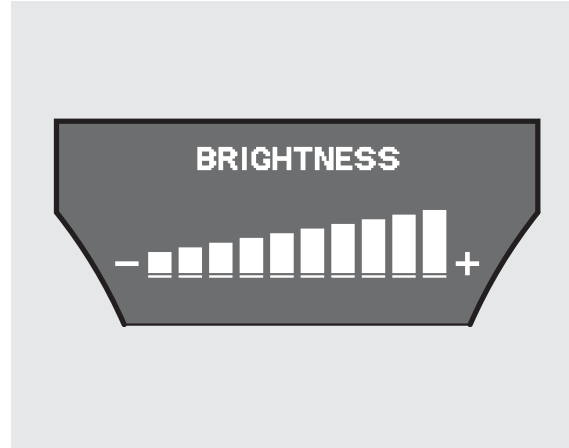

Adjust the brightness of the instrument panel by pressing the + or - button. Press the + button to increase the brightness and the - button to decrease it. The brightness can be set differently for when the headlights are on, and when they are off.



The level of brightness is shown on the multi-information display while you adjust it. It goes out 5 seconds after you finish adjusting.

To reduce glare at night, the instrument panel illumination dims when you turn the light switch to  or . To cancel the glare reduction function, set the brightness to the highest level, then press the + button. You will hear a beep when it is canceled.

You can customize when the glare reduction function starts. To change “AUTO INTERIOR ILLUMINATION”, see page 105 for more information.

Steering Wheel Adjustments

Make any steering wheel adjustment before you start driving.

⚠ WARNING

Adjusting the steering wheel position while driving may cause you to lose control of the vehicle and be seriously injured in a crash.

Adjust the steering wheel only when the vehicle is stopped.

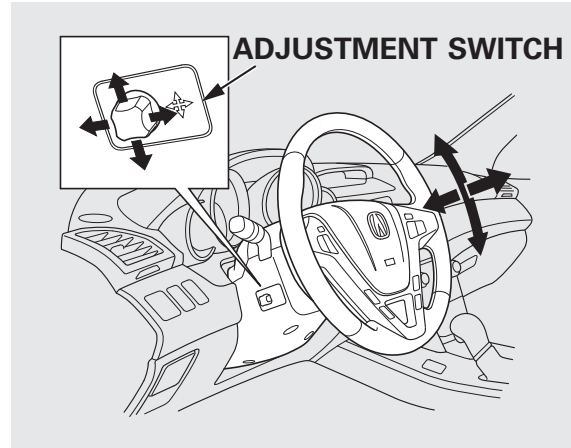

Move the steering wheel in, out, up, or down by pushing and holding the adjustment switch in that direction.

Release the switch when the steering wheel reaches the desired position. Make sure the steering wheel points towards your chest, not toward your face, and that you can see the instrument panel gauges and indicators.

When you remove the key from the ignition switch, the steering wheel automatically moves fully in and up.

To change the “AUTO TILT & TELESCOPE STEERING WHEEL” setting, see page 109.

The steering wheel then returns to its original position when you insert the key back in the ignition switch.

Steering wheel movement is also controlled by the driving position memory system (see page 168).

If your vehicle's battery is disconnected or goes dead, or the fuse for the power tilt and telescopic steering wheel is removed, the power tilt and telescopic steering wheel system needs to be reset when you reconnect the battery or install the fuse.

Insert the key into the ignition switch, and remove it. The steering wheel automatically moves fully in and up to let you know the system is reset.

Keys and Locks

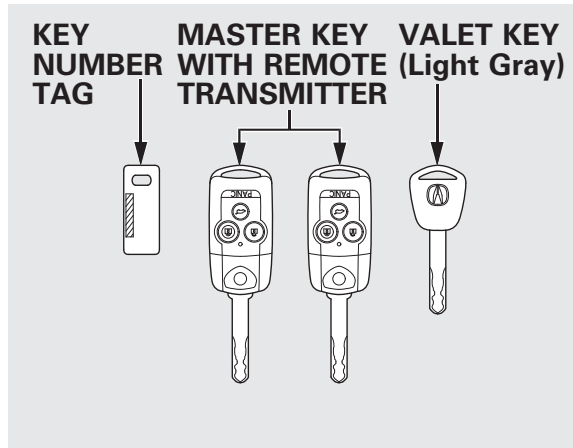

The master key fits all the locks on your vehicle. The valet key works only in the ignition and the driver's door lock. You can keep the glove box locked when you leave your vehicle and the valet key at a parking facility.

You should have received a key number tag with your keys. You will need this key number if you ever have to get a lost key replaced. Use only Acura-approved key blanks.

These keys contain electronic circuits that are activated by the immobilizer system. They will not work to start the engine if the circuits are damaged.

- Protect the keys from direct sunlight, high temperature, and high humidity.
- Do not drop the keys or set heavy objects on them.
- Keep the keys away from liquids. If they get wet, dry them immediately with a soft cloth.

The valet key does not contain a battery. Do not try to take it apart.

Retractable Master Key

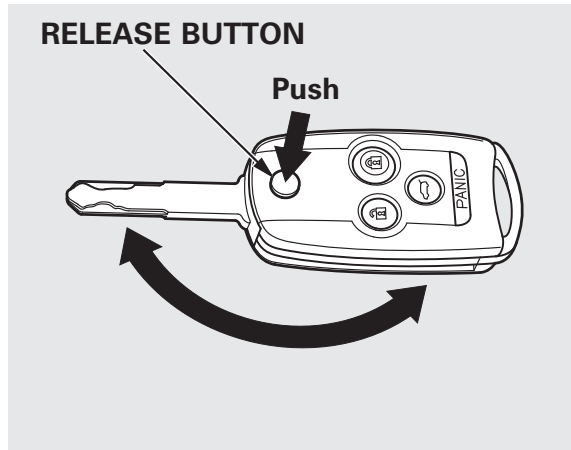

The master key can be retracted into the remote transmitter. To use the key, push the release button to release the key from the transmitter. The key should be fully extended. To retract the key, push the release button and at the same time push the key into the remote transmitter until it is securely latched.

Always use the fully-extended key when you insert it to the ignition switch. If the key does not fully extend, the immobilizer system may not operate properly and may prevent the engine from starting.

The key may come in contact with your finger while being retracted or extended. Make sure your fingers do not touch the pivot of the key when retracting or extending the key.

Immobilizer System

The Immobilizer System protects your vehicle from theft. If an improperly coded key (or other device) is used, the engine's fuel system is disabled.

When you turn the ignition switch to the ON (II) position, the immobilizer system indicator should come on briefly, then go off. If the indicator starts to blink, it means the system does not recognize the coding of the key. Turn the ignition switch to the LOCK (0) position, remove the key, reinsert it, and turn the ignition switch to the ON (II) position again.

The system may not recognize your key's coding if another immobilizer key or other metal object (i.e. key chain) is near the ignition switch when you insert the key.

If the system repeatedly does not recognize the coding of your key, contact your dealer.

Do not attempt to alter this system or add other devices to it. Electrical problems could result that may make your vehicle inoperable.

If you have lost your key and you cannot start the engine, contact your dealer.

NOTICE

Always take the ignition key with you whenever you leave the vehicle alone.

*As required by the FCC:
This device complies with Part 15 of the FCC rules. Operation is subject to the following two conditions: (1) This device may not cause harmful interference, and (2) this device must accept any interference received, including interference that may cause undesired operation.*

Changes or modifications not expressly approved by the party responsible for compliance could void the user's authority to operate the equipment.

*This device complies with Industry Canada Standard RSS-210.
Operation is subject to the following two conditions: (1) this device may not cause interference, and (2) this device must accept any interference that may cause undesired operation of the device.*

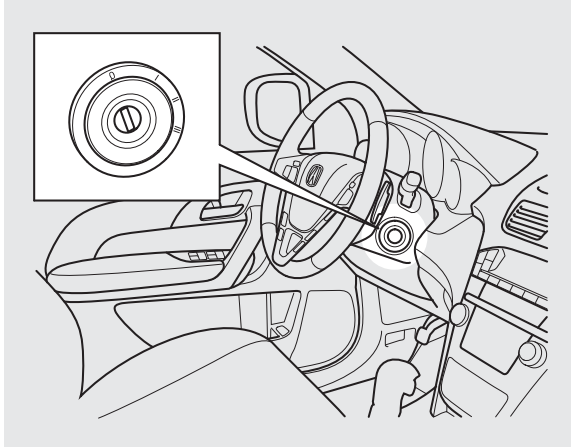

The ignition switch has four positions: LOCK (0), ACCESSORY (I), ON (II), and START (III).

LOCK (0) – You can insert or remove the key only in this position. To turn the key to the LOCK (0) position, the shift lever must be in Park, and you must push the key in slightly.

If the front wheels are turned, the anti-theft lock may make it difficult to turn the key. Firmly turn the steering wheel to the left or right as you turn the key.

ACCESSORY (I) – You can operate the audio system and the accessory power sockets in this position.

ON (II) – This is the normal key position when driving. Several of the indicators on the instrument panel come on as a test when you turn the ignition switch from the ACCESSORY (I) to the ON (II) position.

START (III) – Use this position only to start the engine. The switch returns to the ON (II) position when you let go of the key.

You will hear a reminder beeper if you leave the key in the ignition switch in the LOCK (0) or the ACCESSORY (I) position and open the driver's door. Remove the key to turn off the beeper.

The shift lever must be in Park before you can remove the key from the ignition switch.

Door Locks

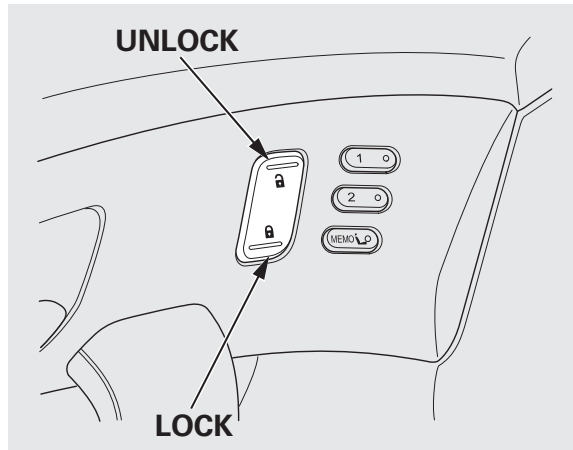

To lock all doors and the tailgate, press the bottom of the master door lock switch on either front door, pull the lock tab above the driver's door handle, or use the key on the outside lock on the driver's door.

Pressing the top of either master door lock switch will unlock all doors and the tailgate.

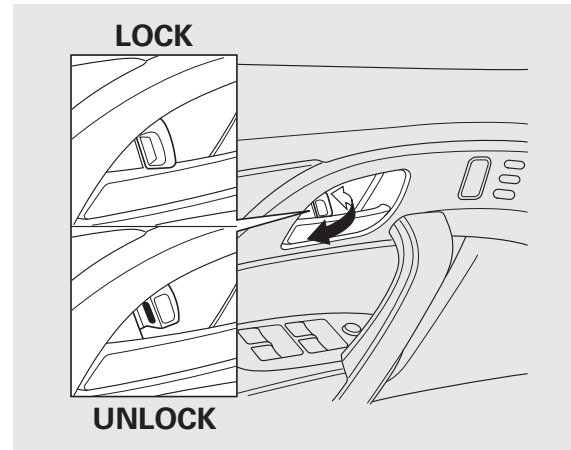

The lock tab on any passenger's door locks and unlocks that door.

All doors and the tailgate can be locked from the outside by using the key in the driver's door lock. To unlock only the driver's door, insert the key, turn the key, and release it. The remaining doors and the tailgate unlock when you turn the key a second time within a few seconds.

To change the “KEY AND REMOTE UNLOCK MODE” setting, see page 119.

When the vehicle speed reaches about 10 mph (about 16 km/h) or more, all the doors lock automatically.

To change the “AUTO DOOR LOCK” setting, see page 116.

When you shift to P after driving, the driver's door unlocks.

To change the “AUTO DOOR UNLOCK” setting, see page 117.

Lockout Prevention

With any door and the tailgate open and the key in the ignition, both master door lock switches are disabled. They are not disabled if all the doors and the tailgate are closed. If you try to lock an open driver's door by pulling the lock tab rearward the lock tab on the driver's door pops out.

Childproof Door Locks

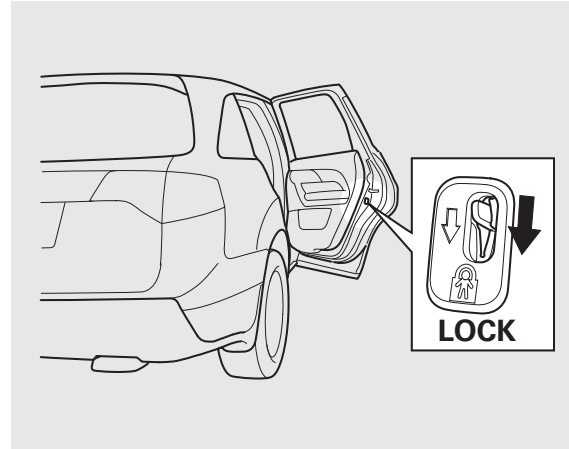

The childproof door locks are designed to prevent children seated in the rear from accidentally opening the rear doors. Each rear door has a lock lever near the edge. With the lever in the LOCK position (lever is down), the door cannot be opened from the inside regardless of the position of the lock tab. To open the door, push the lock tab forward and use the outside door handle.

Tailgate

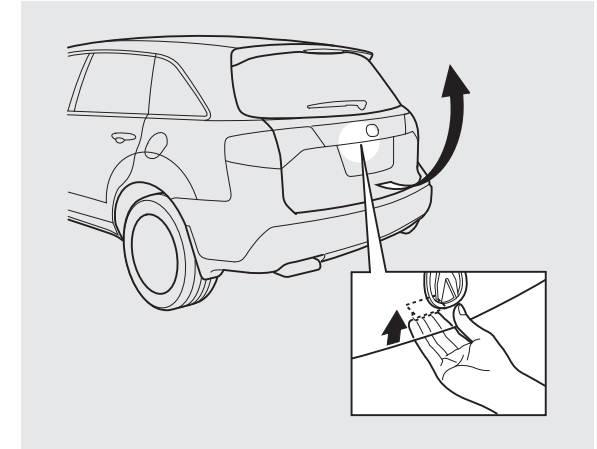

To open the tailgate, push up inside the handle, then lift up. To close the tailgate, use the inner handle to pull it down, then press down on the back edge.

Keep the tailgate closed at all times while driving to avoid damaging the tailgate and to prevent exhaust gas from getting into the interior. See **Carbon Monoxide Hazard** on page 61.

Tailgate

Power Tailgate

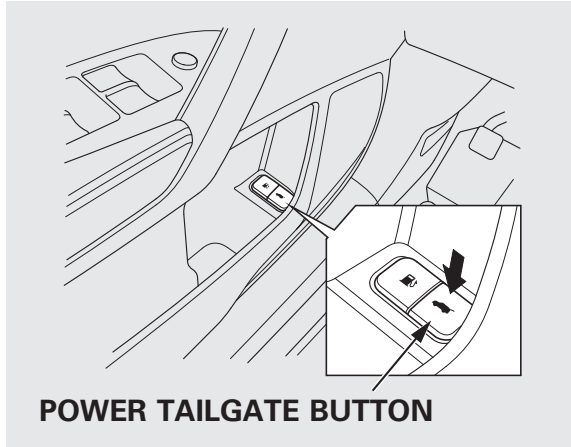

The tailgate can be opened and closed with the remote transmitter (see page 145) or the button in the driver's door pocket when both front doors are unlocked.

Press and hold the tailgate button on the remote transmitter or the button for about 1 second to open or close the tailgate. Each time you press the button on the remote transmitter or the button, you will hear a beep, and some front and rear lights will flash.

If you push the same button again while the tailgate is opening or closing, you will hear three beeps, and the tailgate will stop moving, reverse direction, and stop at the fully opened or closed position.

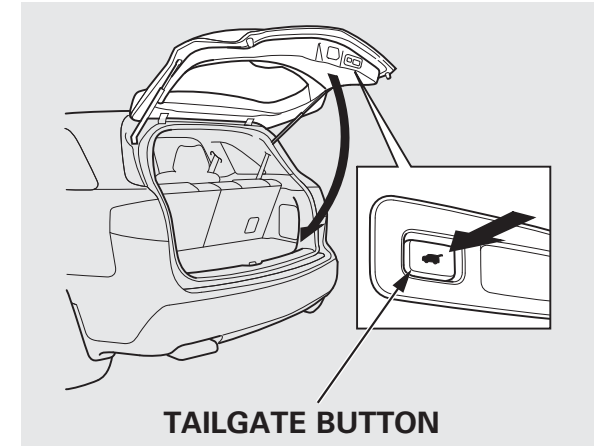

The tailgate can also be closed by pressing the button on the tailgate. If you press the button again while the tailgate is closing, you will hear three beeps, and the tailgate will stop moving, reverse direction, and stop at the fully opened position.

Auto-Reverse

The power tailgate has an auto-reverse feature. If it meets resistance while opening or closing, it will beep three times and reverse direction. However, the tailgate may not reverse immediately. Always make sure passengers and objects are clear of the tailgate before opening or closing it.

⚠ WARNING

Closing a power tailgate while anyone is in the path of the tailgate can cause serious injury.

Make sure everyone is clear before closing the power tailgate.

Also check that passengers, especially children, do not have their hands on the edge of the tailgate or on the tailgate sill. The auto reverse feature stops working when the tailgate is about to latch so the motor can pull the tailgate shut.

If your vehicle's battery is disconnected, goes dead, or the fuse is removed while the tailgate is fully open, the power tailgate needs to be reset. After connecting the battery or installing the fuse, close the tailgate fully by hand.

The power tailgate may not open or close under the these conditions:

- The vehicle is parked on a steep hill.
- When the vehicle is swayed in a strong wind.

- When the tailgate or the roof is covered with snow or ice.

Do not install any accessories on the tailgate. It may cause the tailgate to malfunction. If there is snow or ice on the tailgate, make sure to remove it before you operate the tailgate.

If you push the tailgate release button inside the handle while the tailgate is opening or closing, it will stop moving. You need to open or close it the rest of the way manually.

The tailgate has sensors on both sides. Be careful not to damage them. If the sensors are damaged, the power tailgate does not function properly.

CONTINUED

Tailgate

If you try to drive off with the tailgate not closed completely, a beeper sounds and a “DOOR & TAILGATE OPEN” message is shown on the multi-information display.

Keep the tailgate closed at all times while driving to avoid damaging the tailgate and to prevent exhaust gas from getting into the interior. See **Carbon Monoxide Hazard** on page 61.

If there is a problem in the power tailgate system, you will see a “CHECK POWER TAILGATE” message on the multi-information display. Have the system checked by your dealer.

With this message shown on the multi-information display, you can still open or close the tailgate manually.

Unlocking the Tailgate

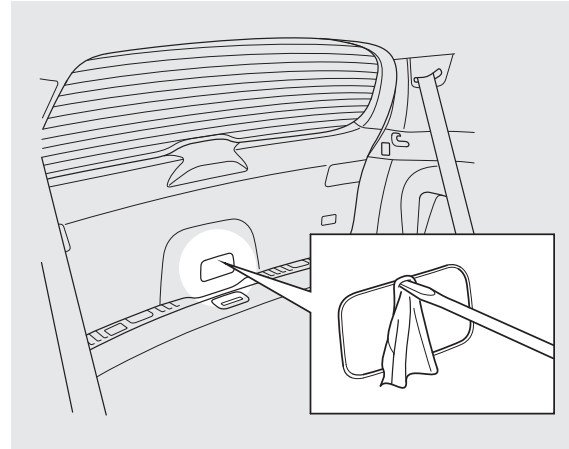

If the power door lock system cannot unlock the tailgate, unlock it manually.

Use a small flat-tip screwdriver to remove the cover on the back of the tailgate.

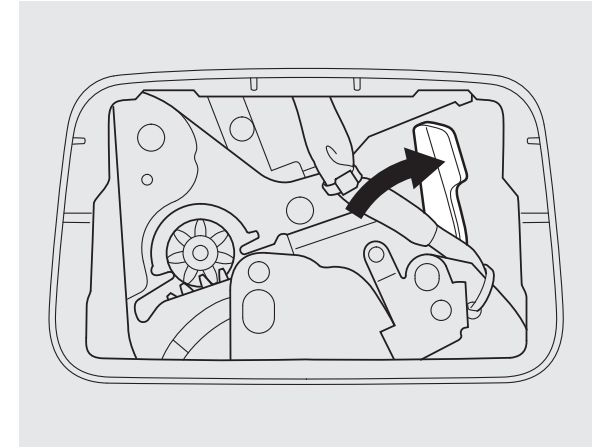

Push the release lever to the right as shown.

If you need to unlock the tailgate manually, it means there is a problem with the tailgate. Have the vehicle checked by your dealer.

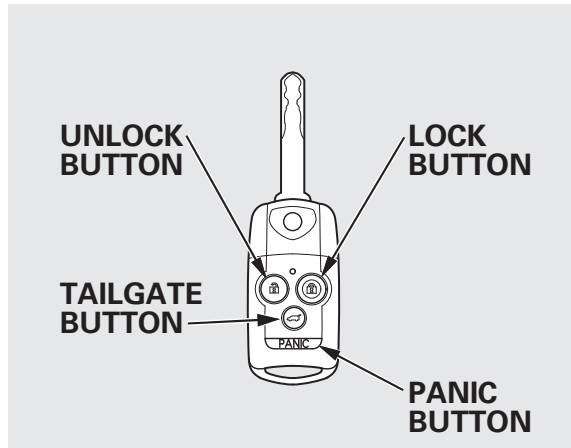

LOCK – Press this button once to lock all doors and the tailgate. Some exterior lights will flash. When you push LOCK twice within 5 seconds, you will hear a beep to verify that the doors and tailgate are locked and the security system has set. This button does not work if any door or tailgate is not fully closed.

To change the “KEYLESS LOCK ACKNOWLEDGEMENT” setting, see page 120.

UNLOCK – Press this button once to unlock the driver's door. Push it twice to unlock the other doors. Some exterior lights will flash twice when you push the button. If you do not open any door or the tailgate within 30 seconds, they will automatically relock.

To change the “KEY AND REMOTE UNLOCK MODE” setting, see page 119.

To change the “SECURITY RELOCK TIMER” setting, see page 121.

The door activated spotlights come on when you press the UNLOCK button if the door activated position is selected by pressing the light control button (DOOR). If you do not open any door within 30 seconds (or whatever setting of the interior light dimming time is set to), the lights will fade out. If you relock the doors with the remote transmitter before 30 seconds have elapsed, the lights will go off immediately.

TAILGATE – Press and hold the TAILGATE button to open or close the power tailgate. When the tailgate begins to move, you will hear a beep, and some front and rear lights will flash.

CONTINUED

Remote Transmitter

If you push the same button again while the tailgate is opening or closing, three beeps sound, the tailgate stops moving, reverses direction and stops in the fully opened or fully closed position.

PANIC – Press and hold this button for about 1 second to attract attention; the horn will sound, and the exterior lights will flash for about 30 seconds. To cancel panic mode, press any other button on the remote transmitter, or turn the ignition switch to the ON (II) position. Panic mode does not work when the key is in the ignition switch.

Remote Transmitter Care

- Avoid dropping or throwing the transmitter.
- Protect the transmitter from extreme temperatures.
- Do not immerse the transmitter in any liquid.
- If you lose a transmitter, the replacement needs to be reprogrammed by your dealer.

Replacing the Transmitter Battery

If it takes several pushes on the button to lock or unlock the doors and the tailgate, replace the battery as soon as possible.

Battery type: CR1616

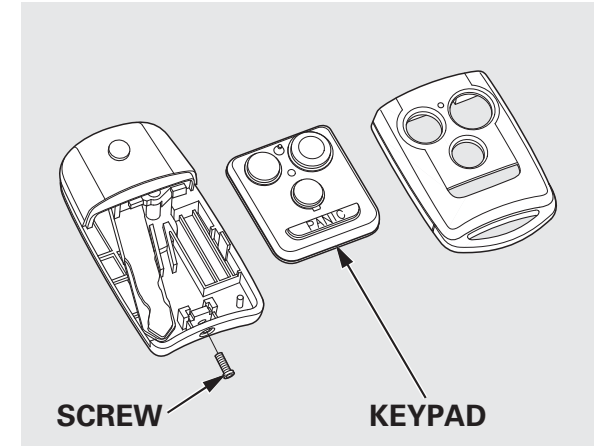

To replace the battery:

1. Remove the screw at the base of the transmitter with a small Phillips-head screwdriver.

NOTE: Be careful when removing this screw as the head of the screw can strip out.

2. Separate the keypad from the transmitter by pushing any button from outside.

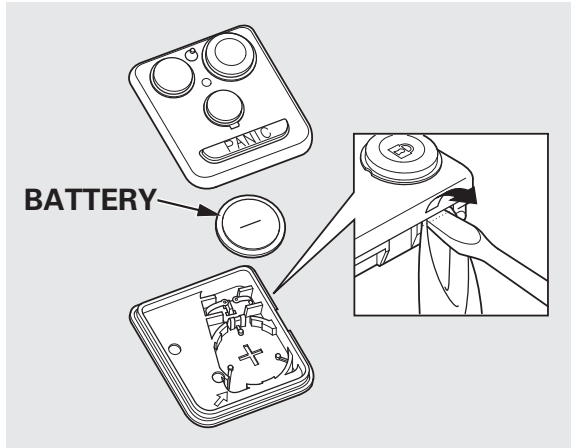

3. Place a cloth on the edge of the keypad to prevent scratches, and remove the upper half by carefully prying on the edge with a small flat-tip screwdriver.

4. Remove the old battery and note the polarity. Make sure the polarity of the new battery is the same (– side facing up), then insert it in the keypad.

An improperly disposed of battery can hurt the environment. Always confirm local regulations for battery disposal.

5. Snap the two halves of the keypad, then install the parts in reverse order.

As required by the FCC:

This device complies with Part 15 of the FCC rules. Operation is subject to the following two conditions: (1) This device may not cause harmful interference, and (2) this device must accept any interference received, including interference that may cause undesired operation.

Changes or modifications not expressly approved by the party responsible for compliance could void the user's authority to operate the equipment.

This device complies with Industry Canada Standard RSS-210.

Operation is subject to the following two conditions: (1) this device may not cause interference, and (2) this device must accept any interference that may cause undesired operation of the device.

CONTINUED

Remote Transmitter

Recalling a Memorized Driving Position

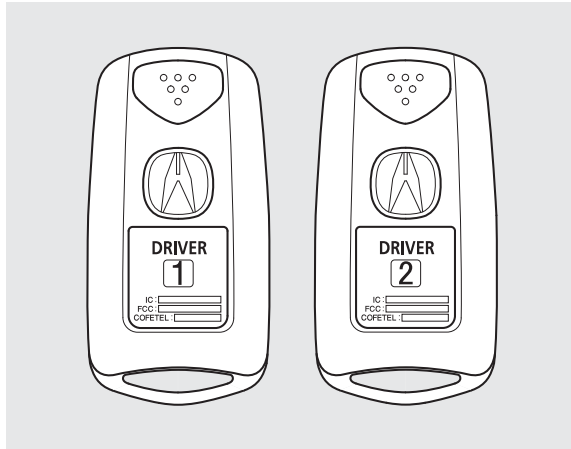

When you unlock the driver's door with your remote, each remote activates the keyless memory settings related to that remote. The driver's ID (DRIVER 1 or DRIVER 2) is shown on the back of each remote.

Here are the settings activated with the remote:

- Customized settings (see page 90).
- Driving position memory (see page 168).
- Audio system settings (see page 212).
- Climate control settings (see page 183).

When you unlock and open the driver's door with the remote transmitter, the driver's seat (except the power lumbar feature) and outside mirrors start to move to the positions stored in memory. The indicator in the related memory button to the remote comes on.

The steering wheel will move to the stored position when you insert the key into the ignition switch.

You will also see the “WELCOME DRIVER 1” or “WELCOME DRIVER 2” message on the multi-information display, depending on which linked remote transmitter is used.

Front Seat Power Adjustments

See pages 14 – 15 for important safety information and warnings about how to properly position the seats and seat-backs.

The controls for the power adjustable front seats are on the outside edge of each seat bottom. You can adjust the seats with the ignition switch in any position. Make all seat adjustments before you start driving.

The passenger seat has the same adjustments as the driver's seat but without any lumbar adjustment.

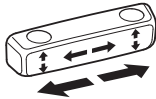
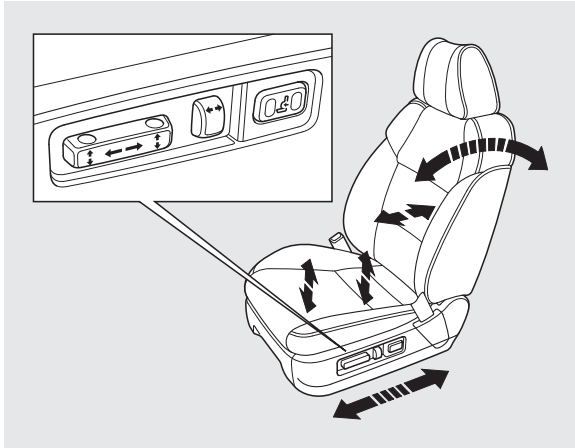

Moves the seat forward and backward.

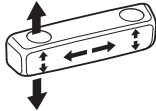

Moves the front of the seat up or down.

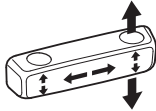

Raises or lowers the seat.

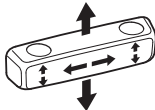

Moves the whole seat up and forward, or down and backward. The front of the seat also tilts up or down at the same time.



Adjusts the seat-back angle forward or backward.

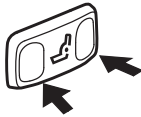

Increases or decreases the lumbar support. (Driver's seat only)

CONTINUED

Seats

Head Restraints

See page 15 for important safety information and a warning about improperly positioning head restraints.

Your vehicle is equipped with head restraints in all seating positions to help protect you and your passengers from the likelihood of whiplash and other injuries.

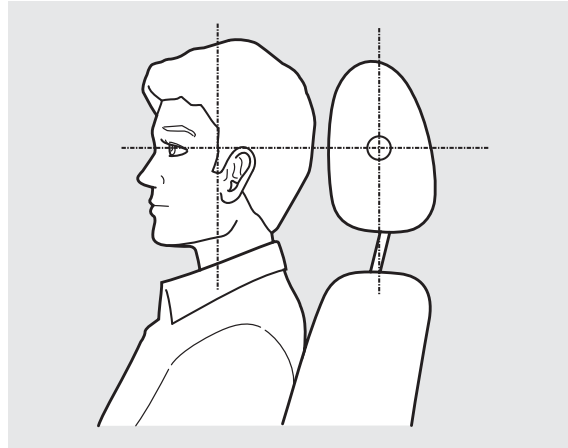

They are most effective when you adjust them so the center of the back of the occupant's head rests against the center of the restraint.

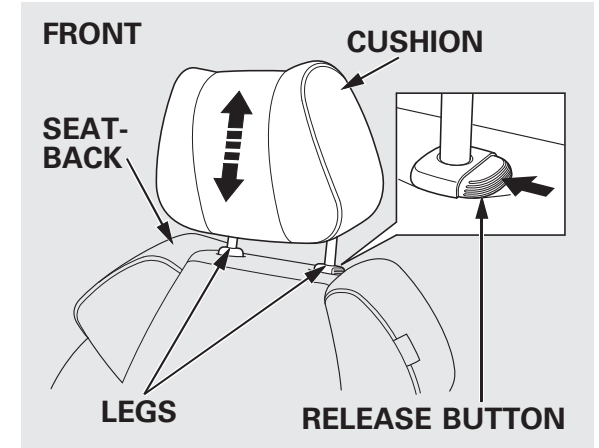

Adjusting the Head Restraint

The head restraints adjust for height. You need both hands to adjust the restraint. Do not attempt to adjust it while driving. To raise it, pull upward. To lower the restraint, push the release button sideways, and push the restraint down.

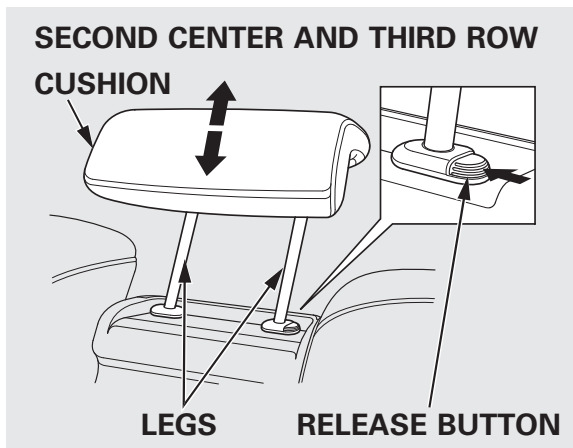

Removing the Head Restraint

To remove a head restraint for cleaning or repair, pull it up as far as it will go. Push the release button, then pull the restraint out of the seat-back.

When reinstalling a head restraint, put the legs back in place. Then adjust it to the appropriate height while pressing the release button.

Make sure the head restraint locks in position when you reinstall it.

⚠ WARNING

Failure to reinstall, or correctly reinstall, the head restraints can result in severe injury during a crash.

Always replace the head restraints before driving.

CONTINUED

Seats

Active Head Restraints

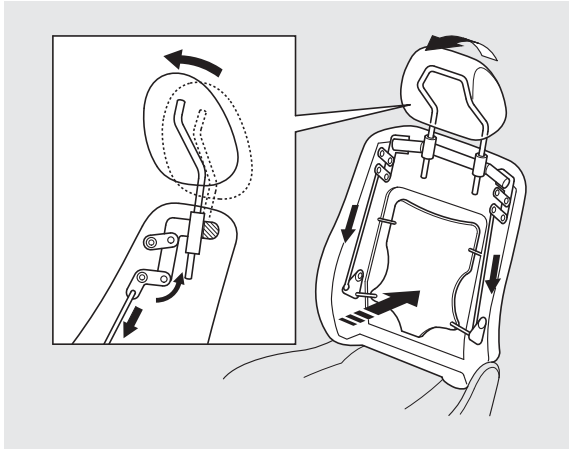

The driver's and front passenger's seats have active head restraints. If the vehicle is struck severely from the rear, the occupant properly secured with the seat belt will be pushed against the seat-back and the head restraint will automatically move forward.

This reduces the distance between the restraint and the occupant's head. It also helps protect the occupants against the likelihood of whiplash and injuries to the neck and upper spine.

After a collision, the activated restraint should return to its normal position.

If the restraints do not return to their normal position, or in the event of a severe collision, have the vehicle inspected by an Acura dealer.

For a head restraint system to work properly:

- Do not hang any items on the head restraints, or from the restraint legs.
- Do not place any object between an occupant and the seat-back.
- Install each restraint in its proper location.
- Only use genuine Acura replacement head restraints.

Adjusting the Second Row Seats

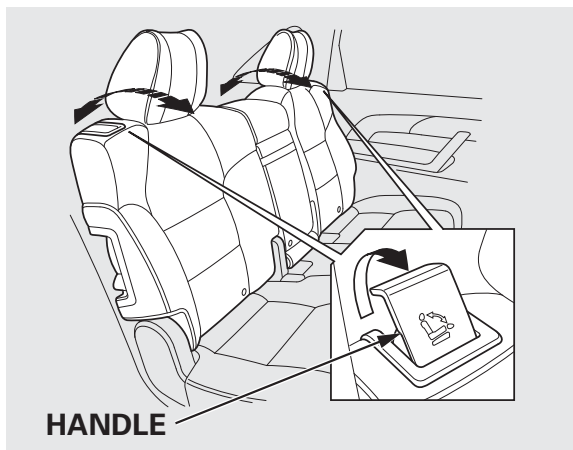

To change the seat-back angle of the seats in the second row, pull up on the handle on the outside of the seat-back, and push the seat-back.

Overall, the seat-back has six different positions.

Folding the Second Row Seats

The left and right halves can be folded separately.

1. To unlatch the detachable anchor before folding the seat-back, insert the latch plate into the slot on the side of the anchor buckle (see page 155) and allow the seat belt to retract. Store the detachable anchor and seat belt latch plates in the retractor housing.
2. Lower the head restraints to their lowest positions.
3. Pull up the handle on the outside of the seat-back.
4. Fold the seat-back forward.

Reverse this procedure to return the seat to the upright position. Make sure the seat is locked securely before driving.

Make sure that the folded seat-back does not press against the front passenger's seat, as this could cause the weight sensors to work improperly.

CONTINUED

Seats

Third Row Access

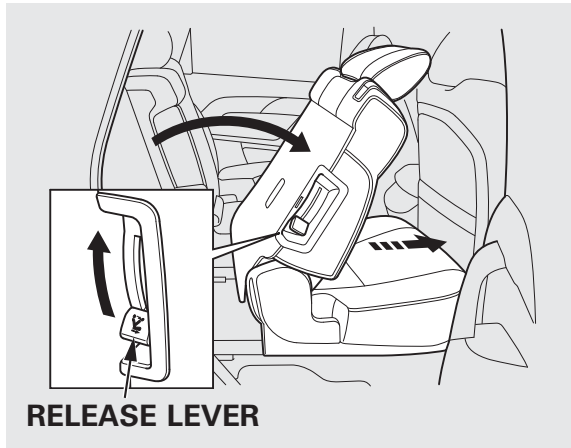

To get into the third row seats, pull up the lever on the side of the passenger's side second row seat-back. The seat-back will tilt forward, and then can be slid forward.

After you return the seat-back to the upright position, push the whole seat backwards until it latches. Make sure the seat is fully latched before sitting in it.

Folding the Third Row Seat

1. Use the latch plate to release the seat belt from the detachable anchor (see page 155).
2. Lower the head restraints to their lowest positions.

NOTE: To fold the third row seat, the second row seat-back must be folded down or in the full up right position.

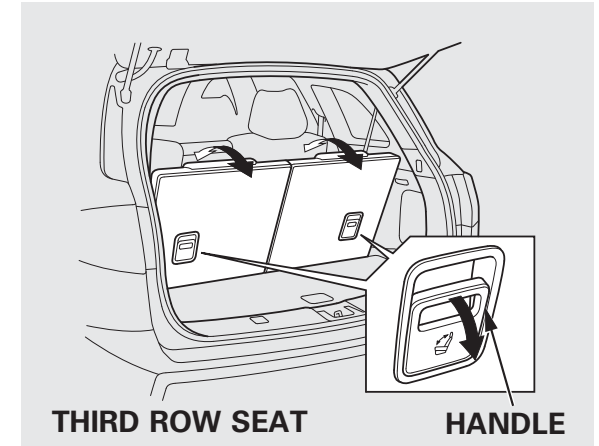

3. Unlock the seat-back by pulling the handle. Push the seat-back forward.

Make sure the outer shoulder belts are positioned on each hook on the side panel whenever the third seat is folded.

Reverse this procedure to return the seat to the upright position. Make sure the seat is locked securely before driving. Reconnect the seat belts to the detachable anchors.

Make sure all items in the cargo area are secured. Loose items can fly forward and cause injury if you have to brake hard (See **Carrying Cargo** on page 433).

Detachable Anchor

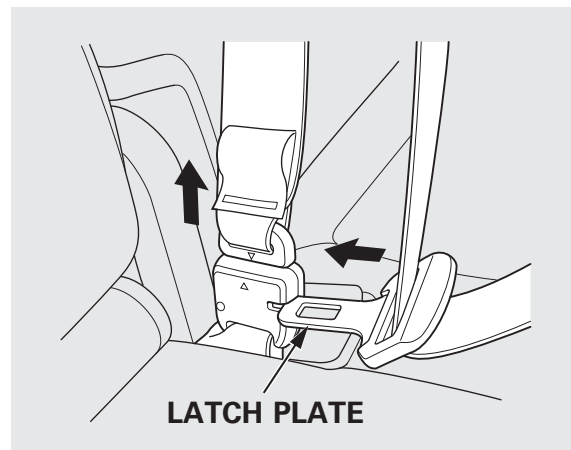

The seat belts in the second row center seat and the third row seats are equipped with detachable anchors.

To unlatch the detachable anchor, insert the latch plate into the slot on the side of the anchor buckle. Store the detachable anchor and seat belt latch plates in the retractor housing.

When the seats are returned to the upright position, these detachable anchors should be latched back properly.

⚠ WARNING

Using the seat belt with the detachable anchor unlatched increases the chance of serious injury or death in a crash.

Before using the seat belt, make sure the detachable anchor is correctly latched.

CONTINUED

Seats

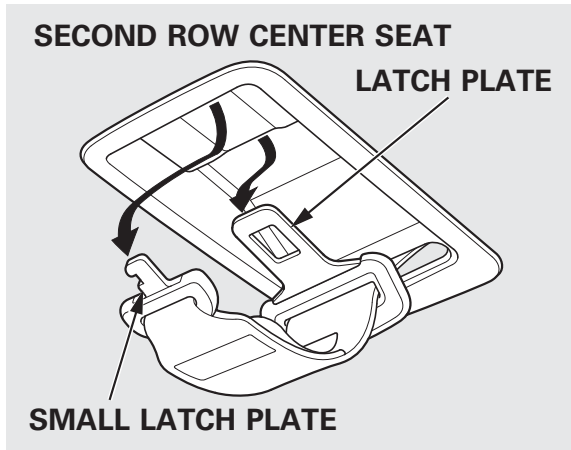

Pull out the small latch plate and the latch plate from each holding slot in the ceiling, and pull out the seat belt to extend it.

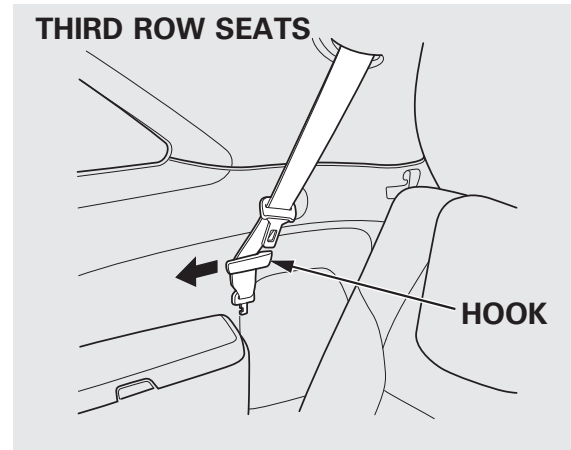

Pull out the outer shoulder belts from the hook. Both of the third-row hooks should only be used when the seat belt is detached.

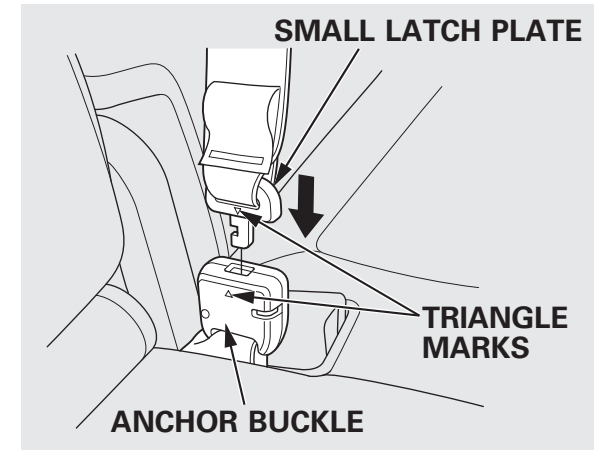

Line up the triangle marks on the small latch plate and anchor buckle when reattaching the belt and buckle.

Tug on the seat belt to verify that the detachable anchor is securely latched. Make sure the seat belt is not twisted.

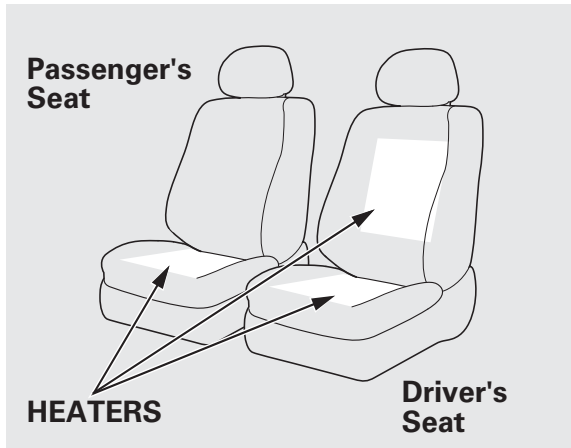

MDX, Technology Package, and U.S. Technology Package with Entertainment models

Both front seats are equipped with seat heaters. Because of the sensors for the side airbag cutoff system, there is no heater in the passenger's seat-back. The ignition switch must be in the ON (II) position to use the heaters.

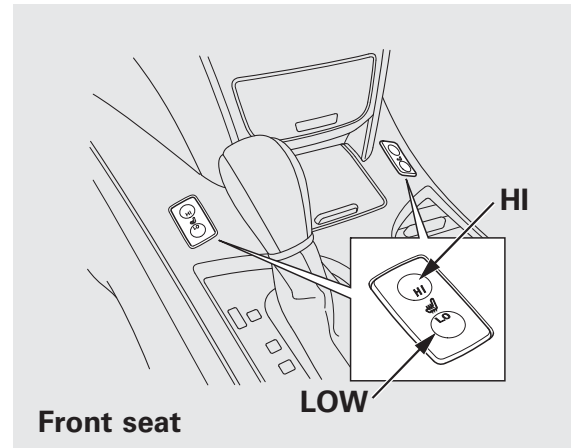

Push the front of the switch, HI, to rapidly heat up the seat. After the seat reaches a comfortable temperature, select LO by pushing the back of the switch. This will keep the seat warm.

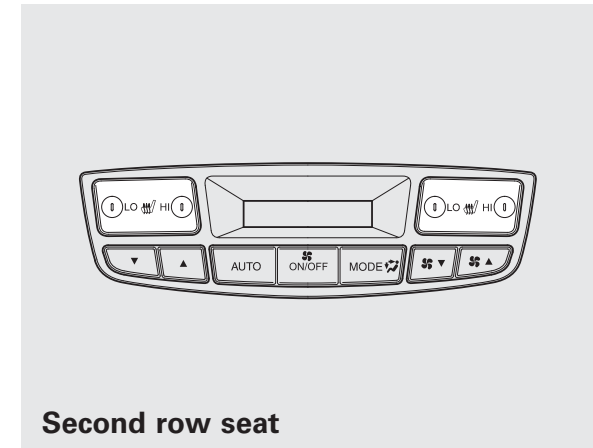

U.S. Technology Package with Entertainment, Advance Package with Entertainment and Canadian models
The outer second row seat cushions and seat-backs are equipped with seat heaters. Turning the switch on the driver side warms the outer seat behind the driver's seat only. The passenger side switch warms the outer seat behind the front passenger seat.

CONTINUED

Seat Heaters, Seat Heaters and Seat Ventilation

⚠ WARNING

Heat induced burns are possible when using seat heaters.

Persons with a diminished ability to sense temperature (e. g., persons with diabetes, lower-limb nerve damage, or paralysis) or with sensitive skin should not use seat heaters.

In the HI setting, the heater turns off when the seat gets warm, and turns back on after the seat's temperature drops.

In the LO setting, the heater runs continuously. It does not cycle with temperature changes.

Follow these precautions when using the seat heaters:

- Do not use the seat heater in the HI setting for an extended period, because it draws large amounts of current from the battery.
- If the engine is left idling for an extended period, do not use the seat heaters even on the LO setting. It can weaken the battery, causing hard starting.

Seat Heaters and Seat Ventilation

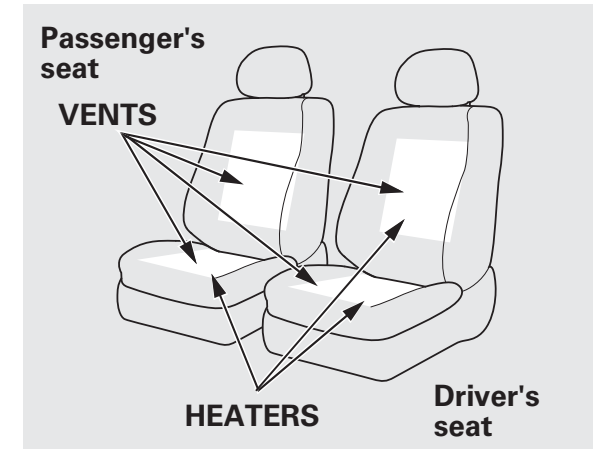

If equipped

Both front seats are equipped with seat heaters and an air ventilation system. The passenger seat only has heaters in the seat bottom because of the side airbag system.

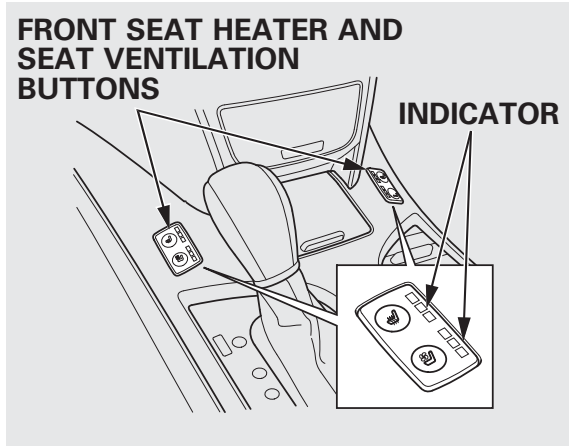

The ignition switch must be in the ON (II) position to use the heaters and the air ventilation system.

To use the heaters, press the  button. The indicator (red) next to the button will come on. There are four settings in the heaters:

- HI – Three indicators on.
- MID – Two indicators on.
- LO – One indicator on.
- OFF – All indicators off.

Pressing the  button while the heater is running will switch the system to the HI setting air ventilation mode.

To ventilate the seat, press the  button. The indicator (blue) next to the button will come on. The air ventilation system has four settings:

- HI – Three indicators on.
- MID – Two indicators on.
- LO – One indicator on.
- OFF – All indicators off.

Pressing the  button while the air ventilation is running will switch the system to the HI setting heater mode.

Follow these precautions whenever you use the seat heaters and the seat ventilation:

- If the engine is left idling for an extended period, do not use the seat heaters, even on the LO setting. It can weaken the battery, causing hard starting.

Power Windows

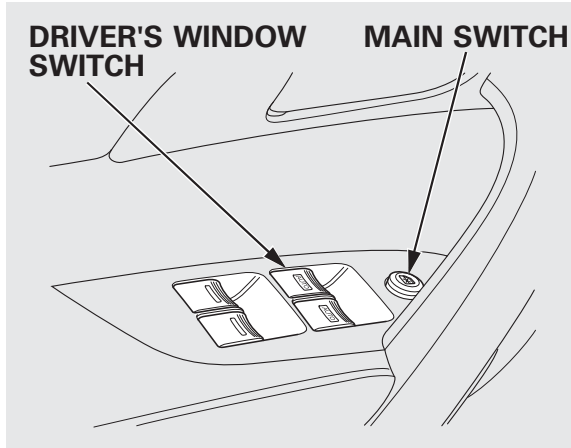

Turn the ignition switch to the ON (II) position to raise or lower any window. To open a window, push the switch down and hold it. Release the switch when you want the window to stop. Pull back on the switch and hold it to close the window.

The windows will operate for up to 10 minutes after you turn off the ignition switch. Opening either front door cancels this function.

⚠ WARNING

Closing a power window on someone's hands or fingers can cause serious injury.

Make sure your passengers are away from the windows before closing them.

AUTO – To open either front window fully, push the window switch firmly down to the second detent, then release it. The window automatically goes down all the way. To stop the window from going all the way down, pull back on the window switch briefly.

To close either front window fully, pull back the window switch firmly to the second detent, then release it. The window automatically goes all the way up. To stop the window from going all the way up, push down on the window switch briefly.

When you push the MAIN switch in, the switch is off, and the passengers' windows cannot be raised or lowered. To cancel this feature, push on the switch again to get it to pop out. Keep the MAIN switch pushed in when you have children in the vehicle so they do not injure themselves by operating the windows unintentionally.

AUTO REVERSE – If either front window senses any obstacle while it is closing automatically, it will reverse direction and then stop. To close the window, remove the obstacle, then use the window switch again.

Auto reverse stops sensing when the window is almost closed. You should always check that all passengers and objects are away from the window before closing it.

If your vehicle's battery is disconnected or goes dead, or the driver's window fuse is removed, the AUTO function may be disabled. If the AUTO function is disabled, the power window system will need to be reset after reconnecting the battery or installing the fuse.

1. Start the engine. Push down and hold the driver's window switch until the window is fully open.
2. Pull and hold the driver's window switch to close the window completely, then hold the switch for about 2 seconds.

If the power windows do not operate properly after resetting, have your vehicle checked by your dealer.

Opening the Windows and Moonroof with the Remote Transmitter

You can open all of the windows and the moonroof from outside with the remote transmitter.

1. Press the UNLOCK button once to unlock the driver's door.
2. Press the UNLOCK button a second time, and hold it. All the doors unlock, and all four windows and moonroof start to open. To stop the windows and moonroof, release the button.
3. To open the windows and moonroof further, press the button again (within 10 seconds of step 1) and hold it. If the windows and the moonroof stop before the desired position, repeat steps 1 and 2.

You cannot close the windows or the moonroof with the remote transmitter.

CONTINUED

Power Windows

Opening/Closing the Windows and Moonroof with the Key

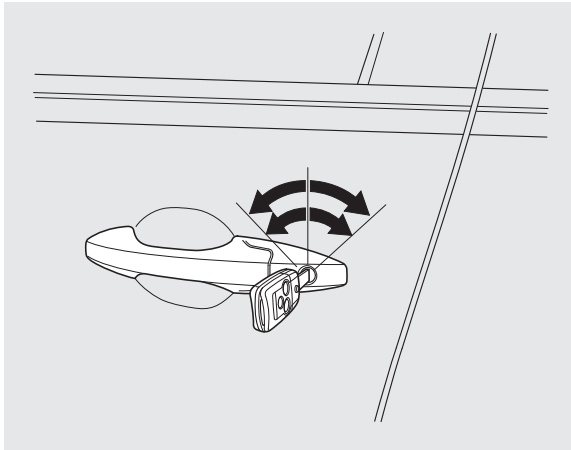

You can open and close the windows and moonroof with the key in the driver's door lock.

To open:

1. Insert the key in the driver's door lock.
2. Turn the key clockwise, then release it.

3. Turn the key clockwise again, and hold it. All four windows and the moonroof start to open. To stop the windows and the moonroof, release the key.
4. To open the windows and the moonroof further, turn and hold the key again (within 10 seconds of step 2).

To close:

1. Insert the key in the driver's door lock.
2. Turn the key counterclockwise, then release it.
3. Turn the key counterclockwise again, and hold it. All four windows and the moonroof start to close. To stop the windows and the moonroof, release the key.

4. To close the windows and the moonroof further, turn and hold the key again (within 10 seconds of step 2).

Auto reverse does not work when closing the windows and moonroof with the key.

NOTE: If the windows and the moonroof stop before the desired position, repeat steps 2 and 3.

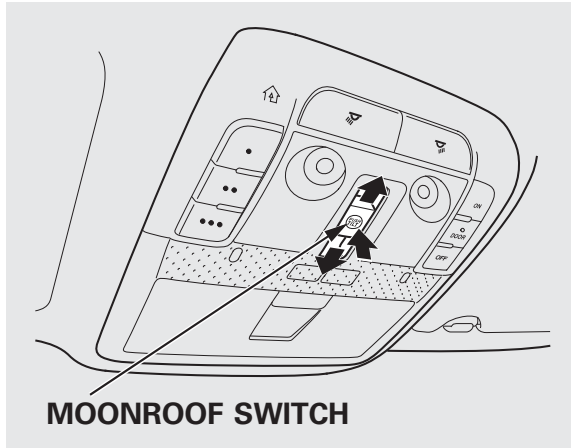

To open the moonroof fully, pull back the moonroof switch firmly. The moonroof opens all the way. To stop the moonroof from opening fully, push the switch briefly.

To tilt up the moonroof, push the center of the moonroof switch straight up. To stop the moonroof from tilting up fully, push the moonroof switch forward.

To close the moonroof fully, push the moonroof switch forward to the second detent, then release it. The moonroof closes all the way. To stop the moonroof from closing all the way, push the switch briefly.

To open or close the moonroof partially, pull back or push forward on the moonroof switch lightly to the first detent and hold it. The moonroof will stop when you release the switch.

Auto Reverse

If the moonroof runs into any obstacle while it is closing automatically, it will reverse direction, and then stop. To close the moonroof, remove the obstacle, then use the moonroof switch again.

Auto reverse stops sensing when the moonroof is almost closed. You should always check that all passengers and objects are away from the moonroof before closing it.

⚠ WARNING

Opening or closing the moonroof on someone's hands or fingers can cause serious injury.

Make sure all hands and fingers are clear of the moonroof before opening or closing it.

CONTINUED

Moonroof, Parking Brake

You can open and close the moonroof for up to 10 minutes after you turn off the ignition switch. Opening either front door cancels this function.

NOTICE

If you try to open the moonroof in below-freezing temperatures, or when it is covered with snow or ice, you can damage the moonroof panel or its motor.

Parking Brake

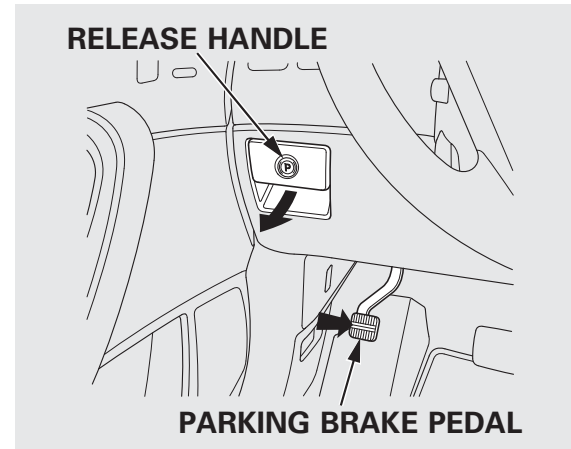

To apply the parking brake, push the pedal down with your foot. To release it, pull the release handle fully. The parking brake indicator on the instrument panel should go out when the parking brake is fully released (see page 69).

You will also see a “RELEASE PARKING BRAKE” message on the multi-information display (see page 87).

NOTICE

Driving the vehicle with the parking brake applied can damage the rear brakes and axles. A beeper will sound if the vehicle is driven with the parking brake on.

Keep the inside and outside mirrors clean and adjusted for best visibility. Be sure to adjust the mirrors before you start driving.

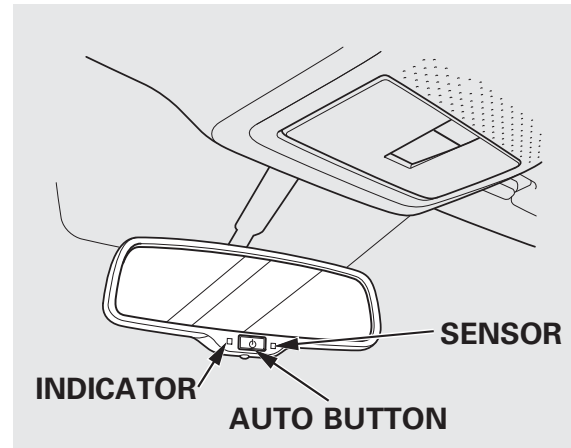

The inside mirror can automatically darken to reduce glare. To turn on this feature, press the button on the bottom of the mirror. The AUTO indicator comes on as a reminder. When it is on, the mirror darkens when it senses the headlights of a vehicle behind you, then returns to normal visibility when the lights are gone. Press the button again to turn off this feature.

NOTICE

There is also a sensor on the back of the mirror. Items hung on the mirror may block this sensor and affect its performance.

CONTINUED

Mirrors

Adjusting the Power Mirrors

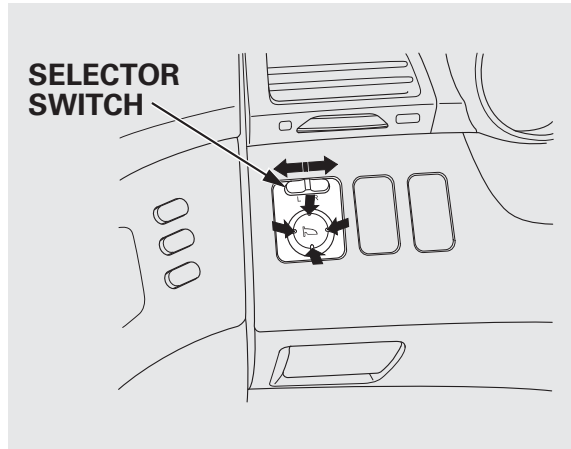

1. Turn the ignition switch to the ON (II) position.
2. Move the selector switch to L (driver's side) or R (passenger's side).

3. Push the appropriate edge of the adjustment switch to move the mirror right, left, up, or down.
4. When you finish, move the selector switch to the center (off) position. This turns the adjustment switch off to keep your settings.

Reverse Tilt Door Mirror

Both outside door mirrors have a reverse tilt feature. When in reverse, the selected mirror will tilt down slightly to improve your view as you parallel park. Shifting out of reverse will return the mirror to its original position.

- To tilt the driver's mirror, place the selector switch in the left position.
- To tilt the passenger's mirror, place the switch in the right position.
- To turn the feature off, place the switch in the center position.

Outside mirror positions can be stored in the driving position memory system (see page 168).

Heated Mirrors

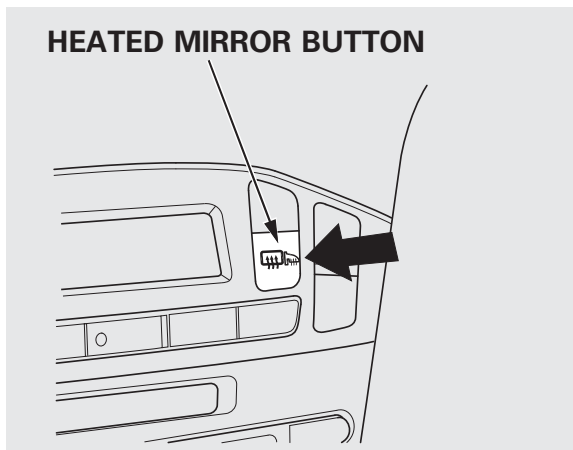

The outside mirrors are heated to remove fog and frost. With the ignition switch in the ON (II) position, turn on the heaters by pressing the button. The indicator in the button comes on as a reminder. Press the button again to turn the heaters off. Pressing this button also turns the rear window defogger on and off.

This heated mirror function has a timer (see page 132).

If the outside temperature is below 41°F (5°C), the heated mirror function will come on automatically for 10 minutes when you turn the ignition switch to the ON (II) position.

Folding Door Mirrors

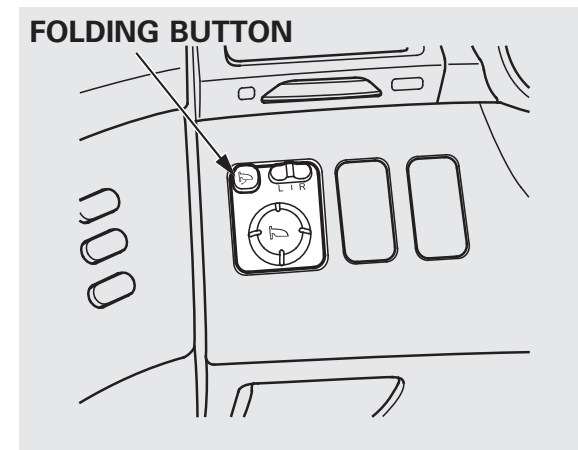

Canadian Elite Package model
Door mirrors can be folded by the folding button next to the selector switch, which enables you to park your vehicle in a limited parking space easily. Make sure you fold out the mirrors before you start driving. With the ignition switch in the ON (II) position, press the folding button to fold up both outside mirrors simultaneously. To fold out, press the button again.

CONTINUED

Mirrors, Driving Position Memory System

Never drive your vehicle with the outside mirrors folded.

Driving Position Memory System
Your vehicle has a memory feature for the steering wheel, driver's seat, and outside mirror positions.

Seat, except for power lumbar, steering wheel and outside mirror positions can be stored in separate memories. You select a memorized position by pushing the appropriate button or using the appropriate remote transmitter (Driver 1 or Driver 2). For more information see page 148.

Storing a Driving Position in Memory

Store a driving position only when the vehicle is parked.

1. Turn the ignition switch to the ON (II) position. You cannot add a new driving position to the memory unless the ignition switch is in the ON (II) position. You can recall a memorized position with the ignition switch in any position.
2. Adjust the seat to a comfortable position (see page 149).
Adjust the steering wheel to a comfortable position (see page 134).
Adjust the outside mirrors for best visibility (see page 166).

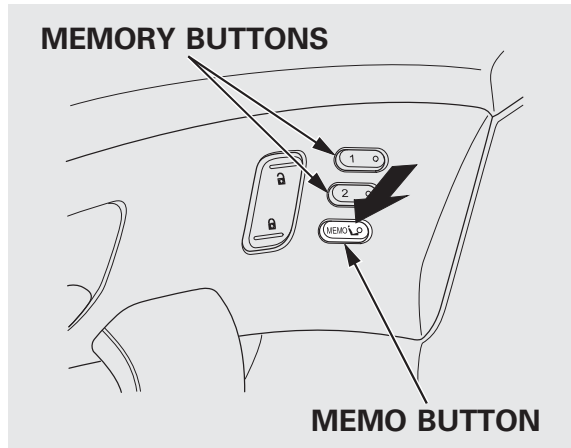

3. Press and release the MEMO button on the control panel. You will hear a beep. Immediately press and hold one of the memory buttons (1 or 2) until you hear two beeps. The indicator in the memory button will come on. The current positions of the driver's seat, steering wheel, and outside mirrors are now stored.

Doing any of the following after pressing the MEMO button will cancel the storing procedure.

- Not pressing a memory button within 5 seconds.
- Readjusting the seat position.
- Readjusting the outside mirror position.

Each memory button stores only one driving position. Storing a new position erases the previous setting stored in that button's memory. If you want to add a new position while retaining the current one, use the other memory button.

Selecting a Memorized Position
To select a memorized position, do this:

1. Make sure the vehicle is parked.
2. Press the desired memory button (1 or 2) until you hear a beep, then release the button.

The system will move the seat, steering wheel, and outside mirrors to the memorized positions. The indicator in the selected memory button will flash during movement. When the adjustments are complete, you will hear two beeps, and the indicator will remain on.

To change the “MEMORY POSITION LINK” setting, see page 108.

CONTINUED

Driving Position Memory System, Interior Lights

To stop the system's automatic adjustment, do any of these actions:

- Press any button on the control panel: MEMO, 1, or 2.
- Push any of the adjustment switches for the seat.
- Shift out of Park.
- Adjust the outside mirrors.

If desired, you can use the adjustment switches to change the positions of the seat, steering wheel or outside mirrors after they are in their memorized position. If you change the memorized position, the indicator in the memory button will go out. To keep this driving position for later use, you must store it in the driving position memory.

Light Control Buttons

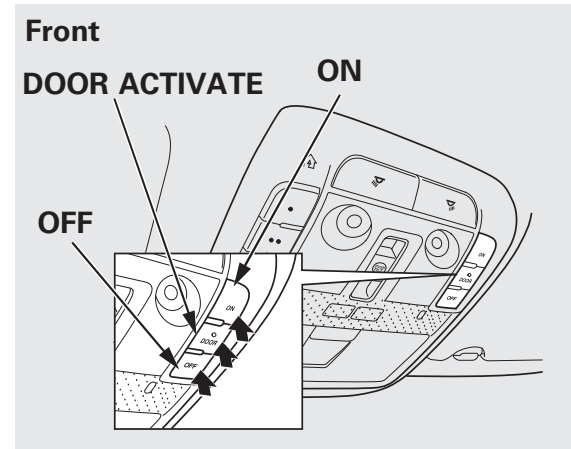

Your vehicle has the light control buttons on the front ceiling. With these buttons, you can select three positions: OFF, Door (door activated position), and ON. To select a position, press the appropriate button.

When you press the DOOR button, the green indicator in the button comes on as a reminder.

To turn off the setting, press the OFF button.

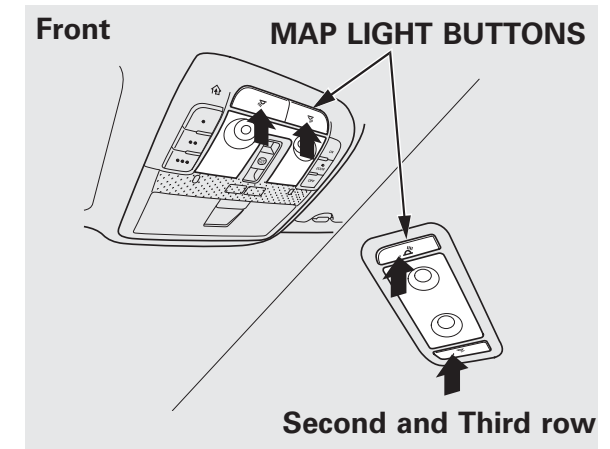

OFF position:

- The front individual map lights can be turned on and off by pressing each map light button (☹).
- The second and third row individual map lights cannot be turned on.

Door (Door activated position):

- The individual map lights in the front, second and third row come on when any door is opened, when the remote transmitter is used to unlock the doors (see page 145). When the doors are closed, each light can be turned on and off by pushing the map light button (☞).

After all doors are closed tightly, the lights dim slightly, then fade out in about 30 seconds.

To change the “INTERIOR LIGHT DIMMING TIME” setting, see page 111.

ON position:

- All the individual map lights come on and stay on.

Individual Map Lights

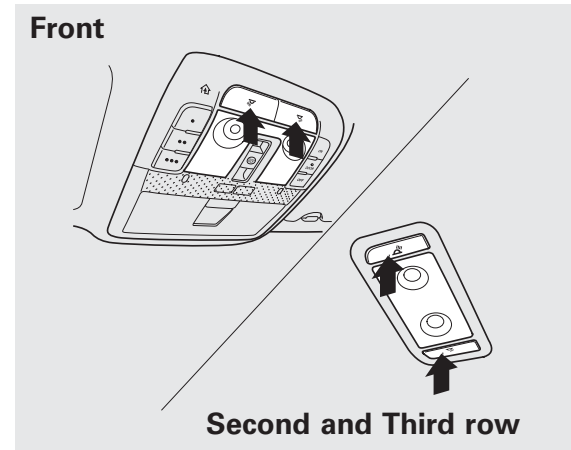

Turn on the front individual map lights by pushing each map light button (☞). Push the button again to turn it off. When the door activated position is selected with the light control button, the second and the third row map lights can be turned on by pushing each map light button (☞). Push the button again to turn it off.

If any map light is left on when the ignition switch is turned off and all doors are closed, it will turn off when the vehicle is locked with the remote transmitter, or after 15 minutes.

CONTINUED

Interior Lights

Courtesy Lights

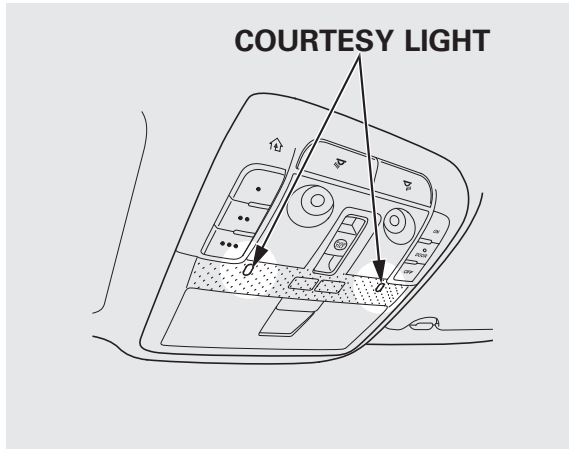

The courtesy lights between the front map lights come on when the parking lights are turned on. To adjust its brightness, press either of the instrument panel brightness control buttons (+ or -) with the ignition switch in the ON (II) position.

Tailgate Lights

The lights in the tailgate have an on-off switch to control if the lights come on when the tailgate is opened. The tailgate lights do not come on when any other doors are opened.

Individual Interior Lights

The courtesy lights in all four doors come on when you open any door. The light around the ignition switch comes on when any door is opened. After you close the door, the ignition switch light stays on for about 30 seconds regardless of the interior light dimming time setting (see page 111).

Interior Convenience Items

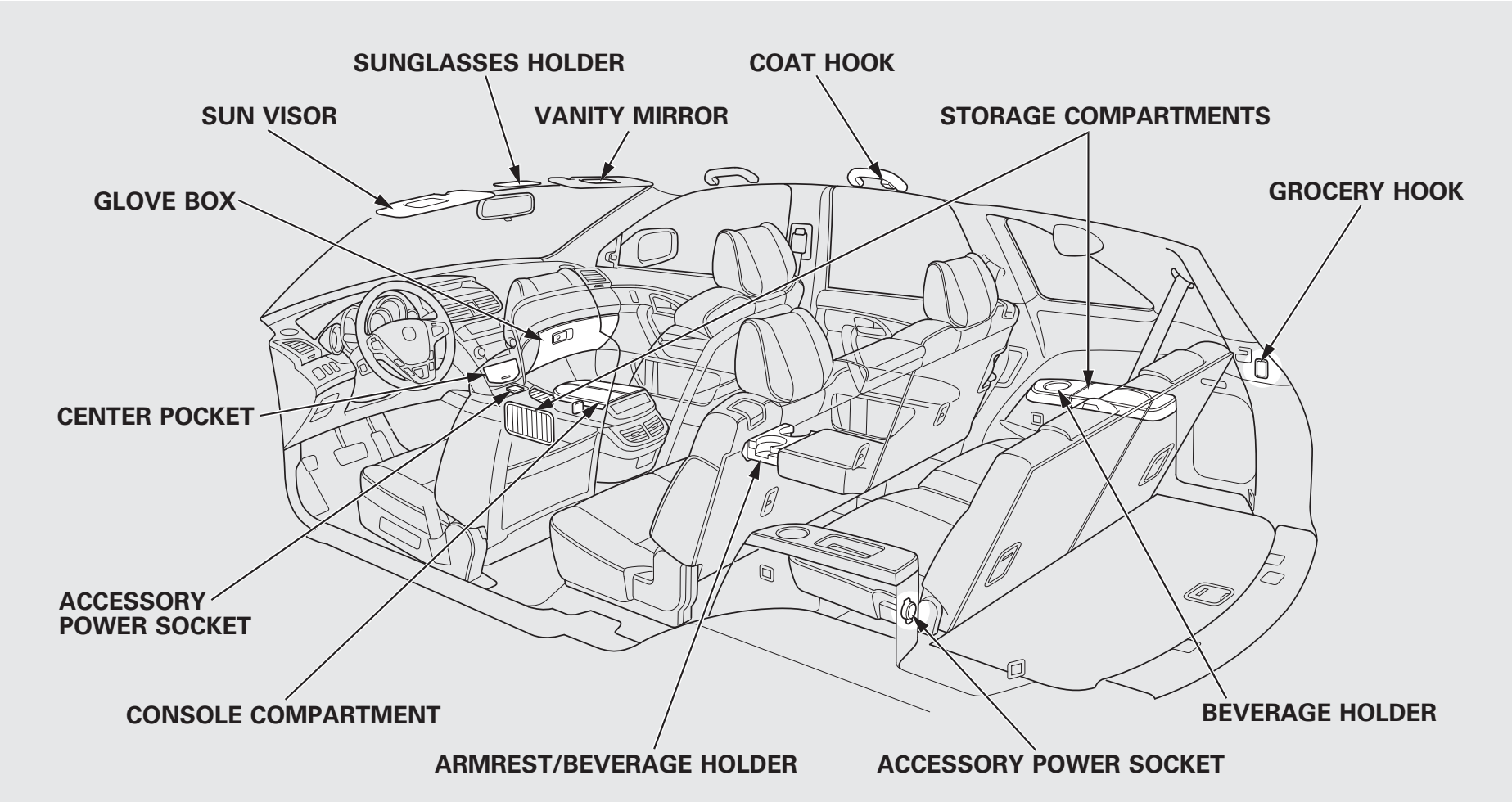

Interior Convenience Items

Beverage Holders

Be careful when you are using the beverage holders. A spilled liquid that is very hot can scald you or your passengers. Liquid can also spill from the door pocket beverage holders when you open or close the doors. Use only resealable containers in the door pockets.

Spilled liquids can damage the upholstery, carpeting, and electrical components in the interior.

Open the front beverage holder by sliding the lid.

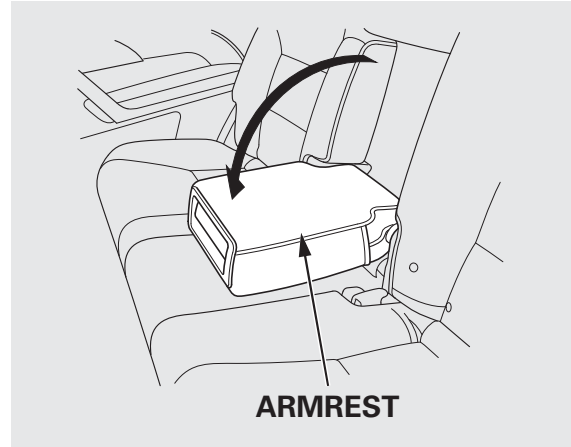

Beverage holders are also provided in the second row seat armrest. Pivot down the seat-back to use them.

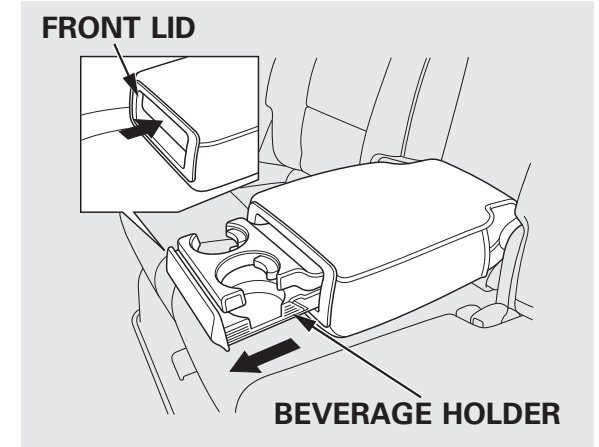

To open the beverage holder, press and release the front lid. To close, press the lid again until it latches. When you put back the armrest in the center seat-back, make sure the lid is closed properly.

Console Compartment

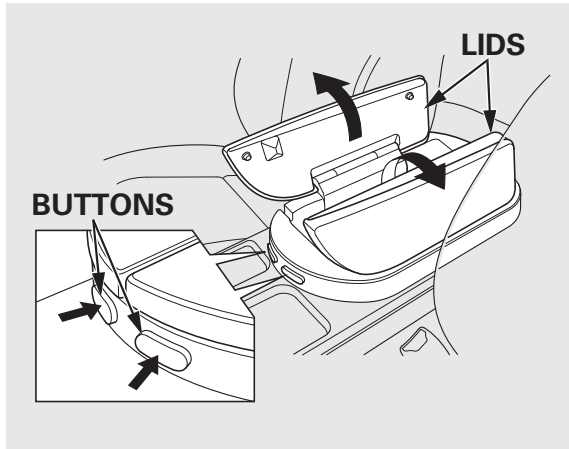

Your vehicle is equipped with a front seat armrest pad that is also a console compartment. To open the console compartment fully, push both buttons at the front of the compartment.

The console compartment has a removable tray. Pull the tray straight up to remove it.

Storage Compartment

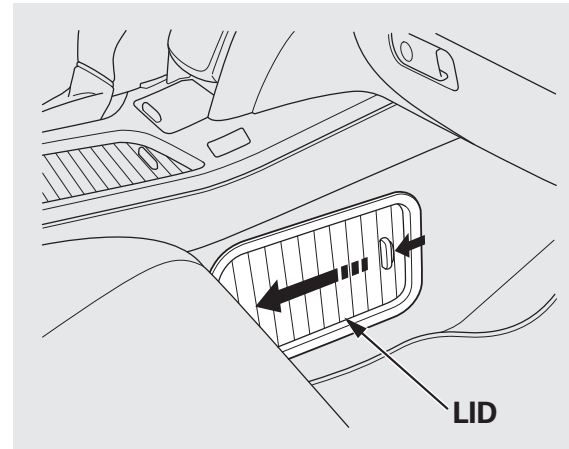

The storage compartment with a sliding lid is at the left-side foot of the front passenger seat.

For the third row, a storage compartment is located in the passenger side armrest. To open the compartment, push the button and lift the lid.

Glove Box

Open the glove box by pulling the handle to the left. Close it with a firm push. Lock or unlock the glove box with the master key.

⚠ WARNING

An open glove box can cause serious injury to your passenger in a crash, even if the passenger is wearing the seat belt.

Always keep the glove box closed while driving.

Interior Convenience Items

Sunglasses Holder

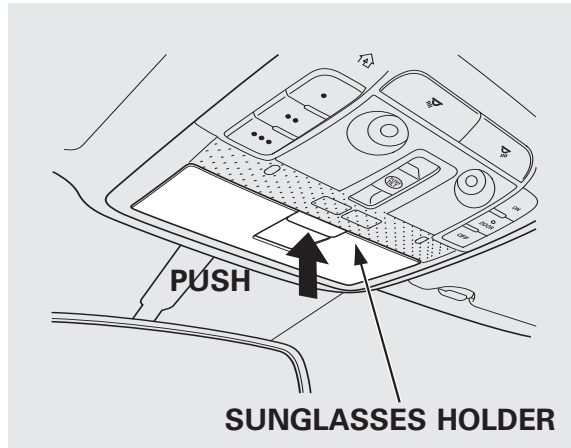

To open the sunglasses holder, push on the lid. It will unlatch and swing down. To close it, push it until it latches. Make sure the holder is closed while you are driving.

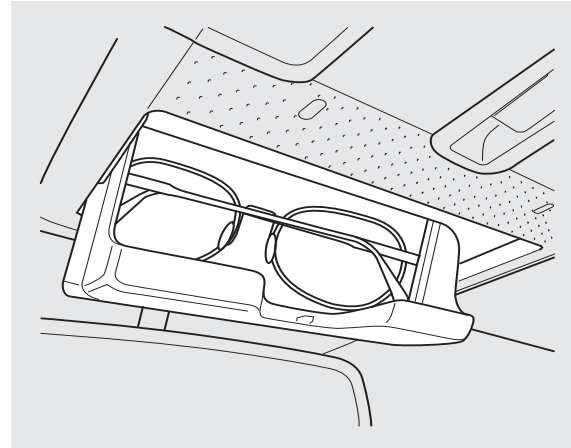

Some larger styles of sunglasses may not fit in the holder.

You may also store small items in this holder. Make sure they are small enough to let the holder close and latch, and that they are not heavy enough to cause the holder to pop open while driving.

Sun Visor

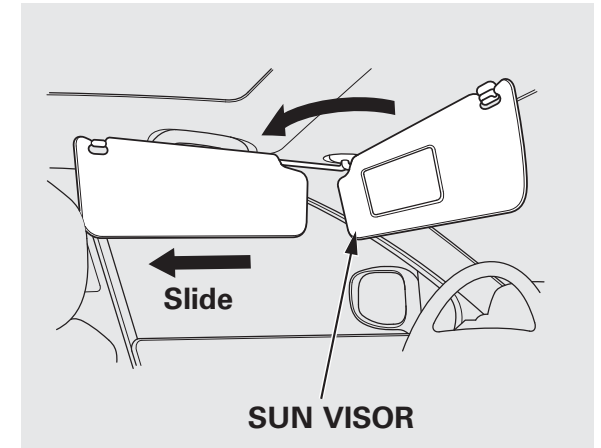

To use the sun visor, pull it down. When using the sun visor for the side window, remove the support rod from the clip, and swing it out. In this position, the sun visor can be adjusted by moving it on its slider. Do not use the extended sun visor over the inside mirror.

Make sure you put the sun visor back in place when you are getting into or out of the vehicle.

Vanity Mirror

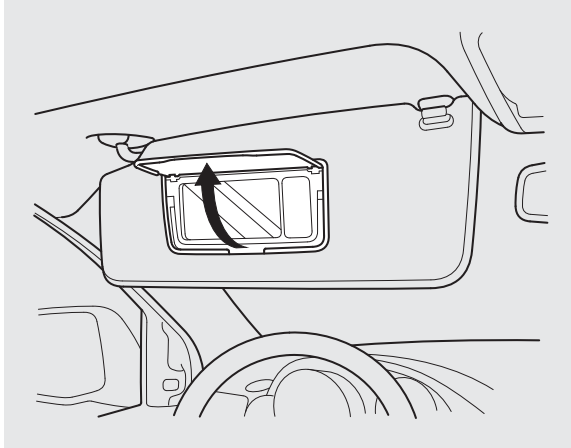

To use the vanity mirror on the back of the sun visor, pull up the cover.

The vanity mirror light will not come on if the sun visor is slid outward.

Accessory Power Sockets

Your vehicle has two or three accessory power sockets, depending on the model. All models have the front accessory power socket under the audio system and rear socket behind the third row seat on the driver's side.

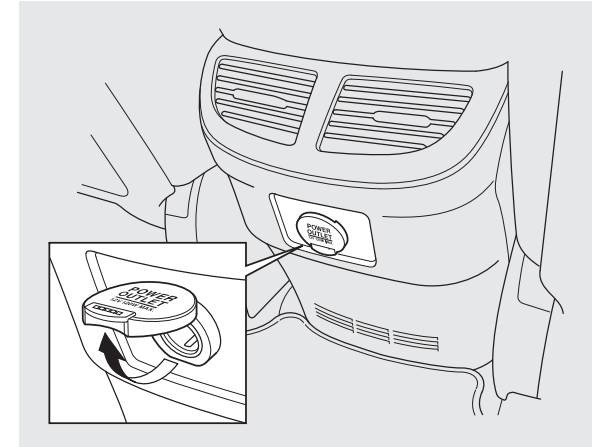

On models without rear entertainment system

The accessory power socket is located at the back of the front console compartment.

To use an accessory power socket, the ignition switch must be in the ACCESSORY (I) or ON (II) position.

CONTINUED

Interior Convenience Items

Each socket is intended to supply power for 12 volt DC accessories that are rated 120 watts or less (10 amps).

None of the sockets will power an automotive type cigarette lighter element.

AC Power Outlet

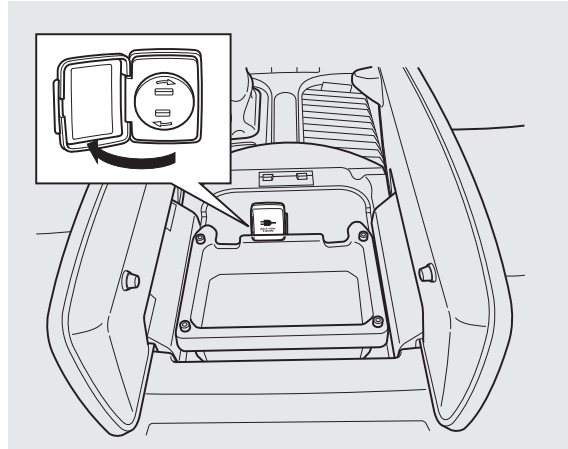

On models with rear entertainment system

There is a 115 volt AC power outlet inside the front console compartment. To use the AC power outlet, open the lids and open the outlet cover. Insert the plug into the receptacle slightly, turn it 90° clockwise, then push in the plug all the way.

Always run the engine when you use the AC power outlet.

The maximum capacity for this power outlet is 115 volt AC at 100 watts or less. If you use an appliance which requires more than 100 watts, it automatically stops supplying the power. If this happens, turn the ignition switch off and turn it on again.

NOTE: The AC power outlet is not designed for electric appliances which require high initial peak wattage such as cathode-ray tube type televisions, refrigerators, electric pumps, etc. It is also not suitable for devices that process precise data such as medical equipment or measuring instruments. Any appliances that require an extremely stable power supply such as microcomputer-controlled electric blankets, touch sensor lamps, etc., should not be connected to this outlet.

The climate control system in your vehicle provides a comfortable driving environment in all weather conditions.

The standard audio system has many features. This section describes those features and how to use them.

Your vehicle has an anti-theft audio system that requires a code number to enable it.

The security system helps do discourage vandalism and theft to your vehicle.

Climate Control System	182
Rear Climate Controls.....	187
Audio System.....	192
Playing the AM/FM Radio (Models without navigation system)	193
Playing the XM® Radio (Models without navigation system)	197
Playing Discs (Models without navigation system)	203

Disc Changer Error Message (Models without navigation system)	211
Audio System (Models with navigation system)	212
Playing the AM/FM Radio (Models with navigation system)	213
Playing the XM® Radio (Models with navigation system)	226
Playing a Disc (Models with navigation system)	235
Disc Player Error Messages (Models with navigation system)	246
Protecting Your Discs.....	247
Playing Hard Disc Drive (HDD) Audio (Models with navigation system)	250
Playing an iPod® (Models with navigation system)	278
iPod® Error Messages (Models with navigation system)	286
Playing a USB Flash Memory Device (Models with navigation system)	287

USB Flash Memory Device Error Messages (Models with navigation system)	297
Bluetooth® Audio System (Models with navigation system)	298
AM/FM Radio Reception.....	303
Remote Audio Controls.....	305
Auxiliary Input Jack	307
Radio Theft Protection	308
Setting the Clock and Calendar	309
Rear Entertainment System.....	310
Security System.....	341
Compass.....	342
Cruise Control.....	345
Adaptive Cruise Control (ACC)	348
HomeLink® Universal Transceiver	363
Bluetooth® HandsFreeLink® (Models without navigation system)	365
Bluetooth® HandsFreeLink® (Models with navigation system)	383
AcuraLink® (U.S. models only)	402
Rearview Mirror with Rearview Camera Display	417

Climate Control System

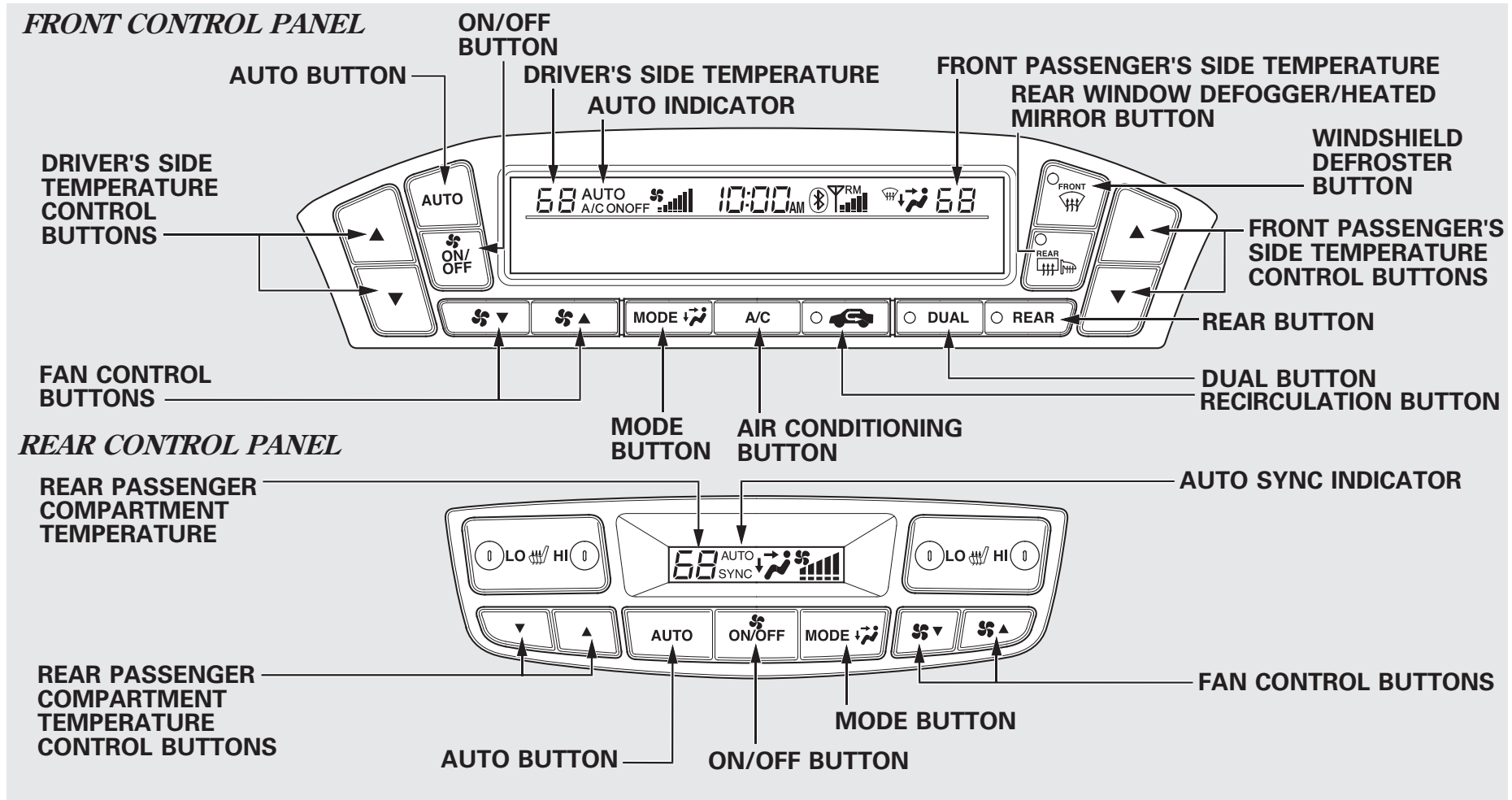

Personalization Setting

When you unlock the doors with your remote, the driver's ID (Driver 1 or Driver 2) is detected, and the climate control settings are turned to the respective mode automatically when the ignition is turned to the ON (II) position.

Voice Control System

On models with navigation system

The climate control system can also be operated by voice control. See the navigation system manual for complete details.

Using Automatic Climate Control

The automatic climate control system in your vehicle picks the proper combination of air conditioning, heating, and ventilation to maintain the interior temperature you select, and to remove moisture from the air and make the interior dry. The system also adjusts the fan speed and airflow levels.

1. Press the Auto button on the front control panel.
2. Set the desired temperature with the temperature control buttons. You will see AUTO in the system's display.
3. You can set the driver's side temperature, the passenger's side temperature, and the temperature of the rear passenger compartment separately.

The system automatically selects the proper mix of conditioned and/or heated air that will, as quickly as possible, raise or lower the interior temperature to your preference.

Temperature Control

The driver's side temperature, the passenger's side temperature and the rear passenger compartment temperature can be set separately. Press the ▲ button of the appropriate temperature control to increase the temperature of airflow. Press the ▼ button to decrease it. Each set temperature is shown in the display. The rear temperature is shown in the display on the back of the center console.

CONTINUED

Climate Control System

When you set the temperature to its lower limit (L) or its upper limit (H), the system runs at full cooling or heating only. It does not regulate the interior temperature.

When you press a fan control button, the fan is taken out of AUTO mode.

When the indicator in the dual button is on, the driver's side and passenger's side temperature can be controlled independently (see page 189).

When the indicator in the rear button is on, the temperature of the rear passenger compartment can be controlled independently (see page 189).

On models with navigation system

In the Auto mode, the vehicle's interior temperature is independently regulated for the driver, front passenger, and rear passengers according to each adjusted temperature. The system also regulates each temperature based on the information of the sun light sensor and the sun's position which is updated automatically by the navigation's global positioning system (GPS). For example, if the driver's side of the vehicle is getting too much sun, the system will adjust to a lower temperature.

Dual Button

You can set the temperatures for the driver's side and the passenger's side separately when this button is pressed (indicator is on). When the indicator in the DUAL button is off, the temperatures for both sides are synchronized to the driver's side set temperature. When defrost mode is selected, dual mode operation is canceled.

Rear Button

When you press this button, the indicator in the button comes on, and the temperature of the rear passenger compartment can be adjusted separately with the temperature control buttons on the back of the center console. With the indicator off, the temperature of the rear passenger compartment is synchronized to the driver's side set temperature. You will see the AUTO SYNC on the system display of the rear control panel. Changing the temperature of the rear passenger compartment also makes the indicator turn on, and takes the system out of synchronized mode. This causes the word SYNC in the display to go out.

ON/OFF Button

Each time you press this button, the climate control system switches between on and off. Turning on the system with this button selects your last climate control selection.

To Turn Everything Off

If you press the ON/OFF button, the climate control system shuts off completely.

- Keep the system completely off for short periods only.
- To keep stale air and mustiness from collecting, you should have the fan running at all times.

Semi-automatic Operation

You can manually select various functions of the climate control system when it is in fully automatic mode. All other features remain automatically controlled. Making any manual selection causes the word AUTO in the display to go out.

Fan Control

Press the  ▲ button to increase the fan speed and airflow. Press the  ▼ button to decrease it.

Air Conditioning (A/C) Button

This button turns the air conditioning on and off. You will see A/C ON or A/C OFF in the display.

When you turn the A/C off, the system cannot regulate the inside temperature if you set the temperature control below the outside temperature.

CONTINUED

Climate Control System

Recirculation Button

When the indicator in the button is on, air from the vehicle's interior is sent throughout the system again. When the indicator is off, air is brought in from the outside of the vehicle (fresh air mode).

The outside air intakes for the climate control system are at the base of the windshield. Keep this area clear of leaves and other debris.

The system should be left in fresh air mode under almost all conditions. Keeping the system in recirculation mode, particularly with the A/C off, can cause the windows to fog up.

Switch to recirculation mode when driving through dusty or smoky conditions, then return to fresh air mode.

Rear Window Defogger Button

This button turns the rear window defogger on and off (see page 132).

Pushing this button also turns the power mirror heaters on and off.

Mode Control

Use the mode control button to select the vents the air flows from. Some air will flow from the dashboard vents in all modes.

 Air flows from the center and corner vents in the dashboard.

 Airflow is divided between the vents in the dashboard and the floor vents.

 Air flows from the floor vents.

 Airflow is divided between the floor and corner vents and the defroster vents at the base of the windshield.

Windshield Defroster Button

This button directs the main airflow to the windshield for faster defrosting. It also overrides any mode selection you may have made.

When you select , the system automatically switches to fresh air mode and turns on the A/C. For faster defrosting, manually set the fan speed to high. You can also increase airflow to the windshield by closing the corner vents on the dashboard. To close the vents, rotate the wheel under each corner vent.

When you turn off  by pressing the button again, the system returns to its former settings.

For your safety, make sure you have a clear view through all the windows before driving.

When the indicator in the button is on, the front passenger's and rear passenger compartment temperatures cannot be set separately from the driver's.

Rear Climate Controls

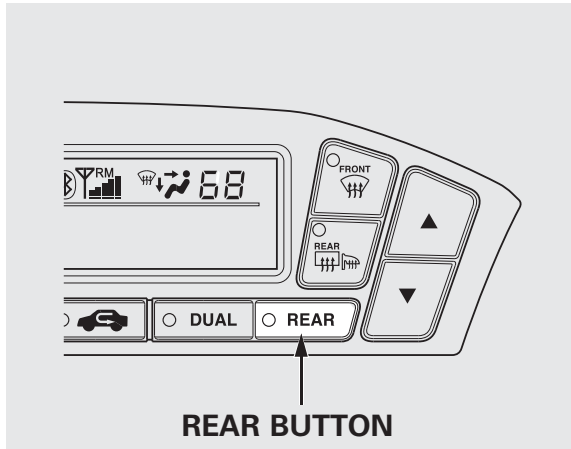

Rear Button

When the indicator in this button is off, the temperature of the rear passenger compartment is synchronized to the driver's side set temperature. If the AUTO mode is selected on the front control panel, you will see AUTO SYNC on the rear system display. When the indicator in this button is on, the temperature of the rear passenger compartment can be adjusted with the rear temperature control buttons. A passenger can also adjust the fan speed and airflow.

REAR CONTROL PANEL

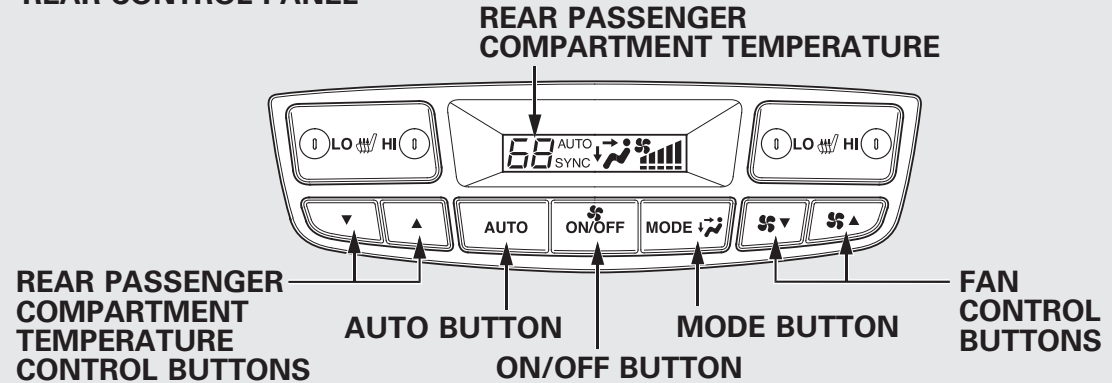

You can use the rear control panel when the indicator in the REAR button on the front control panel is on. Pressing any control button on the rear control panel turns on the rear button indicator on the front control panel.



CONTINUED

Climate Control System



Temperature Control

Press the ▲ temperature control button to increase the temperature of airflow, and the ▼ button to decrease it. The temperature you adjust is shown in the system display.

Fan Control

Press the  ▲ fan control button to increase the fan speed and airflow. Press the  ▼ button to decrease it. The level of the fan speed is shown in the display.

Mode Control

Each time you press the mode button, the mode display changes from  to .

When  is selected, air flows from the upper vents on the back of the center console.

When  is selected, air flows from the lower vents.

Automatic Operation

Pressing the AUTO button puts the system in automatic operation mode. The rear system automatically adjusts the fan speed and airflow levels to maintain the selected temperature of the rear passenger compartment. You will see AUTO in the display.

Pressing the ON/OFF button shuts off the rear climate control system.

Triple Zone Temperature Control

The temperatures of the driver's side and the front passenger's side can be controlled independently when the indicator in the DUAL button is on.

When the indicator in the REAR button is on, the temperature of the rear passenger compartment can be controlled independently.

To adjust each temperature, press either of the temperature control buttons (▲ or ▼) on the climate control panel.

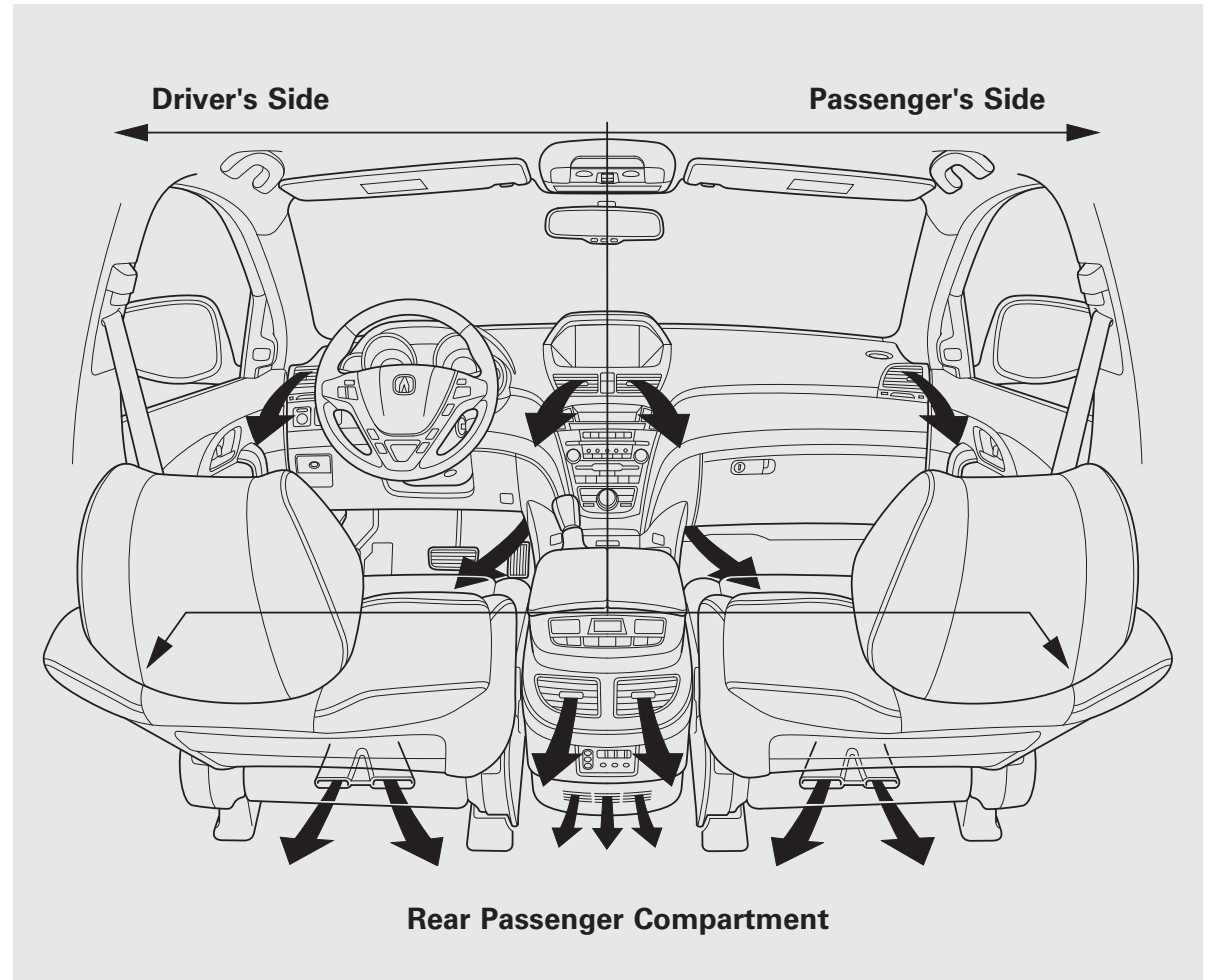

CONTINUED

Climate Control System

Push AUTO or . The selected temperatures appear in the display. When the indicator in the DUAL button is off, you can adjust both sides to the same temperature by adjusting the driver's temperature control buttons.

To set the driver's side temperature to a different value than the passenger's side, press the DUAL button, then press either of the driver's temperature control button (▲ or ▼). To set the passenger's side to a different value than the driver's side, press either of the front passenger's temperature control button (▲ or ▼). You can adjust the passenger's side without pressing the DUAL button first.

When the indicator in the REAR button is off, the temperature of the rear passenger compartment is synchronized to the driver's side set temperature. You will see AUTO SYNC on the system display of the rear control panel.

To set the temperature of the rear passenger compartment to a different value than the driver's side, press the REAR button, then press either temperature control buttons on the back of the center console. The word "SYNC" in the display goes out. You can also adjust the rear temperature without pressing the REAR button first. Pressing either button causes the indicator of the REAR button to turn on.

When you set each temperature to its lower limit or its upper limit, it will be displayed as "Hi" or "Lo".

Sunlight and Temperature Sensors

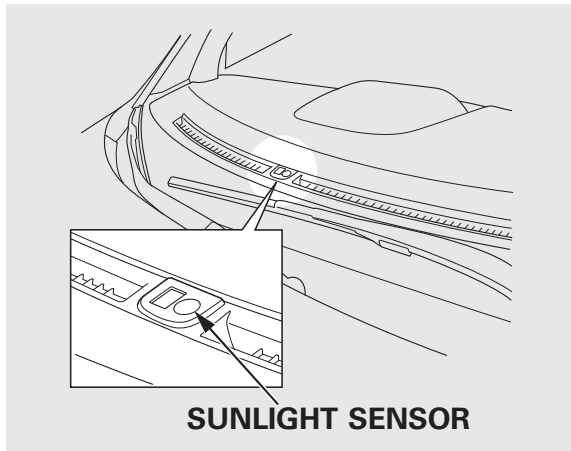

To regulate the interior temperature and humidity, the climate control system has two sensors. A sunlight sensor is located in the top of the dashboard and a temperature/humidity sensor is next to the steering column. Do not cover the sensors or spill any liquid on them.

TEMPERATURE/HUMIDITY SENSOR

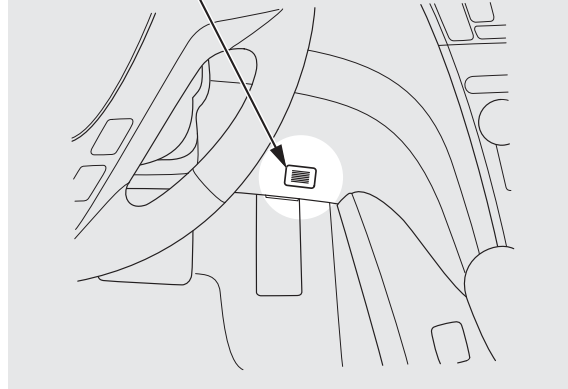

Audio System

An audio system is standard on all models. Read the appropriate pages (as shown below) to use your vehicle's audio system.

For vehicles without navigation system, see pages 193 through 211.

For vehicles with navigation system, see pages 212 through 302.

Personalization Setting

When you unlock the doors with your remote and turn the audio system on, the driver's ID (Driver 1 or Driver 2) is detected, and the radio presets and sound level settings (see page 196,) are turned to the respective memorized mode automatically.

Without navigation system

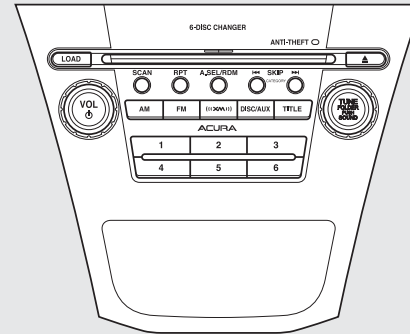

With navigation system

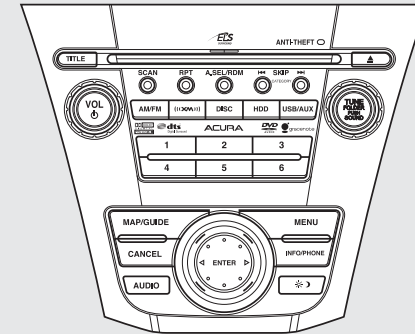

With rear entertainment system

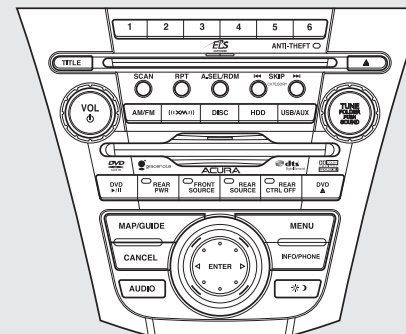

Playing the AM/FM Radio (Models without navigation system)

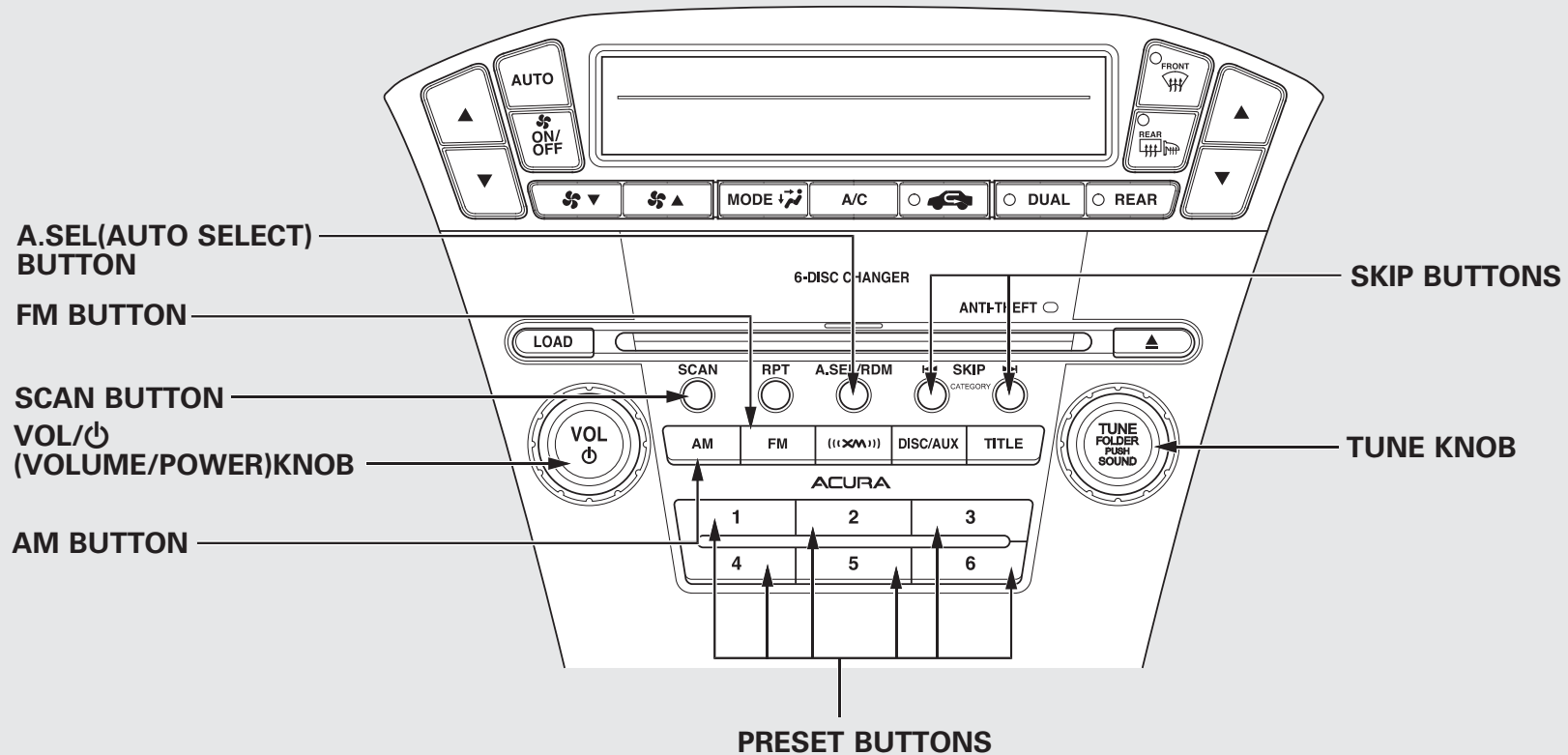

CONTINUED

Playing the AM/FM Radio (Models without navigation system)

To Play the Radio

The ignition switch must be in the ACCESSORY (I) or ON (II) position. Turn the system on by pushing the VOL/🔊 knob or the AM or FM button. Adjust the volume by turning the VOL/🔊 knob.

The band and frequency that the radio was last tuned to are displayed. To change bands, press the AM or FM button. On the FM band, ST will be displayed if the station is broadcasting in stereo. Stereo reproduction in AM is not available.

To Select a Station

You can use any of five methods to find radio stations on the selected band: tune, skip(seek), scan, the preset buttons, and auto select.

TUNE – Use the TUNE knob to tune the radio to a desired frequency. Turn the knob right to tune to a higher frequency, or left to tune to a lower frequency.

SKIP(SEEK) – The skip(seek) function searches up and down from the current frequency to find a station with a strong signal. To activate it, press and hold the ►► or ◄◄ side of the button, then release it.

SCAN – The scan function samples all stations with strong signals on the selected band. To activate it, press the SCAN button, then release it. You will see SCAN in the display. When the system finds a strong signal, it will stop and play that station for about 10 seconds.

If you do nothing, the system will scan for the next strong station and play it for 10 seconds. When it plays a station that you want to listen to, press the SCAN button again.

Playing the AM/FM Radio (Models without navigation system)

Preset – Each preset button can store one frequency on AM and two frequencies on FM.

1. Select the desired band, AM or FM. FM1 and FM2 let you store two frequencies with each preset button.
2. Use the tune, skip (seek), or scan function to tune the radio to a desired station.
3. Pick a preset button, then press and hold it until you hear a beep.
4. Repeat steps 1 through 3 to store a total of six stations on AM and twelve stations on FM.

AUTO SELECT – If you are traveling and can no longer receive your preset stations, you can use the auto select feature to find stations in the local area.

Press the A.SEL button. “A.SEL” flashes in the display, and the system goes into scan mode for several seconds. It stores the frequencies of six AM and twelve FM stations in the preset buttons.

You will see a “0” displayed after pressing a preset button if auto select cannot find a strong station for that preset button.

If you do not like the stations auto select has stored, you can store other frequencies on the preset buttons as previously described.

To turn off auto select, press the A.SEL (auto select) button. This restores the presets you originally set.

The presets may be lost if your vehicle's battery goes dead, is disconnected, or the radio fuse is removed.

For information on AM/FM radio frequencies and reception, see page 303.

CONTINUED

Playing the AM/FM Radio (Models without navigation system)

Adjusting the Sound

Press the TUNE (SOUND) knob repeatedly to display the BASS, TREBLE, FADER, BALANCE, SUBWOOFER, CENTER, and SVC (speed-sensitive volume compensation) settings.

BASS – Adjusts the bass.

TREBLE – Adjusts the treble.

FADER – Adjusts the front-to-back strength of the sound.

BALANCE – Adjusts the side-to-side strength of the sound.

SUBWOOFER – Adjusts the strength of sound from the subwoofer speaker.

CENTER – Adjusts the strength of sound from the center speaker.

SVC – Adjusts the volume level based on the vehicle speed.

Each mode is shown in the display as it changes. Turn the TUNE knob to adjust the setting to your liking. When the level reaches the center, you will see “C” in the display.

The system will return to the audio display about 5 seconds after you stop adjusting a mode.

Speed-sensitive Volume Compensation (SVC)

The SVC mode controls the volume based on vehicle speed. The faster you go, the louder the audio volume becomes. As you slow down, the audio volume decreases.

The SVC has four modes: SVC OFF, SVC LOW, SVC MID, and SVC HIGH. Turn the TUNE knob to adjust the setting to your liking. If you feel the sound is too loud, choose low. If you feel the sound is too quiet, choose high.

Audio System Lighting

You can use the instrument panel brightness control buttons to adjust the illumination of the audio system (see page 133). The audio system illuminates when the parking lights are on, even if the radio is off.

Playing the XM® Radio (Models without navigation system)

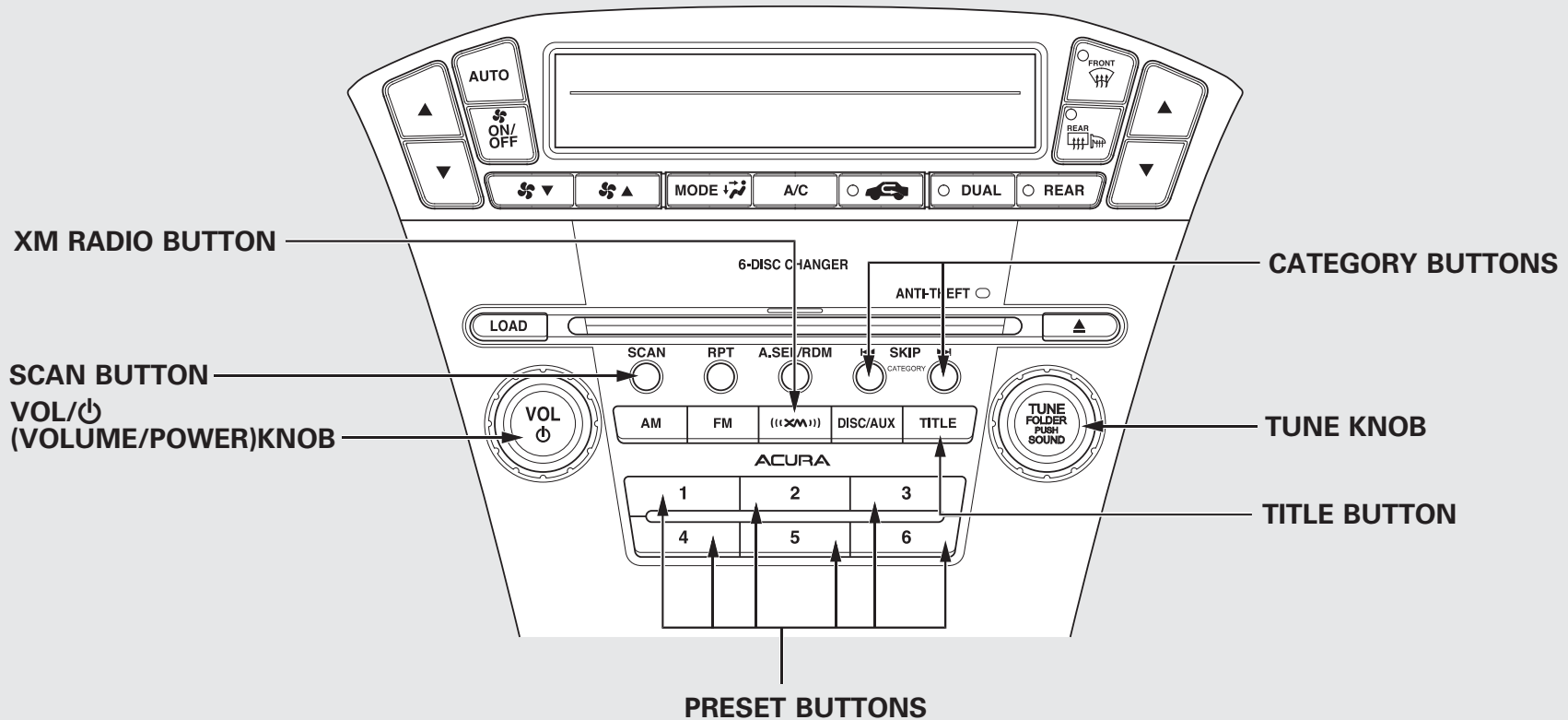

CONTINUED

Playing the XM® Radio (Models without navigation system)

Your vehicle is capable of receiving XM® Radio anywhere in the United States and Canada, except Hawaii, Alaska, and Puerto Rico.

XM is a registered trademark of Sirius XM Radio, Inc. and XM CANADA® is a registered business name of Canadian Satellite Radio Inc.

XM Radio receives signals from two satellites to produce clear, high-quality digital reception. It offers many channels in several categories. Along with a large selection of different types of music, XM Radio allows you to view channel and category selections in the display.

Operating the XM Radio

To listen to XM Radio, turn the ignition switch to the ACCESSORY (I) or ON (II) position. Push the VOL/⏻ knob to turn on the audio system, and press the («XM») button. The last channel you listened to will show in the display. Adjust the volume by turning the VOL/⏻ knob.

MODE – To switch between channel mode and category mode, press and hold the TITLE button until the mode changes.

In the channel mode, you can select all of the available channels. In the category mode, such as Jazz, Rock, Classical, etc., you can select all of the channels within that category.

Each time you press and release the TITLE button, the display changes in the following sequence: channel name, channel number, category, artist name, and song title.

You may experience periods when XM Radio does not transmit the artist's name and song title information. If this happens, there is nothing wrong with your system.

TUNE – Turn the TUNE knob to change channel selections. Turn the knob right for higher numbered channels and left for lower numbered channels. In the category mode, you can only select channels within that category.

CATEGORY (◀◀ or ▶▶) – Press either button to select another category.

Playing the XM® Radio (Models without navigation system)

SCAN – The SCAN function gives you a sampling of all channels while in the channel mode. In the category mode, only the stations within that category are scanned. To activate scan, press the SCAN button. The system plays each channel in numerical order for about 10 seconds, then selects the next channel. When you hear a channel you want to continue listening to, press the button again.

Preset – You can store up to 12 preset channels using the six preset buttons. Each button stores one channel from the XM1 band and one channel from the XM2 band.

To store a channel:

1. Press the («XM») button. Either XM1 or XM2 will show in the display.

2. Use the TUNE knob, the CATEGORY buttons, or the SCAN buttons to tune to a desired channel.

In category mode, only channels within that category can be selected. In channel mode, all channels can be selected.

3. Pick the preset button you want for that channel. Press and hold the button until you hear a beep.
4. Repeat steps 2 and 3 to store the first six channels.
5. Press the («XM») button again. The other XM band will show. Store the next six channels using steps 2 and 3.

Once a channel is stored, simply press and release the proper preset button to tune to it.

The presets may be lost if your vehicle's battery goes dead, is disconnected, or the radio fuse is removed.

XM Radio Display Messages

“LOADING” – XM is loading the audio or program information.

“OFF AIR” – The channel currently selected is no longer broadcasting.

“UPDATING” – The encryption code is being updated. Wait until the encryption code is fully updated. Channels 0 and 1 should still work normally.

CONTINUED

Playing the XM® Radio (Models without navigation system)

“NO SIGNAL” – The signal is currently too weak. Move the vehicle to an area away from tall buildings, and with an unobstructed view of the southern horizon.

“ ” – The selected channel number does not exist, or is not part of your subscription, or this channel has no artist or title information at this time.

“ANTENNA” – There is a problem with the XM antenna. Please consult your dealer.

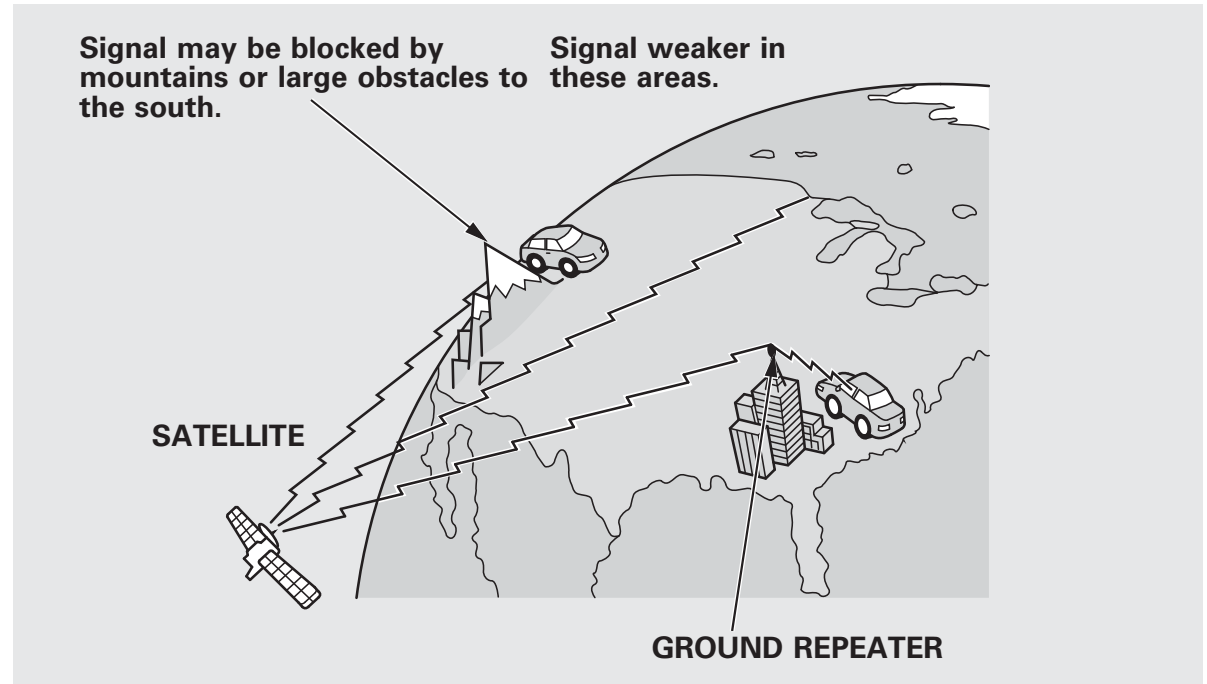

The XM satellites are in orbit over the equator; therefore, objects south of the vehicle may cause satellite reception interruptions. To help compensate for this, ground-based repeaters are placed in major metropolitan areas.

Satellite signals are more likely to be blocked by tall buildings and mountains the farther north you travel from the equator. Carrying large items on a roof rack can also block the signal.

Playing the XM® Radio (Models without navigation system)

Depending on where you drive, you may experience reception problems. Interference can be caused by any of these conditions:

- Driving on the north side of an east/west mountain road.
- Driving on the north side of a large commercial truck on an east/west road.
- Driving in tunnels.
- Driving on a road beside a vertical wall, steep cliff, or hill to the south of you.
- Driving on the lower level of a multi-tiered road.
- Driving on a single lane road alongside dense trees taller than 50 ft. (15 m) to the south of you.
- Large items carried on a roof rack.

There may be other geographic situations that could affect XM Radio reception.

*As required by the FCC:
Changes or modifications not expressly approved by the party responsible for compliance could void the user's authority to operate the equipment.*

This Category II radiocommunication device complies with Industry Canada Standard RSS-310.

Operation is subject to the following two conditions: (1) this device may not cause interference, and (2) this device must accept any interference, including interference that may cause undesired operation of the device.

Receiving XM Radio Service

If your XM Radio service has expired or you purchased your vehicle from a previous owner, you can listen to a sampling of the broadcasts available on XM Radio. With the ignition switch in the ACCESSORY (I) or the ON (II) position, push the VOL/⏻ knob to turn on the audio system, and press the (« XM ») button. A variety of music types and styles will play.

If you decide to purchase XM Radio service, contact XM Radio at www.siriusxm.com, or at 1-800-852-9696. In Canada, contact XM CANADA® at www.xmradio.ca, or at 1-877-209-0079. You will need to give them your radio I.D. number and your credit card number. To get your radio I.D. number, press the (« XM ») button, then turn the selector knob until “CH 000” appears in the display. Your I.D. will appear in the displays.

After you've registered with XM Radio, keep your audio system in the XM Radio mode while you wait for activation. This should take about 30 minutes.

CONTINUED

Playing the XM® Radio (Models without navigation system)

While waiting for activation, make sure your vehicle remains in an open area with good reception. Once your audio system is activated, “CATEGORY” or “CHANNEL” will appear in the display, and you'll be able to listen to XM Radio broadcasts. XM Radio will continue to send an activation signal to your vehicle for at least 12 hours from the activation request. If the service has not been activated after 36 hours, contact XM® Radio. In Canada, contact XM CANADA®.

Playing Discs (Models without navigation system)

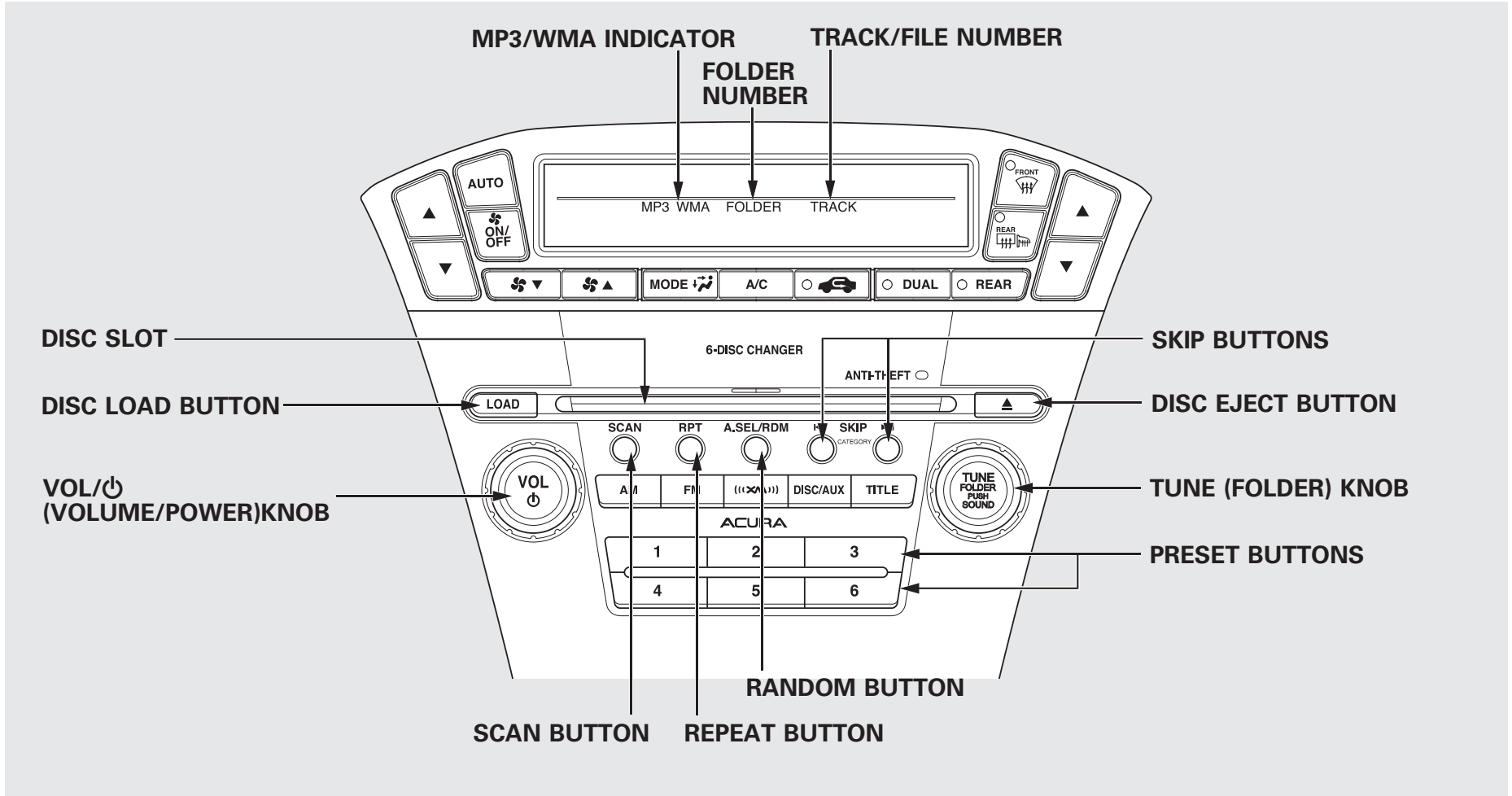

CONTINUED

Playing Discs (Models without navigation system)

To Play a Disc

To load or play discs, the ignition switch must be in the ACCESSORY (I) or ON (II) position.

You operate the disc changer with the same controls used for the radio. To select the disc changer, press the DISC button. You will see “DISC” in the display. The disc and track numbers, and the elapsed time are shown in the display. You can also select the displayed information with the TITLE button (see page 205). The system will continuously play a disc until you change modes.

NOTICE

Do not use discs with adhesive labels. The label can curl up and cause the disc to jam in the unit.

This audio system can also play CD-Rs and CD-RWs compressed in MP3 or WMA formats. When playing a disc in MP3, you will see “MP3” in the display. In WMA format, “WMA” will appear in the display. The disc, folder and track numbers are displayed. You can select up to 255 folders or tracks.

Video CDs and DVD discs do not work in this unit.

NOTE:

If a file on an MP3 or WMA disc is protected by digital rights management (DRM), the audio unit displays FORMAT, and then skips to the next file.

Depending on the software the files were made with, it may not be possible to play some files, or display some text data.

Playing Discs (Models without navigation system)

Loading Discs

Your vehicle's in-dash disc changer holds up to six discs.

1. To load all disc, press the LOAD button until you hear a beep and see "LOAD" in the display. To load only one disc, press and release the LOAD button.
2. The disc number for an empty position begins blinking.
3. Insert the disc into the disc slot when the green disc load indicator comes on. Insert it only about halfway; the drive will pull it in the rest of the way. You will see "BUSY" in the display while the disc load indicator turns red and blinks as the disc is loaded.

You cannot load and play 3-inch (8-cm) discs in this unit.

4. When the disc load indicator turns green and "LOAD" appears in the display again, insert the next disc in the slot. Do not try to insert a disc until "LOAD" appears. You could damage the audio unit.
5. Repeat this until all six positions are loaded. If you are not loading all six positions, the system begins playing the last disc loaded.

You can also load a disc into an empty position while a disc is playing by pressing the appropriate preset button. The system stops playing the current disc and starts the loading sequence. It then plays the disc just loaded.

Text Data Display Function

Each time you press the TITLE button, the display shows you the text data on a disc, if the disc was recorded with text data.

You can see the album, artist, and track name in the display. If a disc is recorded in MP3 or WMA, you can see the folder and file name, and the album, artist, and track tag.

With the folder name, you will see the FOLDER indicator in the display. The TRACK indicator is shown with the file or track name.

When you press and release the TITLE button while a disc without text data is playing, you will see "NO INFORMATION" on the display.

The display shows up to about 16 characters of selected text data (the folder name, file name, etc.).

CONTINUED

Playing Discs (Models without navigation system)

If the text data has more than 16 characters, you will see the first 15 characters and the > indicator in the display. Press and hold the TITLE button until the next 16 characters are shown. You can see up to about 31 characters of the text data.

If you press and hold the TITLE button again, the display shows the first 16 characters again.

If any letter is not available, it is replaced with “.” (dot) in the display.

When the disc has no text data, you will see “NO INFORMATION” on the display.

You will also see some text data under these conditions:

- When a new folder, file, or track is selected.
- When you change the audio mode to play a disc with text data or in MP3 or WMA.

- When you insert a disc, and the system begins to play.

When playing a CD-DA with text data, the album and track name are shown in the display. With a disc in MP3 or WMA, the display shows the folder and file name.

When you turn on the audio system next time, the system keeps your selection with the TITLE button.

To Change or Select Tracks/Files

Use the SKIP buttons while a disc is playing to select passages and change tracks (files in MP3 or WMA mode).

In MP3 or WMA mode, use the TUNE knob to select folders in the disc and use either SKIP button to change files.

To select a different disc, use the appropriate preset buttons (1 through 6). If you select an empty position, the system will go into the loading sequence (see page 205).

SKIP – Each time you press and release the ►►| SKIP button, the player skips forward to the beginning of the next track (file in MP3 or WMA mode). Press and release the |◄◄ SKIP button to skip backward to the beginning of the current track. Press it again to skip to the beginning of the previous track.

Playing Discs (Models without navigation system)

To move rapidly within a track or file, press and hold the ►►| or |◄◄ SKIP button.

In MP3 or WMA mode

FOLDER SELECTION – To select a different folder, turn the TUNE knob to move to the beginning of the next folder. Turn the knob to the right until it clicks once to skip to the next folder, and to the left to move to the beginning of the current folder. Turn it again to skip to the beginning of the previous folder. Turning the TUNE knob more than two clicks skips several folders.

REPEAT (Track Repeat) – To continuously replay a track (file in MP3 or WMA mode), press and release the RPT button. You will see RPT in the display. Press and hold the RPT button to turn it off.

Pressing either SKIP button also turns off the repeat feature.

In MP3 or WMA mode

FOLDER REPEAT – This feature, when activated, replays all the files on the selected folder in the order they are compressed in MP3 or WMA. To activate folder repeat mode, press and release the RPT button repeatedly until you see F-RPT in the display. The system continuously replays the current folder. Press and hold the RPT button to turn it off. Pressing the RDM button, or selecting a different folder with the TUNE knob also turns off the repeat feature.

DISC REPEAT – This feature continuously replays the current disc. To activate disc repeat, press and release the RPT button repeatedly until you see D-RPT in the display. Press and hold the RPT button again to turn it off.

CONTINUED

Playing Discs (Models without navigation system)

Each time you press and release the RPT button, the mode changes from file repeat to folder repeat, to disc repeat then to normal playing.

RANDOM (Random within a disc)

– This feature plays the tracks within a disc (the files in MP3 or WMA mode) in random order. To activate random play, press and release the RDM button. In MP3 or WMA mode, press the RDM button repeatedly to select RDM (within a disc random play). You will see RDM in the display. Press the RDM button for 2 seconds to return to normal play.

In MP3 or WMA mode

FOLDER RANDOM – This feature, when activated, plays the files within a current folder in random order, rather than in the order they are compressed in MP3 or WMA. To activate folder random play, press and release the RDM button repeatedly. You will see F-RDM in the display. The system will then select and play files randomly. This continues until you deactivate folder random play by pressing and holding the RDM button again, or you select a different folder with the TUNE knob.

Each time you press and release the RDM button, the mode changes from folder random play, to within a disc random play, then to normal play.

SCAN – The SCAN function samples all the tracks on the disc in the order they are recorded on the disc (all files in the selected folder in MP3 or WMA mode). To activate the scan feature, press and release the SCAN button. You will see SCAN in the display. You will get a 10 second sampling of the track/file in each disc/folder. Press and hold the SCAN button to get out of scan mode and play the last track sampled.

Playing Discs (Models without navigation system)

In MP3 or WMA mode

F-SCAN – This feature, when activated, samples the first file in each folder on the disc in the order they are recorded. To activate the folder scan feature, press and release the SCAN button repeatedly. You will see F-SCAN in the display. The system will then play the first file in the main folders for about 10 seconds. If you do nothing, the system will then play the following first files for 10 seconds each. When it plays a file that you want to continue listening to, press and hold the SCAN button.

Pressing either SKIP button, or selecting a different disc (using the preset buttons) or folder (using the TUNE knob) turns off the SCAN or F-SCAN feature.

D-SCAN – This feature, when activated, samples the first track in each disc in order (the first file in the main folder on each disc in MP3 or WMA mode). To activate the disc scan feature, press and release the SCAN button repeatedly until D-SCAN shows in the display. The system will then play the first track/file in the first main folder on the first disc for about 10 seconds. If you do nothing, the system will then play the following first tracks/files for 10 seconds each. When it plays a track/file that you want to continue listening to, press and hold the SCAN button again.

When the first track in the last disc, or the first file in the last main folder in the last disc begins to play, the disc scan mode will be canceled. Pressing either skip button or selecting a different folder with the TUNE knob also turns off the scan feature.

Each time you press and release the SCAN button, the mode changes from scan, disc scan, then to normal playing.

In MP3 or WMA mode

Each time you press and release the SCAN button, the mode changes from file scan, folder scan, disc scan, then to normal playing.

CONTINUED

Playing Discs (Models without navigation system)

To Stop Playing a Disc

Press the eject button (▲) to remove the disc. If you eject the disc, but do not remove it from the slot, the system will automatically reload the disc after 10 seconds. To begin playing, press the DISC button.

You can also eject the disc when the ignition switch is off.

To play the radio when a disc is playing, press the AM or FM button. Press the DISC button again to switch back to the disc changer.

If you turn the system off while a disc is playing, either with the VOL/⏻ knob or by turning off the ignition switch, the disc will stay in the drive. When you turn the system back on, the disc will begin playing where it left off.

Removing Discs from the In-dash Disc Changer

To remove the disc currently in play, press the eject button. When a disc is removed from a slot, the system automatically begins the load sequence so you can load another disc in that position. If you do not remove the disc from the changer within 10 seconds, the disc will reload into the slot. Then the system returns to the previous mode (AM, FM, or XM).

To remove a different disc from the changer, first select it with the appropriate preset button. When that disc begins playing, press the eject button. Continue pressing the eject button to remove all the discs from the changer.

You can also eject discs when the ignition switch is off. The disc that was last selected is ejected first.

Protecting Discs

For information on how to handle and protect compact discs, see page 247.

Disc Changer Error Message (Models without navigation system)

The chart on the right explains the error messages you may see in the display while playing a disc.

If you see an error message in the display while playing a disc, press the eject button. After ejecting the disc, check it for damage or deformation. If there is no damage, insert the disc again.

For the additional information on damaged discs, see page 248.

The audio system will try to play the disc. If there is still a problem, the error message will reappear. Press the eject button, and pull out the disc.

Insert a different disc. If the new disc plays, there is a problem with the first disc. If the error message cycle repeats and you cannot clear it, take your vehicle to a dealer.

Error Message	Cause	Solution
HEAT ERROR	High temperature	Will disappear when the temperature returns to normal.
FORMAT	Track/File format not supported	Current track will be skipped. The next supported track or file plays automatically.
BAD DISC – PLEASE CHECK OWNER'S MANUAL PUSH EJECT	Mechanical Error	Press the EJECT button and pull out the disc(s). Check the disc for serious damage, signs of deformation, excessive scratches, and/or dirt (see page 248). Insert the disc again. If the code does not disappear, or the disc(s) cannot be removed, consult your dealer. Do not try to force the disc out of the player.
BAD DISC – PLEASE CHECK OWNER'S MANUAL	Servo Error	

Audio System (Models with navigation system)

Interface Dial

Most audio system functions can still be controlled by standard buttons, dials, and knobs, but some functions can only be accessed using the interface dial. The interface dial has two parts, a knob and a selector.

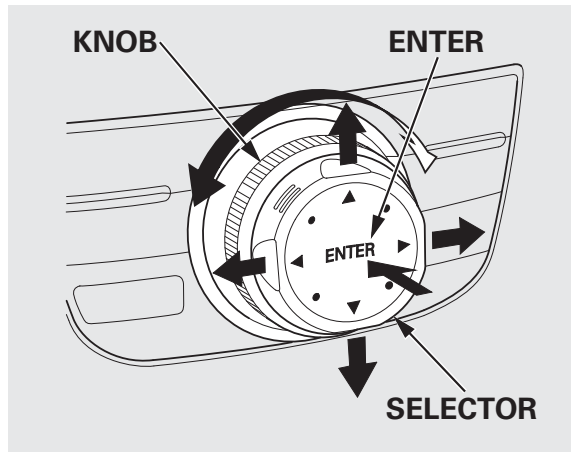

The knob turns left and right. Use it to make selections or adjustments to a list or menu on the screen.

The selector can be pushed left, right, up, down, and in. Use the selector to scroll through lists, to select menus, and to highlight menu items. When you make a selection, push the center of the selector (ENTER) to go to that selection.

Personalization Setting

When you unlock the doors with your remote and turn the audio system on, the driver's ID (Driver 1 or Driver 2) is detected, and the radio presets and sound level settings (see page 222) are turned to the respective memorized mode automatically.

Voice Control System

The audio system, including the music search feature Song By Voice™, can be operated by the voice control. See the navigation system manual for complete details.

Playing the AM/FM Radio (Models with navigation system)

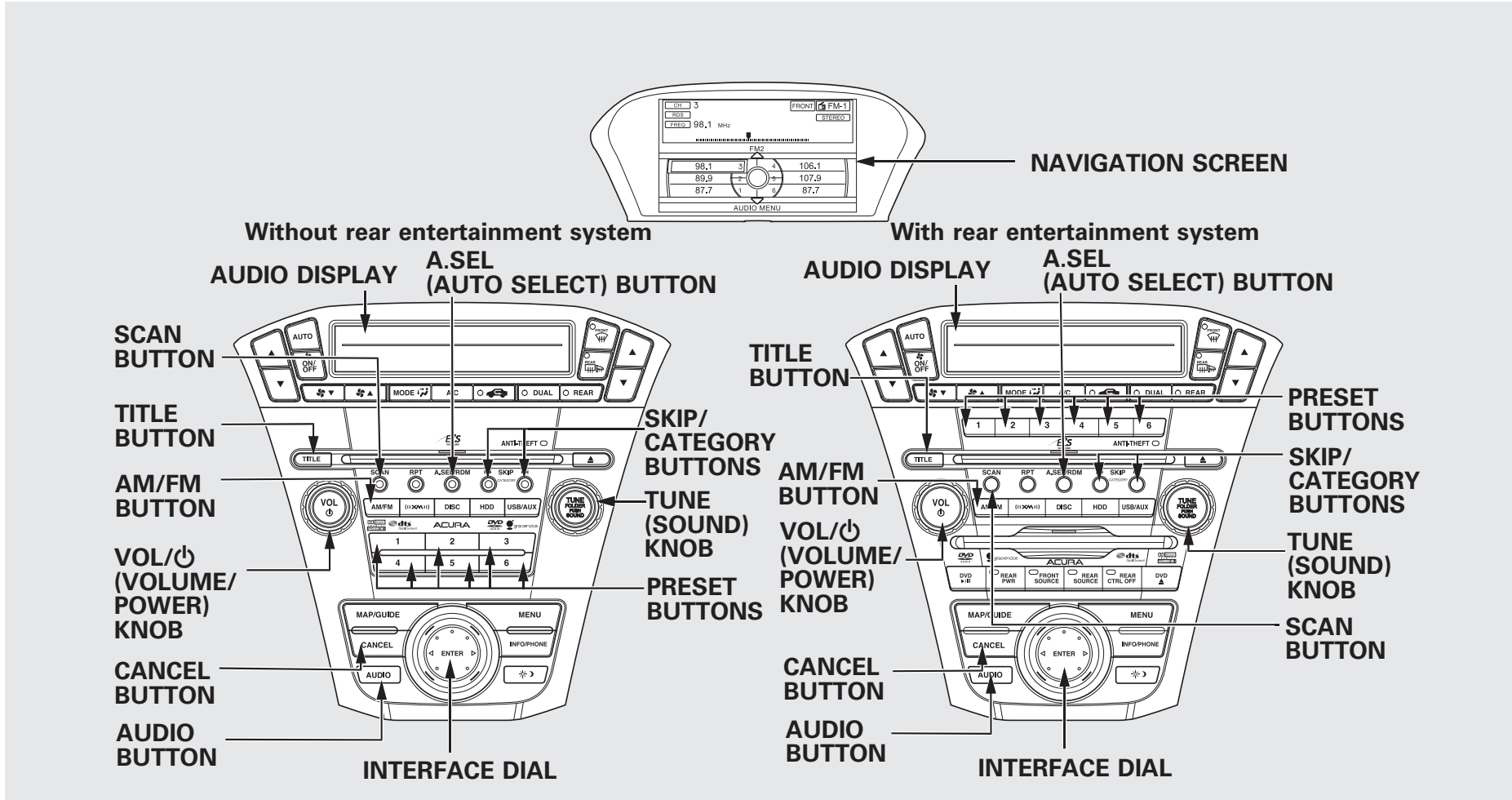

CONTINUED

Playing the AM/FM Radio (Models with navigation system)

To Play the AM/FM Radio

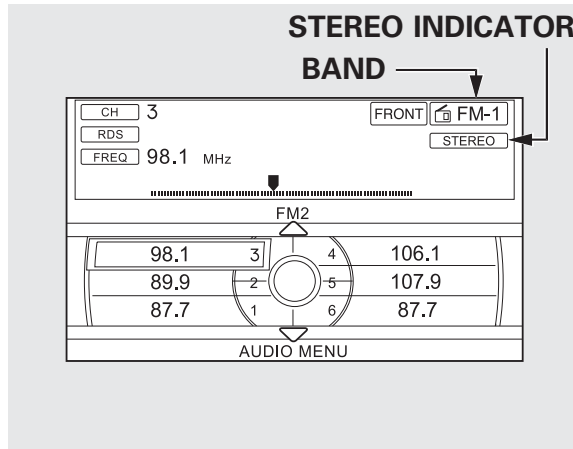

The ignition switch must be in the ACCESSORY (I) or the ON (II) position. Press the AUDIO button to view the audio control display. Turn the system on by pressing the VOL/⏻ button or the AM/FM button. Adjust the volume by turning the VOL/⏻ knob.

The band and frequency that the radio was last tuned to are shown on the display. To change bands, press the AM/FM button. You can also change bands by pushing the interface selector up. Each time you push it up, the band will change to FM1, FM2, or AM. On the FM bands, STEREO will be shown on the navigation screen and ST on the audio display, if the station is broadcasting in stereo. Stereo reproduction on AM is not available.

To Select a Station

You can use any of five methods to find radio stations on the selected band: tune, skip (seek), scan, the preset buttons, and auto select. On the FM band, you can also use the features provided by the radio data system (RDS). For more information on the RDS, see page 217.

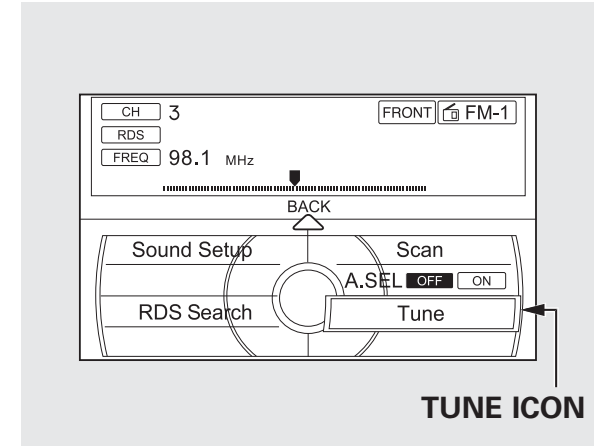

TUNE – Use the TUNE knob to tune the radio to a desired frequency. Turn the knob right to tune to a higher frequency, or left to tune to a lower frequency. To tune with the interface dial, push the selector down, and turn the knob to TUNE. Then press ENTER on the selector, and turn the knob to the desired frequency. To exit the TUNE mode, press ENTER on the interface selector, then push the interface selector up to go back.

Playing the AM/FM Radio (Models with navigation system)

SKIP (SEEK) – The skip (seek) function searches up and down from the current frequency to find a station with a strong signal. To activate it, press either side (◀◀ or ▶▶) of the SKIP button, then release it.

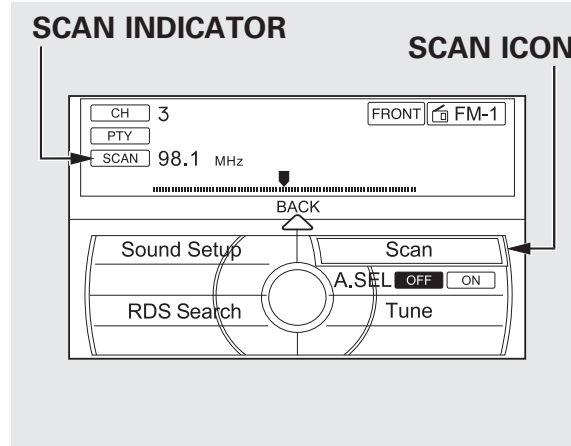

SCAN – The SCAN function samples all stations with strong signals on the selected band. To activate it, press the SCAN button, then release it.

To scan with the interface dial, push the selector down, and turn the interface dial to select Scan, then press ENTER on the interface selector.

When it finds a strong signal, it will stop and play that station for about 10 seconds. If you do nothing, the system will then scan for the next strong station and play it for 10 seconds. When it plays a station that you want to listen to, press the SCAN button again.

CONTINUED

Playing the AM/FM Radio (Models with navigation system)

Preset – Each preset button or preset icon can store one frequency on AM and two frequencies on FM.

To store a preset memory location:

1. Select the desired band, AM or FM. FM1 and FM2 let you store two sets of FM frequencies with the preset buttons (on-screen icons).
2. Use the tune, skip (seek), scan, or RDS function to tune the radio to a desired station.
3. Press the preset button, and hold it until you hear a beep. You can also store frequencies with the interface dial. Select the preset icon you want to store the frequency on, then press ENTER on the interface selector, and hold it for more than 2 seconds.
4. Repeat steps 1 through 3 to store a total of six stations on AM and twelve stations on FM.

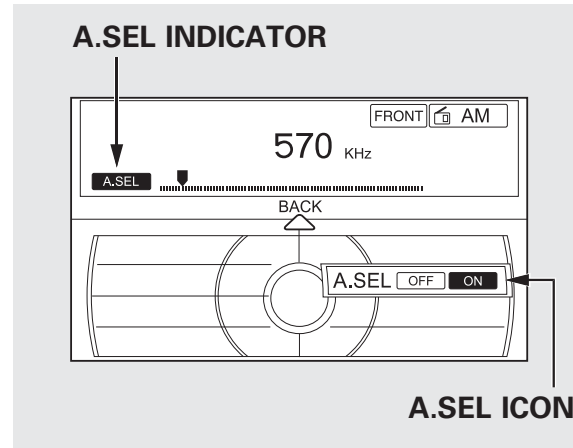

AUTO SELECT – If you are traveling and can no longer receive your preset stations, you can use the auto select feature to find stations in the local area.

Push the interface selector down to scroll down the navigation screen, highlight A.SEL, then press ENTER on the interface selector. You will see A.SEL on the audio display (if selected), and the system goes into auto select mode for several seconds.

You can also press the A.SEL button. You will see A.SEL on the audio display and the navigation screen, and the system goes into scan mode for several seconds. The system stores the frequencies of six AM and twelve FM stations in the preset buttons.

You will see “0” displayed if auto select cannot find a strong station for every preset button. If you do not like the stations auto select has stored, you can store other frequencies on the preset buttons (icons) as previously described.

To cancel auto select, select A.SEL on the audio menu again and turn the interface dial to select A.SEL OFF, or press the A.SEL button again. This restores the presets you originally set.

Playing the AM/FM Radio (Models with navigation system)

Radio Data System (RDS)

On the FM band, you can select a favorite station and display the program service name according to the information provided by the radio data system (RDS) if the station has the RDS information available.

RDS INFO Display

The RDS INFO display function shows the name of the station you are listening to. With the audio system on and the FM band selected, you can turn this function on or off.

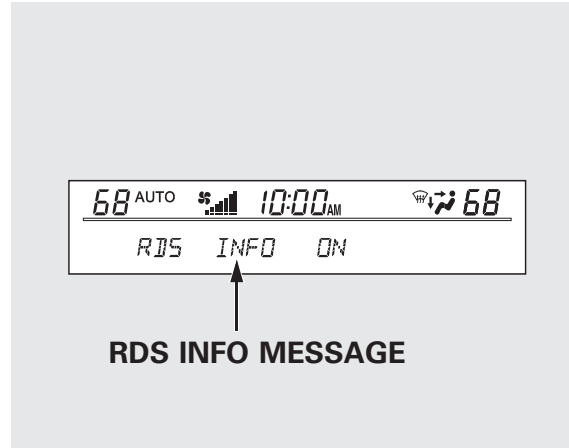

To switch the RDS INFO display function on and off, press and release the TITLE button. With the system on, you will see the “RDS INFO ON” message on the audio display. If the station you are listening to is an RDS station, the displayed frequency switches to the station name.

If the station you are listening to is not an RDS station, the navigation screen and the audio display continue to show the frequency.

When you turn off this function by pressing the TITLE button, the audio display shows “RDS INFO OFF.”

NOTE: If the station you are listening to is an RDS station, the audio screen will always display the RDS information.

CONTINUED

Playing the AM/FM Radio (Models with navigation system)

Radio Data System (RDS) Category

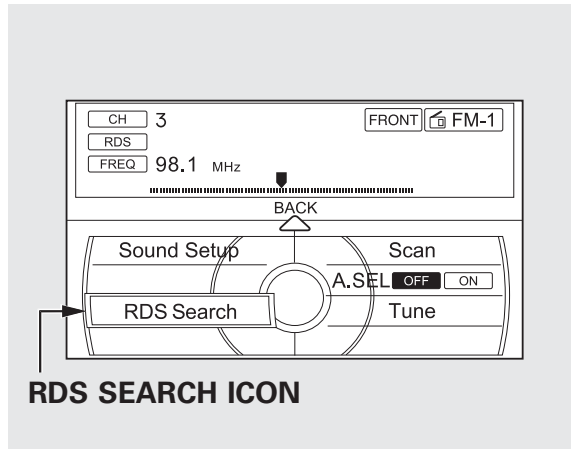

With the FM band selected, you can select the program type provided by the RDS. Press the AUDIO button to display the radio information on the navigation screen. Push down the interface selector, then turn the interface dial to select RDS Search. Press ENTER to set your selection. The principal RDS categories are shown as follows:

ALL: All RDS category stations
COUNTRY: Country music.
TOP 40: Top 40 hits
ROCK: Rock, classic rock and soft rock music
OLDIES: Nostalgia music and oldies
JAZZ: Jazz
SOFT: Adult hits and soft music
R & B: Rhythm and blues, and soft rhythm and blues
CLASSIC: Classical music
RELIGION: Programs concerned with religion
INFO: News, information, sports, talk, foreign language, personality, public, college, and weather
TRAFFIC: Traffic information

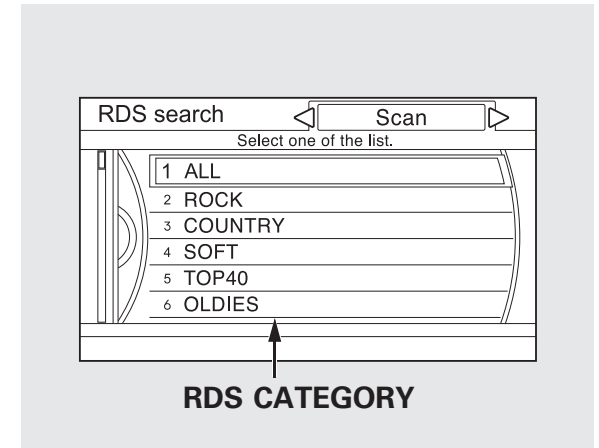

Turn the interface dial to select an RDS category. You can use the search or scan function to find radio stations on the selected RDS category by pressing the interface selector to the left or the right. Press ENTER to set your selection. If you do nothing while the RDS category is selected, the selected category is canceled.

Playing the AM/FM Radio (Models with navigation system)

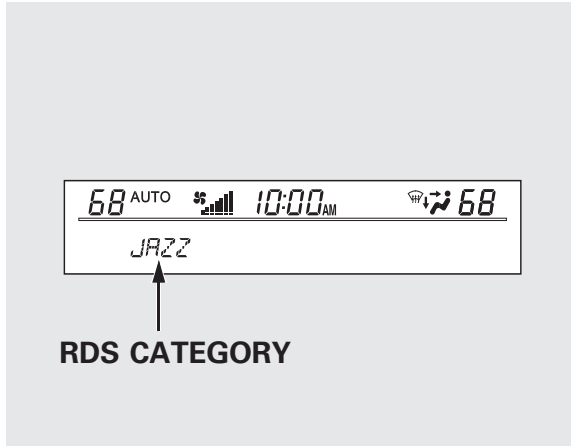

You can also select an RDS category with the CATEGORY button. Press either side (◀◀ or ▶▶) of the CATEGORY button to display an RDS category in the audio display. Select a category by pressing either side of the button.

RDS Category Search

This function searches up and down for strong signal frequencies that carries the selected RDS category information. This can help you to find a station in your favorite category. To activate it, push the AUDIO button to display the FM radio information on the navigation screen. Push the interface selector down, and turn the interface dial to select RDS search. Press ENTER on the interface selector. The screen shows you the RDS category list.

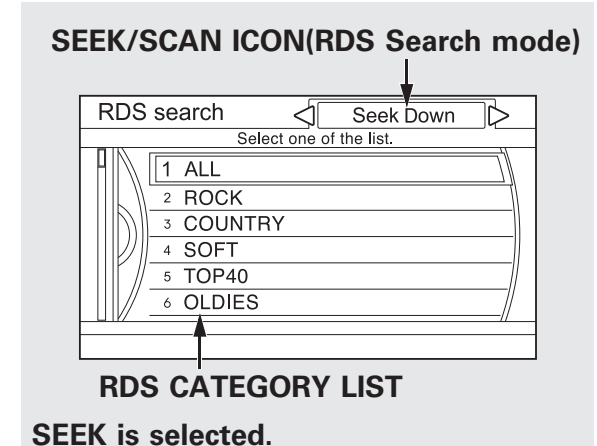

CONTINUED

Playing the AM/FM Radio (Models with navigation system)

Turn the interface dial to the desired RDS category.

While the RDS category is selected, move the interface selector to the left or right to select SEEK up, SEEK down, or SCAN in the upper right corner of the navigation screen. When you press and release ENTER to select the RDS category, RDS category search (SEEK up/down) starts.

If the system does not find a station, "NOTHING" blinks for about five seconds on the audio display, then "NOTHING" blinks for about five seconds on the navigation screen and the system will go back to the last selected station.

RDS Category SCAN

The scan function samples all stations with strong signals on the selected RDS category one by one. To activate it, push the AUDIO button to display the FM radio information on the navigation screen. Push the interface selector down, and turn the interface dial to select RDS search on the audio menu. Press ENTER on the interface selector. The screen shows you the RDS category list.

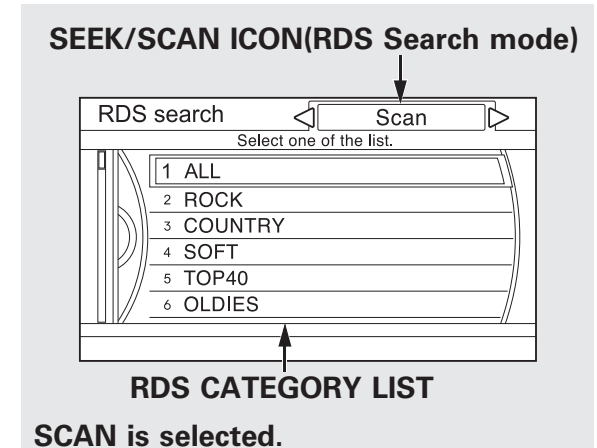

Playing the AM/FM Radio (Models with navigation system)

Turn the interface dial to the desired RDS category. While the RDS category is selected, move the interface selector to the left or the right to select SCAN. When you press and release ENTER to select the RDS category, RDS program SCAN starts. The system will scan for a station with a strong signal in the selected RDS category. You will also see the selected RDS category name blinking in the audio display while scanning it. When the system finds one, it will stop and play that station for about 10 seconds.

If you do nothing, the system will scan for the next strong station and play it for 10 seconds. When it plays a station that you want to listen to, press the CANCEL button.

If the system does not find a station, “NOTHING” blinks for about five seconds on the audio display, then “NOTHING” blinks for about five seconds on the navigation screen and the system will go back to the last selected station.

Radio Text Display

This function displays the radio text information of the selected RDS station.

If the selected RDS station has the radio text information, you will see the text indicator on the navigation screen.

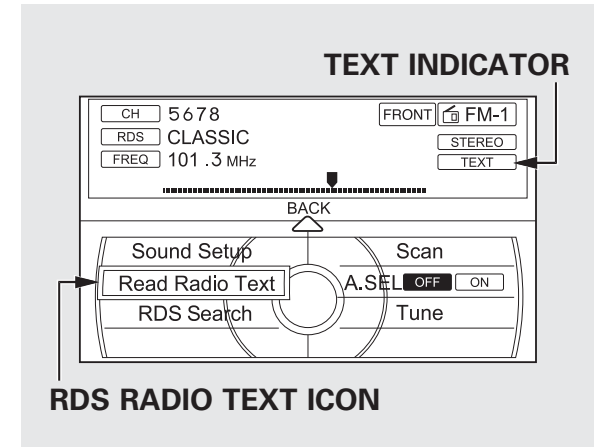

To activate radio text display, use the interface dial. Push the interface selector down, and turn the interface dial to select Read Radio Text. Press ENTER on the interface selector to enter the setting.

CONTINUED

Playing the AM/FM Radio (Models with navigation system)

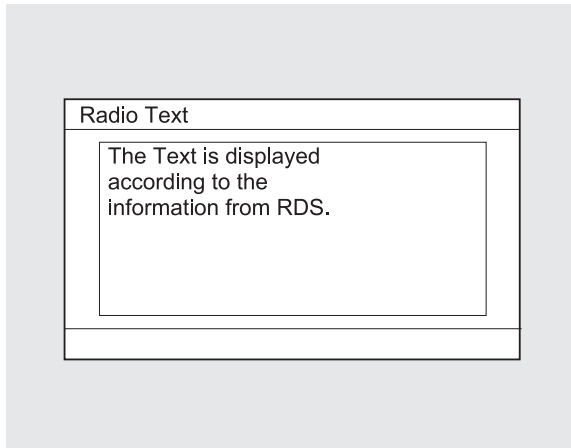

The display shows up to 64 characters on the selected RDS station.

Adjusting the Sound

BASS, TREBLE, FADER, and BALANCE are each adjustable. You can also adjust the strength of the sound coming from the center and subwoofer speakers. In addition, you can set the Dolby PL (ProLogic) II and Speed-sensitive volume compensation (SVC).

These adjustments can be made with the TUNE (SOUND) knob or the interface dial.

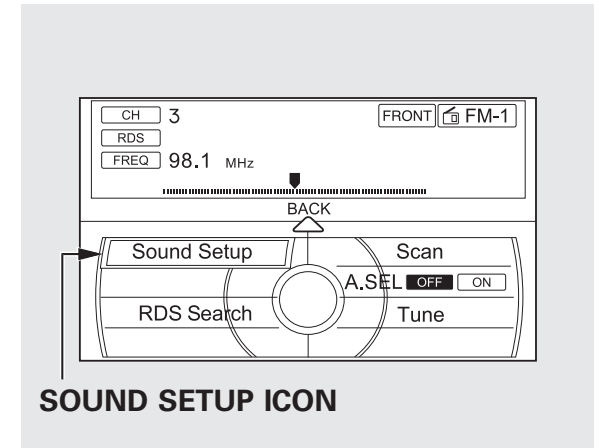

To adjust the sound, press the AUDIO button, push the interface selector down, and turn the interface dial to Sound Setup. Then press ENTER on the interface selector.

Select the mode you want to adjust by turning the interface dial.

Playing the AM/FM Radio (Models with navigation system)

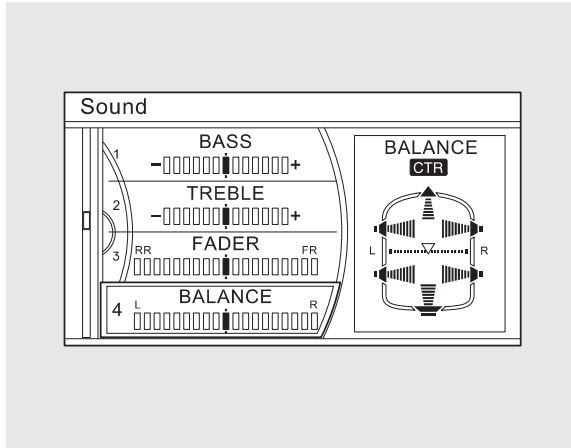

You can also adjust the sound by pushing TUNE (SOUND) knob repeatedly. Each mode is shown in the audio display as you push the button.

Turn the TUNE (SOUND) knob or interface knob to adjust the setting to your liking. You can check the level on the navigation screen or on the audio display. When the level reaches the center, you will see “C” in the audio display, and “CTR” on the navigation screen.

The system will return to the audio playing mode in the center display about 10 seconds after you stop adjusting a mode.

If you do not make an adjustment within 10 seconds, you will need to select the mode again.

BASS/TREBLE – To adjust bass and treble, select BASS or TREBLE, and press ENTER on the interface selector. The current setting is shown on the display. Turn the interface dial or TUNE (SOUND) knob to the desired level, and enter your selection by pressing ENTER on the interface selector.

FADER/BALANCE – These modes adjust the strength of the sound coming from each speaker. Fader adjusts the front-to-back strength, while balance adjusts the side-to-side strength. To adjust fader and balance, select FADER or BALANCE, then press ENTER on the interface selector. The current setting is shown on the navigation screen. Turn the interface dial or TUNE (SOUND) knob to the desired level, and enter your selection by pressing ENTER on the interface selector. To equalize the fader or balance, turn the interface dial or TUNE (SOUND) knob until the marks on the sound grid come to the center of the adjustment bar.

If the fader adjustment is set to F9 (maximum front level), the subwoofer is turned off.

CONTINUED

Playing the AM/FM Radio (Models with navigation system)

CENTER – Adjusts the strength of sound from the center speaker.

SUBWOOFER – To adjust the strength of the sound from the subwoofer speaker, select it and press ENTER on the interface selector. Turn the interface dial to the desired level, and enter your selection by pressing ENTER on the interface selector.

Speed-sensitive Volume Compensation (SVC)

The SVC mode controls the volume based on vehicle speed. The faster you go, the louder the audio volume becomes. As you slow down, the audio volume decreases.

The SVC has four modes: OFF, LOW, MID, and HIGH. To change the SVC mode, select SVC, then press ENTER on the interface selector. The current setting is shown on the screen. Turn the interface dial to the desired level, and enter your selection by pressing ENTER on the interface selector. If you feel the sound is too loud, choose low. If you feel the sound is too quiet, choose high.

Dolby PL (ProLogic) II – Dolby PL (ProLogic) II signal processing creates multi-channel surround sound from 2 channel stereo audio sources. Dolby ProLogic II can only be activated when listening to DISC (CD-DA, MP3, WMA, AAC), XM Radio, AUX (USB, iPod®, AUX, Bluetooth® Audio), and HDD Audio. When ProLogic II is available, “PL II” is shown in the audio display.

When ProLogic II is not available in the selected audio source, “PL II N/A” is shown on the center display.

ProLogic ON/OFF settings are independently controlled for DISC, XM, HDD Audio, and AUX sources.

Playing the AM/FM Radio (Models with navigation system)

To set this feature on or off, select Dolby PL II, and press ENTER on the interface selector. Rotate the interface dial to ON or OFF, and press ENTER.

Manufactured under license from Dolby Laboratories. Dolby, Pro Logic, MLP Lossless, and the double-D symbol are trademarks of Dolby Laboratories.

NOTE: In some audio playing modes (XM, AUX), when DPLII is on, the music coming from the rear speakers may sound distorted. This is due to compression of the music, and it does not indicate a problem with the setting.

Playing the XM® Radio (Models with navigation system)

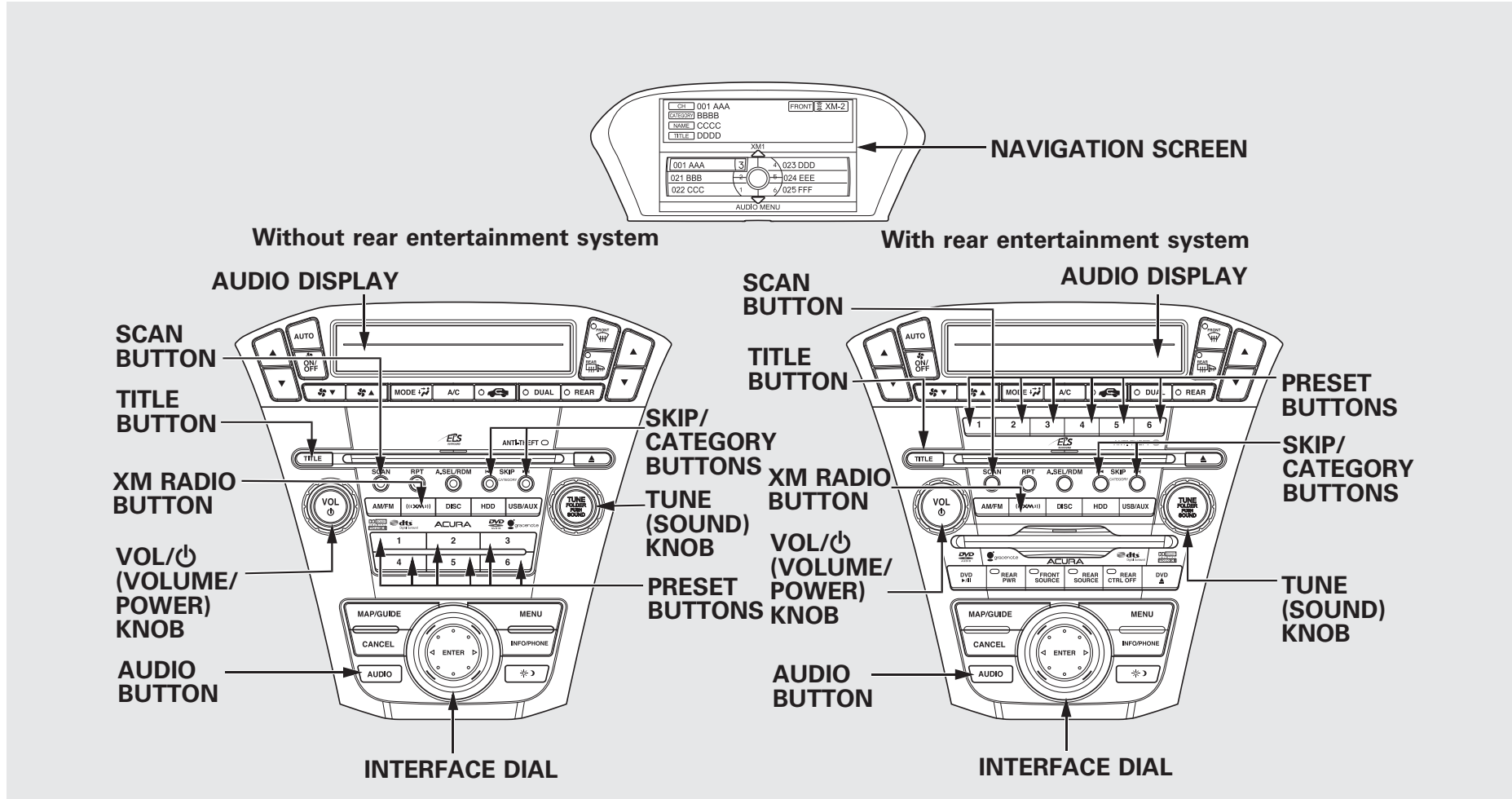

Playing the XM® Radio (Models with navigation system)

Your vehicle is capable of receiving XM® Radio anywhere in the United States, and Canada, except Hawaii, Alaska and Puerto Rico. XM is a registered trademark of Sirius XM Radio, Inc. and XM CANADA® is a registered business name of Canadian Satellite Radio Inc.

XM Radio receives signals from two satellites to produce clear, high-quality digital reception. It offers many channels in several categories. Along with a large selection of different types of music, XM Radio also allows you to view channel and category selections in the audio display.

Operating the XM Radio

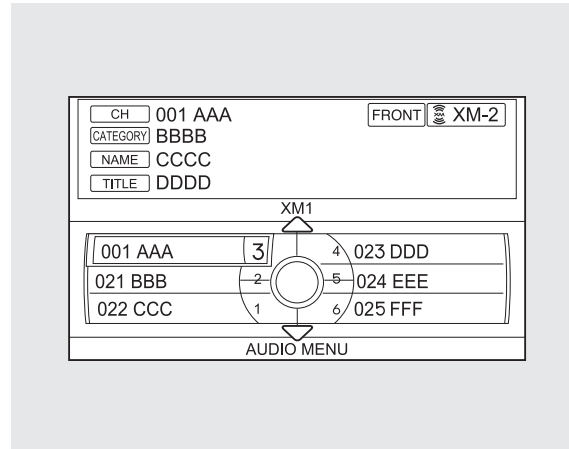

To listen to XM Radio, turn the ignition switch to the ACCESSORY (I) or ON (II) position. Push the VOL/⏻ knob to turn on the audio system, and press the button. The last channel you listened to will show in the Audio display. Adjust the volume by turning the VOL/⏻ knob.

Each time you push the interface selector up, the band will change to XM1 or XM2. Push the AUDIO button to display XM information on the navigation screen. You can operate the XM Radio system with the interface dial.

Playing the XM® Radio (Models with navigation system)

MODE – To switch between the category mode and channel mode, push the interface selector down to display AUDIO MENU, then turn the interface dial to select Mode, and press ENTER on the interface selector.

Turn the interface dial to select CH or CAT, then press ENTER on the interface selector. Move the interface selector up to go back.

You can also switch the mode by pressing the TITLE button for 3 seconds.

In the category mode, such as Jazz, Rock, Classical, etc., you can navigate through all of the channels within that category. In the channel mode, you can select all of the available channels.

Each time you press and release the TITLE button, the audio display changes in the following sequence: CATEGORY NAME, NAME (artist name), TITLE (music title), CHANNEL NAME, and CHANNEL.

On the navigation screen, you will see the selected CHANNEL (number), CATEGORY, NAME (artist name), and TITLE (music title).

You may experience periods when XM Radio does not transmit the artist's name and song title information. If this happens, there is nothing wrong with your system.

TUNE – Turn the tune knob left or right to select channels. You can also change channels with the interface selector, push down the interface selector to select AUDIO MENU, then turn the interface dial to choose Tune and press ENTER on the interface selector. Turn the interface dial to the appropriate direction. In the category mode, you can only select channels within that category.

CHANNEL LIST – Push down the interface selector to select AUDIO MENU, then turn the interface dial to select Channel List and press ENTER on the selector. Turn the interface dial to select a channel, then press ENTER to set your selection.

CATEGORY (◀◀ or ▶▶) – Press either side of the button to select another category.

Playing the XM® Radio (Models with navigation system)

SCAN – The scan function gives you a sampling of all channels while in the channel mode. In the category mode, only the channels within that category are scanned. To activate SCAN, press the SCAN button. You will see SCAN on the screen and audio display.

The system plays each channel in numerical order for about 10 seconds, then selects the next channel. When you hear a channel you want to continue listening to, press the SCAN button to cancel.

CHANNEL SCAN – This function samples all channels. Push down the interface selector to select AUDIO MENU, then turn the interface dial to select Channel Scan and press ENTER on the interface selector.

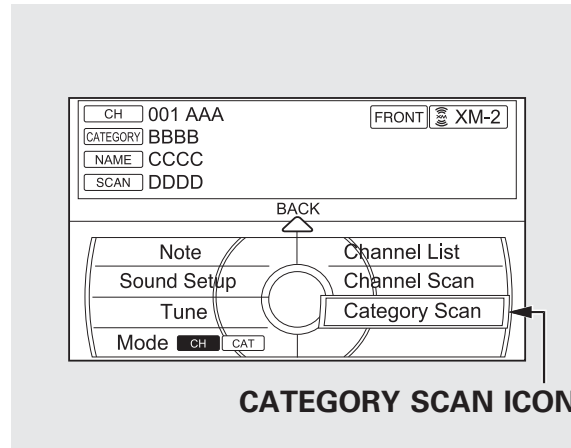

CATEGORY SCAN – This function samples the stations in the selected category. Push down the interface selector to select AUDIO MENU, then turn the interface dial to select Category Scan and press ENTER on the interface selector.

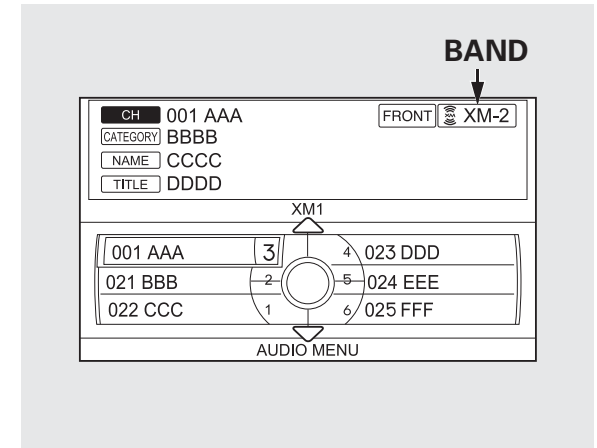

Preset – You can store up to 12 preset channels using the six preset buttons. Each button stores one channel from the XM1 band and one channel from the XM2 band.

To store a channel:

1. Press the «XM» button. Either XM1 or XM2 will be shown on the display.

CONTINUED

Playing the XM® Radio (Models with navigation system)

2. Use the tune, list, or scan function to tune to a desired channel.

In category mode, only channels within that category can be selected. In channel mode, all channels can be selected.

3. Pick the preset button you want for that channel. Press and hold the preset button until you hear a beep. You can also pick the number with the interface dial. Select your desired number and press and hold ENTER on the interface selector.
4. Repeat steps 2 and 3 to store the first six channels.
5. Press the («XM») button or scroll up again. The other XM band will be shown. Store the next six channels using steps 2 and 3.

Once a channel is stored, press and release the proper preset button to tune to it.

XM Radio Display Messages

“OFF AIR” – The channel currently selected is no longer broadcasting.

“LOADING” – XM is loading the audio or program information.

“UPDATING” – The encryption code is being updated. Wait until the encryption code is fully updated. Channels 0 and 1 should still work normally.

“NO SIGNAL” – The signal is currently too weak. Move the vehicle to an area away from tall buildings, and with an unobstructed view of the southern horizon.

“ ” – The selected channel number does not exist, or is not part of your subscription, or this channel has no artist or title information at this time.

“CHECK ANTENNA” – There is a problem with the XM antenna. Please consult your dealer.

Playing the XM® Radio (Models with navigation system)

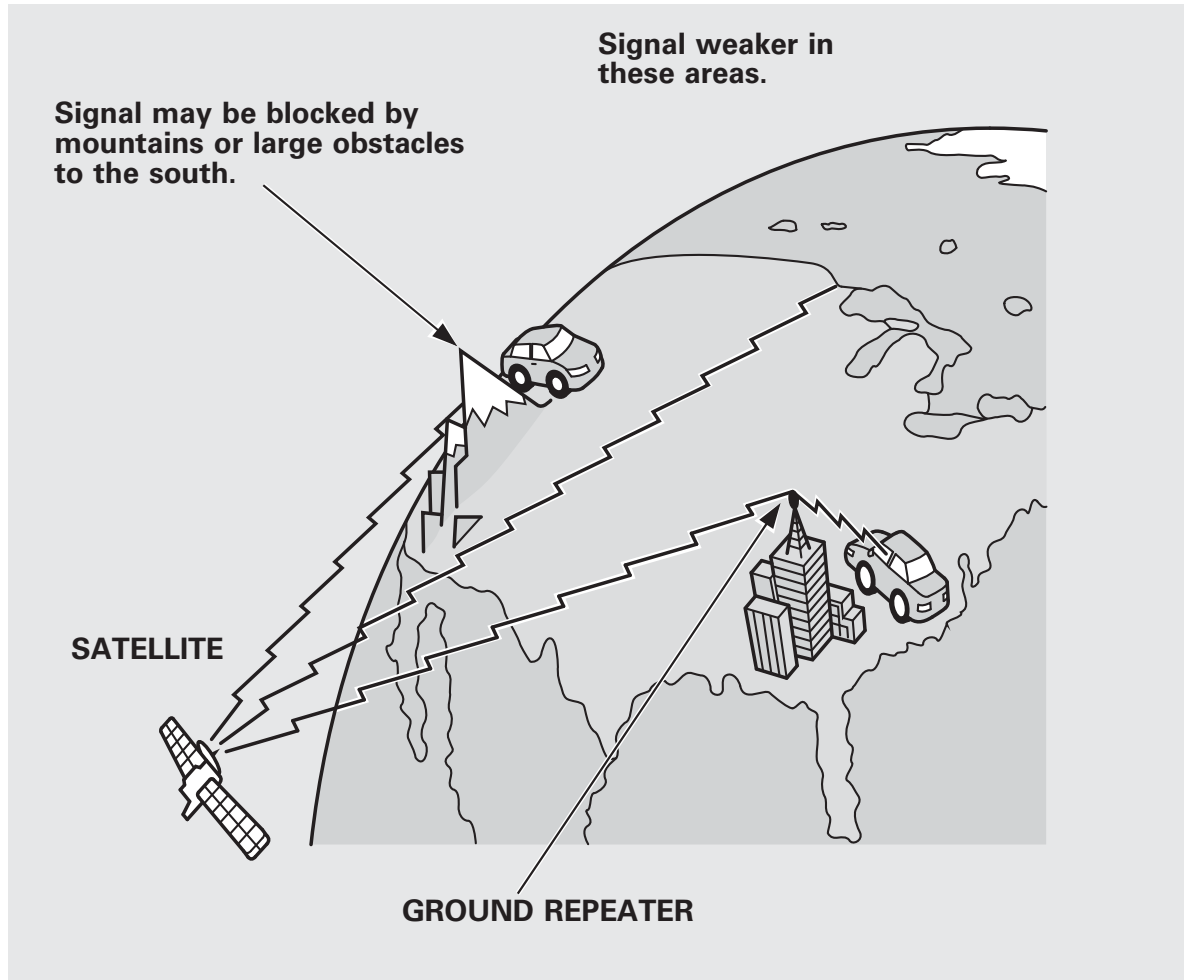

The XM satellites are in orbit over the equator; therefore, objects south of the vehicle may cause satellite reception interruptions. To help compensate for this, ground-based repeaters are placed in major metropolitan areas. Satellite signals are more likely to be blocked by tall buildings and mountains the farther north you travel from the equator.

Features

CONTINUED

Playing the XM® Radio (Models with navigation system)

Depending on where you drive, you may experience reception problems. Interference can be caused by any of these conditions:

- Driving on the north side of an east/west mountain road.
- Driving on the north side of a large commercial truck on an east/west road.
- Driving in tunnels.
- Driving on a road beside a vertical wall, steep cliff, or hill to the south of you.
- Driving on the lower level of a multi-tiered road.
- Driving on a single lane road alongside dense trees taller than 50 ft. (15 m) to the south of you.

There may be other geographic situations that could affect XM Radio reception.

*As required by the FCC:
Changes or modifications not expressly approved by the party responsible for compliance could void the user's authority to operate the equipment.*

This Category II radiocommunication device complies with Industry Canada Standard RSS-310.

Operation is subject to the following two conditions: (1) this device may not cause interference, and (2) this device must accept any interference, including interference that may cause undesired operation of the device.

Note Function

If equipped

This function stores the sound content played on the selected XM satellite radio station with the channel, category, name, and title information.

To activate this function, press and hold the (« XM ») button for about 2 seconds while a song or passage which you want to store is playing. You can record for up to 10 seconds. To stop recording, press the AM/FM button or (« XM ») button.

Once you store the recorded sound file, you can replay it and confirm the information. The system can store up to 30 sound files. If you continue to store more files, the oldest one will be deleted each time you add a new file.

Playing the XM® Radio (Models with navigation system)

NOTE ICON

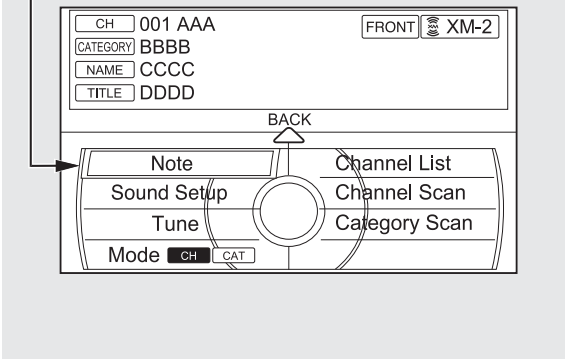

To replay and see the stored file, press the AUDIO button to select the audio display on the navigation screen.

Push down the interface selector to display the audio menu. Turn the interface dial to select Note, then press ENTER.

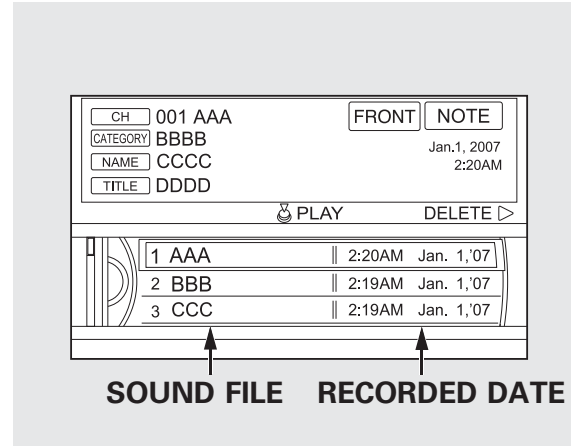

Turn the selector dial to select a sound file, then press ENTER. The display shows the category, name and title information of the selected file.

To delete a file, push the interface selector to the right to select “DELETE.” Select “DELETE ALL” or “DELETE SELECTED ITEM,” then press ENTER on the interface selector.

CONTINUED

Playing the XM® Radio (Models with navigation system)

Receiving XM Radio Service

If your XM Radio service has expired or you purchased your vehicle from a previous owner, you can listen to a sampling of the broadcasts available on XM Radio. With the ignition switch in the ACCESSORY (I) or the ON (II) position, press the (« XM ») button. A variety of music types and styles will play.

If you decide to purchase XM Radio service, contact XM Radio at www.siriusxm.com, or at 1-800-852-9696. In Canada, contact XM CANADA® www.xmradio.ca, or at call 1-877-209-0079. You will need to give them your radio I.D. number and your credit card number. To get your radio I.D. number, turn the TUNE knob until “0” appears in the display. Your I.D. will appear in the displays.

After you have registered with XM Radio, keep your audio system in the XM Radio mode while you wait for activation. This should take about 30 minutes.

While waiting for activation, make sure your vehicle remains in an open area with good reception. Once your audio system is activated, CAT (category) or CH (channel) will appear in the audio display, and you'll be able to listen to XM Radio broadcasts. XM Radio will continue to send an activation signal to your vehicle for at least 12 hours from the activation request. If the service has not been activated after 36 hours, contact XM® Radio. In Canada, contact XM CANADA®.

Playing a Disc (Models with navigation system)

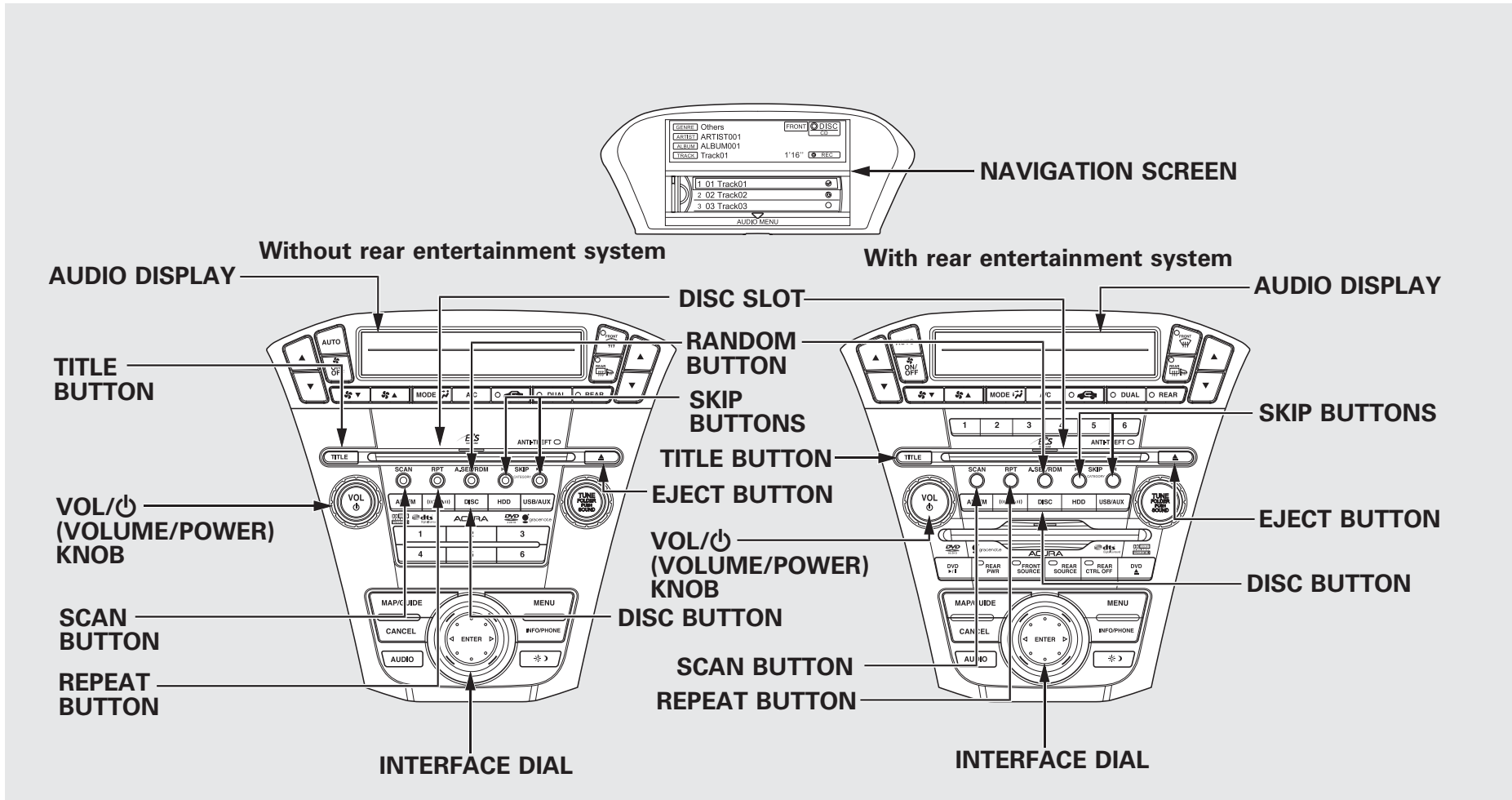

CONTINUED

Playing a Disc (Models with navigation system)

Your vehicle's audio system has an internal disc player. To operate the disc player, the ignition switch must be in the ACCESSORY (I) or the ON (II) position.

The disc player can play these disc formats:

- CD (CD-DA)
- CD-R/RW (MP3, WMA, AAC)
- DVD-A
- DVD-R/RW

The disc packages or jackets should have one of these marks.



The disc player can also play MP3, WMA, or AAC format that saved on CD-R/RW or DVD-R/RW (see page 241).

NOTE:

If a file on an MP3, WMA, or ACC disk is protected by digital rights management (DRM), the audio system skips to the next file.

DVD-A discs not meeting DVD verification standards may not be playable.

Some CD-DA and CD-ROM mixed discs are not playable.

On models without Rear Entertainment System
Video CDs and DVD-V format discs will not work in this unit.

Playing a Disc (Models with navigation system)

It is possible to select up to 999 files for inclusion in CD-Rs and CD-RWs, and up to 3,500 files for inclusion in DVD-Rs and DVD-RWs.

NOTICE

Do not use discs with adhesive labels. The label can curl up and cause the disc to jam in the unit.

Manufactured under license under U.S. Patent #'s: 5,451,942; 5,956,674; 5,974,380; 5,978,762; 6,487,535 & other U.S. and worldwide patents issued & pending. DTS and DTS Digital Surround are registered trademarks and the DTS logos and Symbol are trademarks of DTS, Inc. © 1996 – 2008 DTS, Inc. All Rights Reserved.

To Load a Disc

Insert a disc about halfway into the disc slot. The drive will pull the disc in the rest of the way to play it. You operate the disc player with the same controls used for the radio. The number of the current track is shown in the display. When playing a disc in MP3, WMA or AAC, the numbers of the current folder and file are shown. The system will continuously play a disc until you change modes.

For information on how to handle and protect compact discs, see page 247.

To Play a Disc

Select the disc player by pressing the DISC button. The system will begin playing the last selected track in the disc. You will see the current track position highlighted.

Title information will be displayed by a list when the information is found in the Gracenote® Album Info (Gracenote® Media Database) on the built-in hard disk drive. When you play a CD recorded with text data, you will see the genre, artist name, album and track name on the screen. When you play MP3/WMA/AAC discs, you will see the genre, artist name, album name and track name on the screen. If the disc was not recorded with this information, it will not be displayed.

CONTINUED

Playing a Disc (Models with navigation system)

Each time you press the TITLE button, the audio display changes from artist name to album name, to track name and then to normal display that shows the track number and the elapsed time. When playing a disc in MP3/WMA/AAC, the display mode changes from folder name, to file name, to artist tag, to album tag, to track tag, and then to normal display.

To Change Tracks

Each time you press and release the ►► side of the skip button, the player skips forward to the beginning of the next track. Press and release the ◀◀ side of the skip button to skip backward to the beginning of the current track. Press the ◀◀ side again to skip to the previous track. To move rapidly within a track, press and hold either side of the skip button.

When you insert a CD for the first time, the system automatically starts recording to the hard disc. For information on recording from music CDs, see page 253.

To Choose a Track

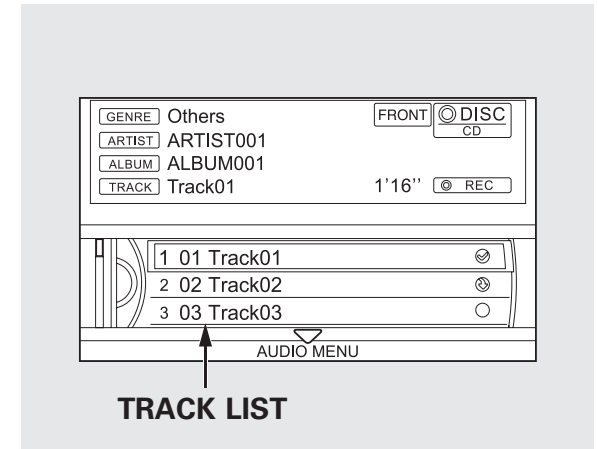

You can also choose a track directly from a track list. If there are no track names, you will see “No Title” displayed. Turn the interface dial to select the desired track, then press ENTER on the interface selector.

Playing a Disc (Models with navigation system)

Track Repeat

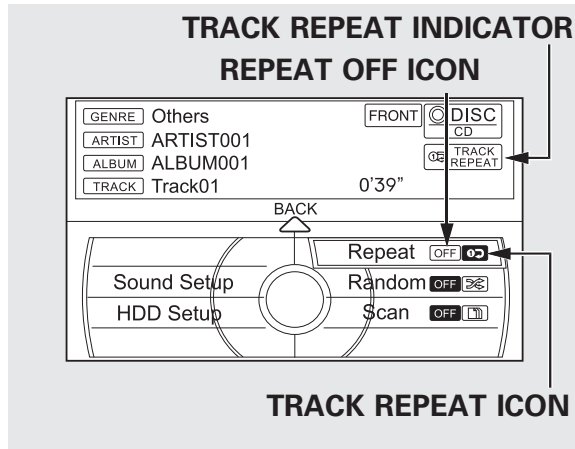

To replay the current track continuously, push the interface selector down while playing a disc. Turn the interface dial to select Repeat on the AUDIO MENU, and press ENTER on the interface selector. Turn the interface dial to select the Repeat icon, and press ENTER on the interface selector.

To turn this feature off, turn the interface dial to select the OFF icon, and press ENTER on the interface selector.

Random Play

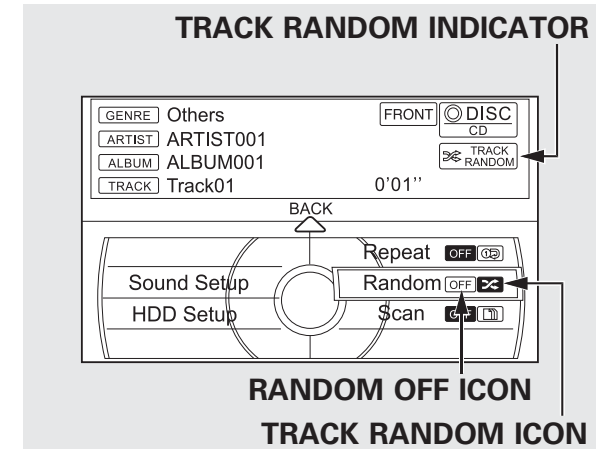

This feature plays the tracks within a disc in random order. When playing MP3, WMA or AAC format discs, all the tracks within the disc are played in random order, regardless of the configuration of the folder.

Push the interface selector down while playing a disc. Turn the interface dial to select Random on the AUDIO MENU, and press ENTER on the interface selector.

CONTINUED

Playing a Disc (Models with navigation system)

Turn the interface dial to select the track random icon, and press ENTER on the interface selector.

To turn this feature off, turn the interface dial to select the OFF icon, and press ENTER on the interface selector.

Track Scan

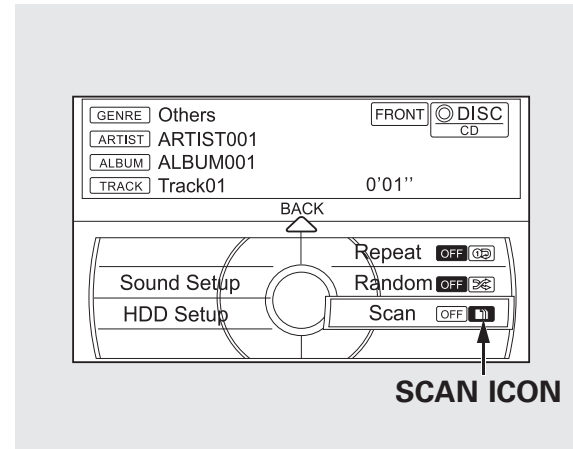

The scan function samples all tracks on the disc in the order they are recorded on the disc.

To activate scan, press the SCAN button, or push the interface selector down while playing a disc. Turn the interface dial to select Scan on the AUDIO MENU, and press ENTER on the interface selector.

Turn the interface dial to select the Scan icon, and press ENTER on the interface selector. You will hear a 10-second sampling of each track on the disc. When you return to disc mode, the disc will begin playing from where it left off.

To turn this feature off, press the SCAN button again, or turn the interface dial to select the OFF icon, and press ENTER on the interface selector. The system begins to play the last track sampled.

Playing a Disc (Models with navigation system)

To Stop Playing a Disc

To take the system out of disc mode, press the AM/FM button, the (« \times »») button, or the HDD button. To return to disc mode, press the DISC button.

If you turn the system off while a disc is playing, either with the VOL/⏻ knob or the ignition switch, the disc will stay in the drive. When you turn the system back on, the disc will begin playing where it left off.

Playing an MP3/WMA/AAC Disc

This audio system plays CD-ROM, CD-R/RW, DVD-ROM, and DVD-R/RW compressed in MP3, WMA, or AAC formats. You can select up to 255 folders or tracks.

Disc	Maximum folders*	Maximum Files	Maximum layers*
CD-ROM CD-R CD-RW	255	999	8
DVD-ROM DVD-R DVD-RW	255	3500	8

* Including Root folder

NOTE:

Combining a low sampling frequency with a low bitrate may result in extremely degraded sound quality.

To play an MP3/WMA/AAC disc, use the disc controls previously described, along with the following information.

Depending on the software the files were made with, it may not be possible to play some files, or display some text data.

CONTINUED

Playing a Disc (Models with navigation system)

Changing the Folders

While playing an MP3/WMA/AAC disc, you can select a folder within the disc by pressing either side of the category button. Each time you press either side of the button, the folder title and its first file's information appear on the audio display and on the navigation screen in hierarchical order of the folders which contain files within the disc.

Changing and Selecting the Folders/ Files

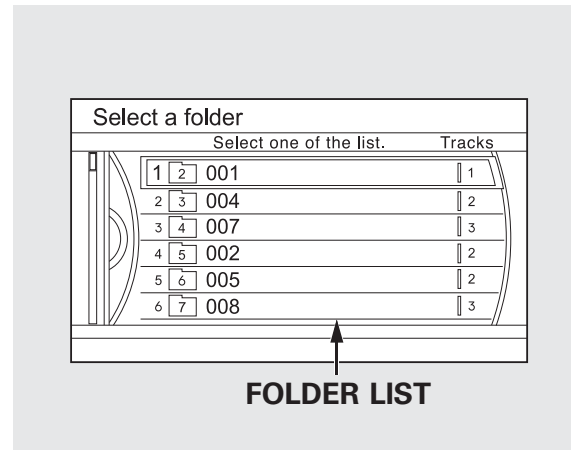

Using the interface selector, you can see the list of all the folders within a disc. While playing an MP3/WMA/AAC disc, push the interface selector up. The folder list in the currently playing disc will appear on the screen.

If the root folder has some additional folders in the lower layer, they will be listed on the screen.

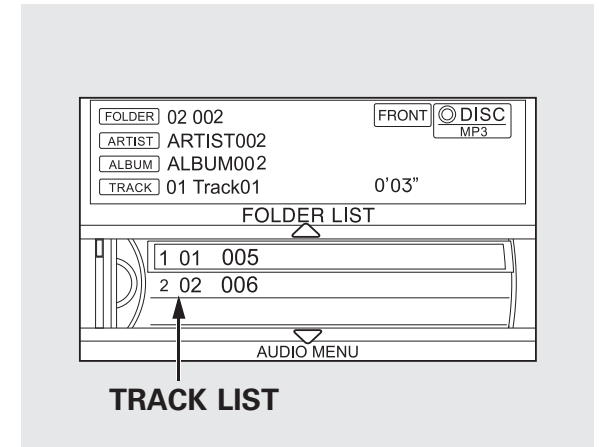

Select a desired folder by turning the interface dial, then press ENTER. The display returns to normal play, and the first track in the selected folder begins to play.

To change a file, turn the interface dial to select a desired file, then press ENTER.

Playing a Disc (Models with navigation system)

Folder Repeat

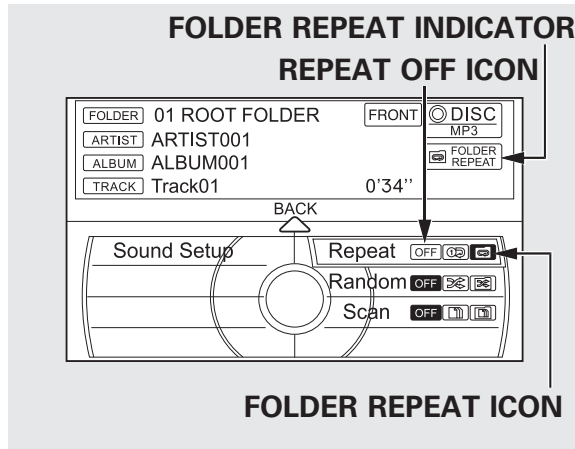

This feature, when activated, replays all files in the selected folder in the order they are compressed. To activate folder repeat play, push the interface selector down while playing a disc. Turn the interface dial to select Repeat on the AUDIO MENU, and press ENTER on the interface selector. Turn the interface dial to select the folder repeat icon, and press ENTER on the interface selector.

To turn this feature off, turn the interface dial to select the OFF icon, and press ENTER on the interface selector.

Folder Random

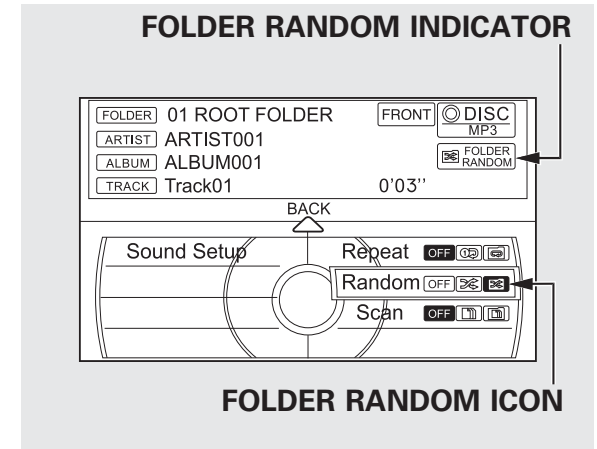

This feature, when activated, plays all files in the current folder in random order. To activate folder random play, push the interface selector down while playing a disc. Turn the interface dial to select Random on the AUDIO MENU, and press ENTER on the interface selector. Turn the interface dial to select the folder random icon, and press ENTER on the interface selector.

CONTINUED

Playing a Disc (Models with navigation system)

To turn this feature off, turn the interface dial to select the OFF icon, and press ENTER on the interface selector.

File Scan

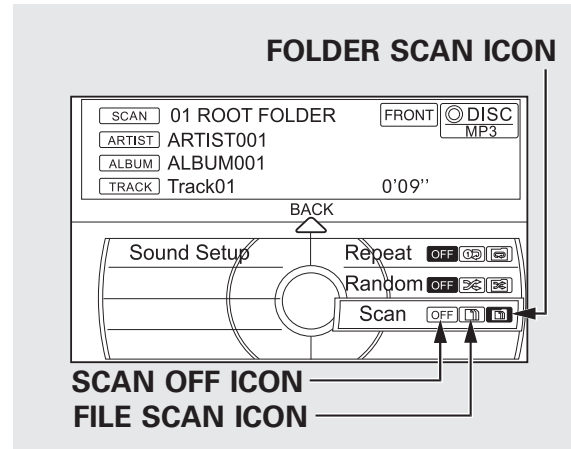

This feature samples all files in the selected folder in the order they are stored. To activate this feature, press the SCAN button. You can also select the SCAN icon with the interface dial. Push the selector down, turn the dial to select Scan on the AUDIO MENU, then press ENTER. Turn the dial to select the scan icon, then press ENTER.

The system begins to play a file for about 10 seconds, and continues to sample the remaining files.

To turn this feature off, press the SCAN button again, or select the OFF icon by turning the dial, then press ENTER.

Folder Scan

This feature, when activated, samples the first file of each folder for 10 seconds. To scan a folder, press the SCAN button. Or, push the interface selector down while playing a disc. Turn the interface dial to select Scan on the AUDIO MENU, and press ENTER on the interface selector. Turn the interface dial to select the folder scan icon, and press ENTER on the interface selector.

The system plays the first file in the first folder for about 10 seconds. If you do nothing, the system will then play the first files in the next folders for 10 seconds. After playing the first file of the last folder, the system plays normally.

To turn this feature off, turn the interface dial to select the OFF icon, and press ENTER on the interface selector. The last track sampled begins to play.

NOTE:

When playing MP3, WMA or AAC format disc, each time you press the SCAN button, the system changes in the following sequence: Scan → Scan first track in folder → OFF → Scan.

Removing Discs from the Disc Player

To remove the disc, press the eject (▲) button.

If you do not remove the disc from the slot, the system will reload the disc after 10 seconds. The disc starts playing automatically.

Playing a DVD-A Disc

Use the disc controls previously described.

Disc Player Error Messages (Models with navigation system)

The chart on the right explains the error messages you may see in the audio display while playing a disc.

If you see an error message in the audio display while playing a disc, press the eject button. After ejecting the disc, check it for damage or deformation. If there is no damage, insert the disc again. For additional information on damaged discs, see page 248.

The audio system will try to play the disc. If there is still a problem, the error message will reappear. Press the eject button, and pull out the disc. Insert a different disc. If the new disc plays, there is a problem with the first disc. If the error message cycle repeats and you cannot clear it, take your vehicle to a dealer.

Error Message	Cause	Solution
BAD DISC PLEASE CHECK OWNER'S MANUAL	Servo Error	Press the eject button and pull out the disc. Check the disc for serious damage, signs of deformation, excessive scratches, and/or dirt (see page 248). Insert the disc again. If the code does not disappear, or the disc cannot be removed, consult your dealer. Do not try to force the disc out of the player.
BAD DISC PLEASE CHECK OWNER'S MANUAL PUSH EJECT	Mechanical Error	
MECH ERROR		
CHECK DISC	FOCUS Error Disc violates copyright Disc not supported	
CHECK DISC LOAD	Load Error	
HEAT ERROR	High Temperature	Will disappear when the temperature returns to normal.

General Information

- When using CD-R, CD-RW, DVD-R or DVD-RW discs, use only high quality discs labeled for audio use.
- When recording a CD-R, CD-RW, DVD-R or DVD-RW the recording must be closed for it to be used by the disc player.
- When using DVD-R/RW discs, they should meet DVD verification standards.
- Play only standard, round, 5-inch (12 cm) discs. Smaller or odd-shaped discs may jam in the drive or cause other problems.
- Handle your discs properly to prevent damage and skipping.

NOTICE

Do not use discs with adhesive labels. The label can curl up and cause the disc to jam in the unit.

Protecting Discs

When a disc is not being played, store it in its case to protect it from dust and other contamination. To prevent warpage, keep discs out of direct sunlight and extreme heat.

To clean a disc, use a clean soft cloth. Wipe across the disc from the center to the outside edge.

A new disc may be rough on the inner and outer edges. The small plastic pieces causing this roughness can flake off and fall on the recording surface of the disc, causing skipping or other problems. Remove these pieces by rubbing the inner and outer edges with the side of a pencil or pen.

Never try to insert foreign objects in the disc player.

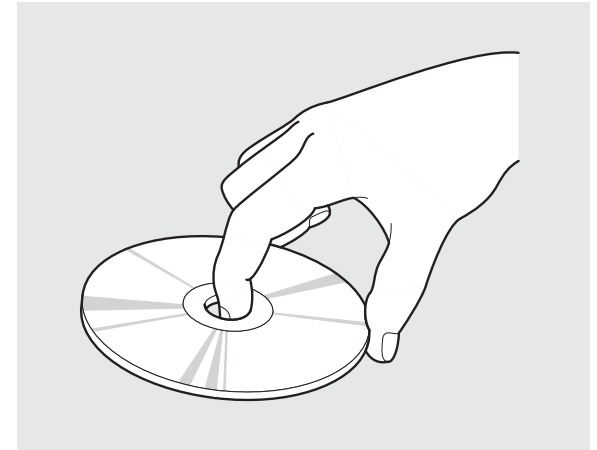

Handle a disc by its edges; never touch either surface. Do not place stabilizer rings or labels on the disc. These, along with contamination from finger prints, liquids, and felt-tip pens, can cause the disc to not play properly, or possibly jam in the drive.

CONTINUED

Protecting Your Discs

Additional Information on Recommended Discs

The in-dash disc player has a sophisticated and delicate mechanism. If you insert a damaged disc as indicated in this section, it may become stuck inside and damage the audio unit.

Examples of these discs are shown to the right:

1. Bubbled, wrinkled, labeled, and excessively thick discs

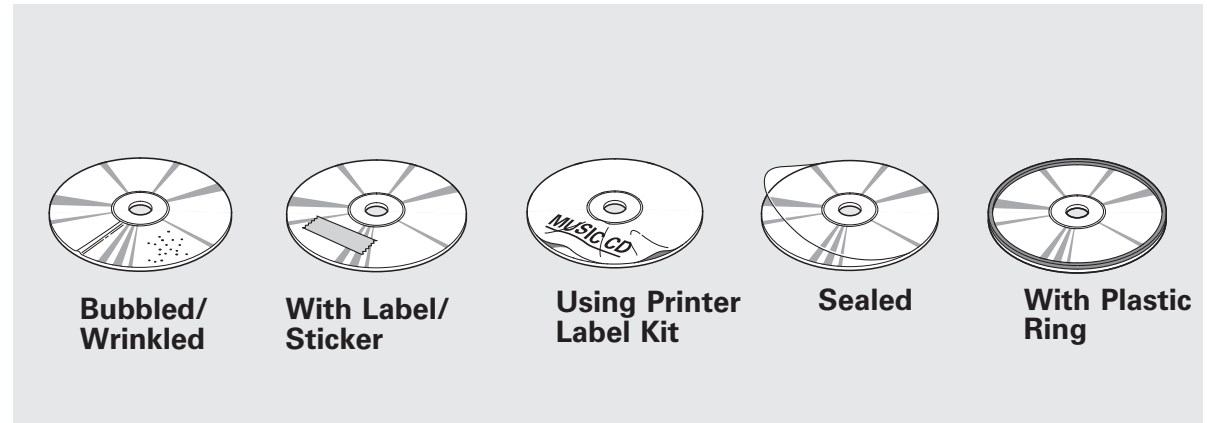

2. Damaged discs

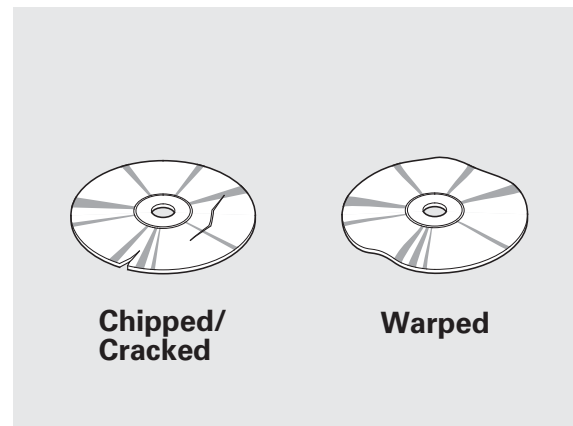

3. Poor quality discs

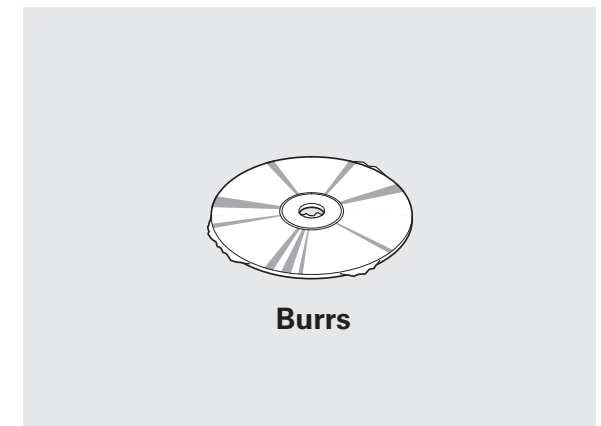

4. Small, irregular shaped discs

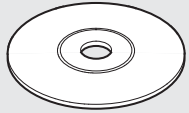

3-inch (8-cm) CD
(Only on models with CD changer.)

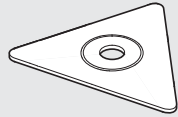

Triangle Shape

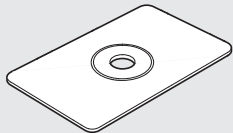

Can Shape

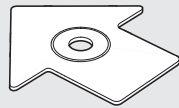

Arrow Shape

5. Discs with scratches, dirty discs

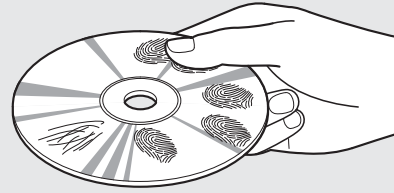

Fingerprints, scratches, etc.

- CD-R, CD-RW, DVD-R or DVD-RW may not play due to the recording conditions.
- Scratches and fingerprints on the discs may cause the sound to skip.

- Recommended discs are printed with the following logo.



- Audio unit may not play the following formats.



- This audio unit cannot play a Dual-disc®.

Playing Hard Disc Drive (HDD) Audio (Models with navigation system)

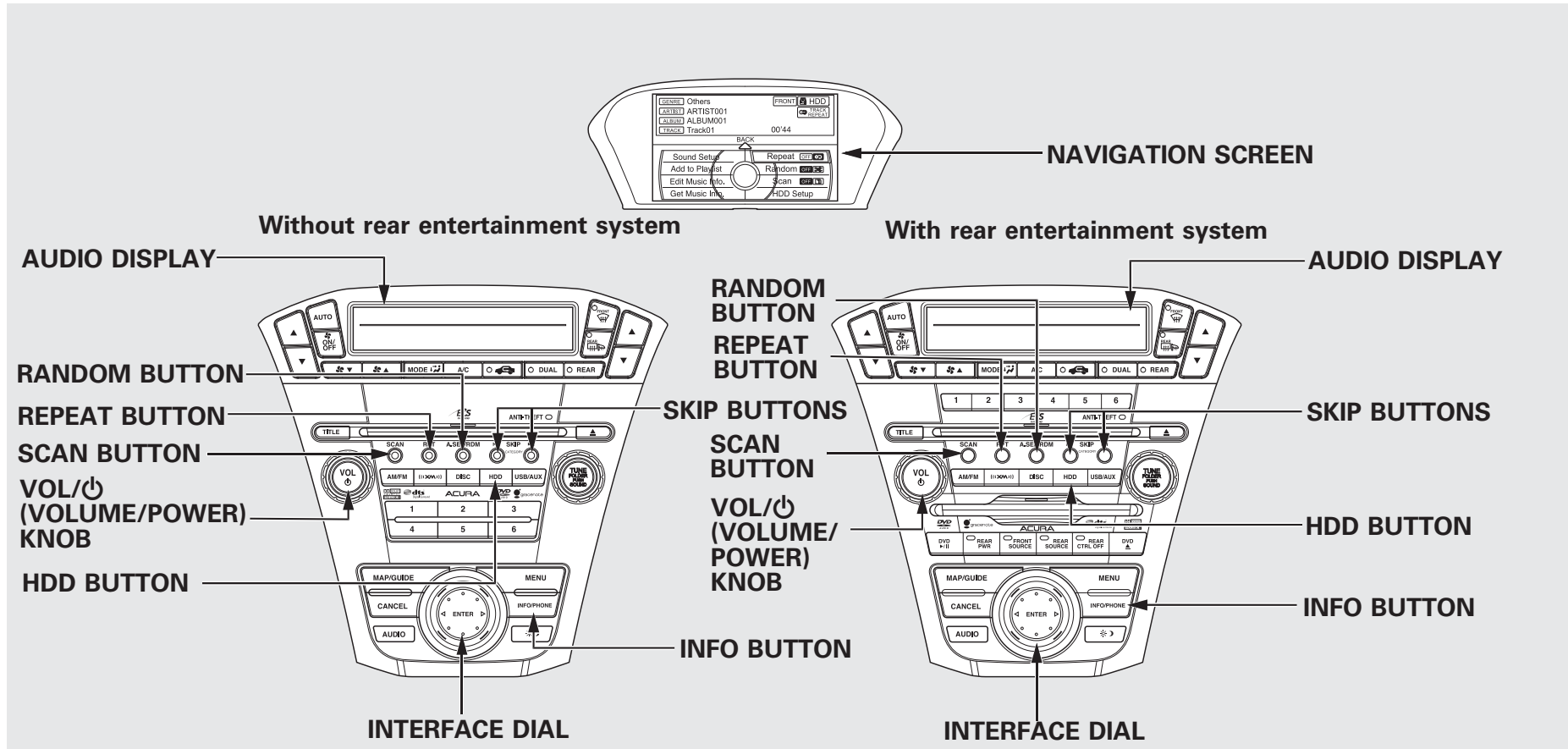

Playing Hard Disc Drive (HDD) Audio (Models with navigation system)

The Hard Disc Drive (HDD) Audio function can record tracks from music CDs to the navigation system's hard disc. This function also allows for various playing methods, such as playing recorded tracks on an artist-by-artist or genre-by-genre basis. For example, you can play the tracks that you want to listen to in any order that you like for each playlist.

NOTE:

- Only recordings from a standard CD-DA (44.1 kHz, 16 bit stereo PCM digital sound data) to HDD are supported.
- Digital music files, such as MP3, WMA, AAC etc., in CD-R, DVD-R and USB flash memory devices cannot be copied to HDD. Likewise, digital music files recorded to HDD cannot be copied to CD-R, DVD-R and USB devices.

- Music data recorded on HDD can only be used for personal enjoyment.
- Data is recorded using ultra-efficient compression technology, therefore, sound quality may vary slightly from the original.
- Title information will be displayed when the information is found in the Gracenote® Album Info (Gracenote® Media Database) on the built-in hard disk drive. See page 275.

- Recording function from following media is not supported.
 - CD-DA which prohibits the copy by SCMS
 - CD-DA with copy control
 - SACD (Super Audio CD)
 - DTS-CD
 - DVD-A
 - CD-R/RW
 - DVD-R/RW
 - Copy controlled CDs (Playback cannot be guaranteed)
 - DTS-CDs (Only enabled for playback)

If the HDD is ever replaced, all data will be lost and stored music will not be recovered.

CONTINUED

Playing Hard Disc Drive (HDD) Audio (Models with navigation system)

Playlists

Playlists are track lists in a certain playback group.

Original Playlist

This playlist is automatically generated when the music CD is recorded. The maximum number of original playlists that can be stored to the HDD is 999, with 99 songs on each playlist. Each album name on the music CD is counted as a playlist.

User Playlist

The HDD has six playlist folders for user customizing. Each playlist can be edited by the user, and will store up to 999 songs. For more information of how to edit the user playlist, see page 263.

Track Search Methods

Songs that have been recorded on the HDD are categorized in groups for easy searching.

There are six categories:

Ripped date: Album titles are arranged by date of recording.

Album: Album names are arranged in alphabetical order.

Artist: Artist names are arranged in alphabetical order.

Genre: Songs are arranged by genre.

Playlist: Any of six playlists that are arranged by the user

Track: Track titles are arranged in alphabetical order.

For more information on how to search for music on the HDD, see page 258.

Playing Hard Disc Drive (HDD) Audio (Models with navigation system)

Recording a Music CD to HDD Audio

If you play a music CD that has not yet been recorded on the HDD, the system will automatically begin recording to the HDD once the disc is loaded. To turn this feature off, see page 254.

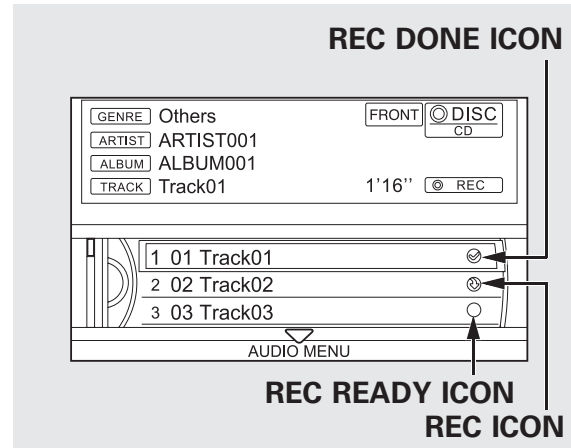

The icons show the recording conditions for each track:
Rec icon: Now recording
Rec ready icon: Next to be recorded
Rec done icon: Recording finished

NOTE:

- Please note that there will be no compensation offered in the case of unsuccessful recording of audio data or the loss of audio data due to any cause whatsoever.
- During recording, operation of this product may be slower.
- If you stop the engine or the ignition switch is turned off while recording a CD, there may be pauses between songs when you play back from the HDD.
- Tracks from music CDs are recorded at 6 times the playback speed. You can listen to tracks as they are being recorded.
- Skip up/down, forward/rewind, repeat, random and scan functions are not available during recording.

CONTINUED

Playing Hard Disc Drive (HDD) Audio (Models with navigation system)

- You can listen to tracks from other playlists that have already been recorded while recording. Press the HDD button and switch over to HDD Audio.
- With the factory settings, all of the songs on a music CD are automatically recorded.
- Recording settings cannot be changed during recording.
- If the number of songs in the playlist exceeds 999, the oldest song will be overwritten each time you add a new song.

To Cancel Recording a Music CD to HDD

In order to suspend recording, push the interface selector down, select Cancel Rec to HDD, and press ENTER on the interface selector.

Changing the Recording Settings *Recording a Track on a Music CD Manually*

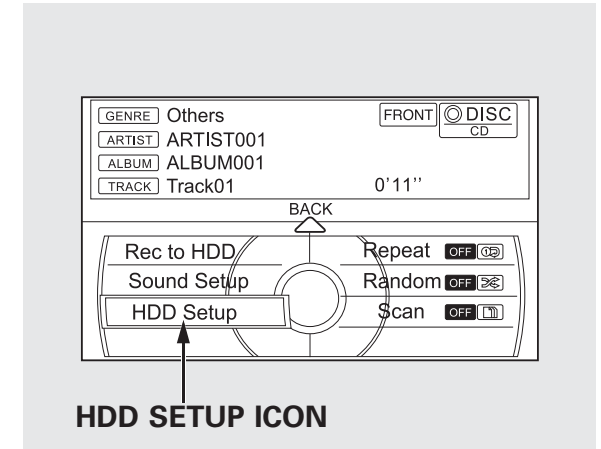

To change the setting to manual mode, push the interface selector down on the HDD screen. Turn the interface dial to select HDD Setup and press ENTER on the interface selector. Turn the interface dial to select Ripping, and press ENTER on the interface selector.

Playing Hard Disc Drive (HDD) Audio (Models with navigation system)

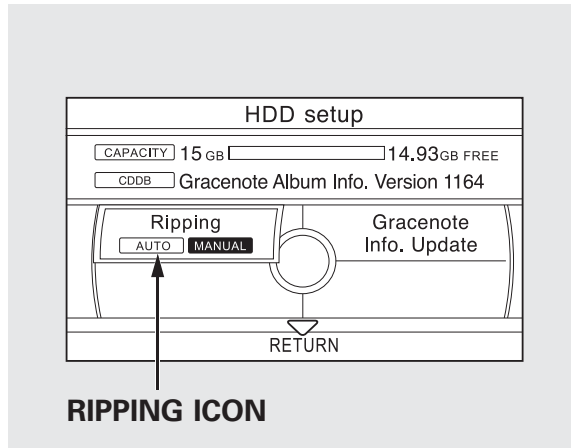

RIPPING ICON

Turn the interface dial to select **MANUAL** and press **ENTER** on the interface selector.

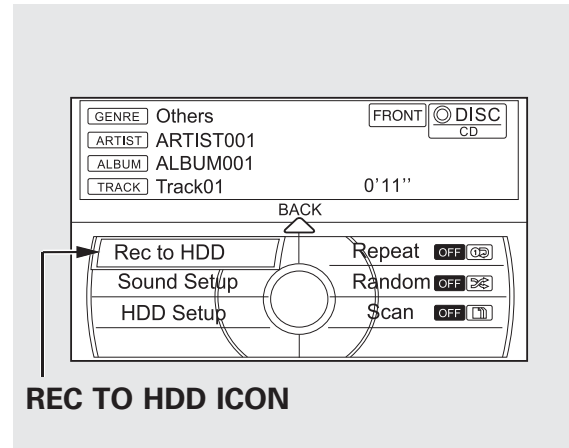

REC TO HDD ICON

Select a track to record from the CD. Push the interface selector down to display the audio menu. Turn the interface dial to select **Rec to HDD**, and then press **ENTER** on the interface selector.

Recording All of the Tracks on a Music CD Automatically

To change the setting to automatically record all of the tracks on a music CD, move the interface selector down on the HDD Audio screen. Turn the interface dial to select **HDD Setup**, and press **ENTER** on the interface selector.

Turn the interface selector to select **Ripping**, and press **ENTER** on the interface selector.

Turn the interface dial to select **AUTO**, and press **ENTER** on the interface selector.

CONTINUED



Playing Hard Disc Drive (HDD) Audio (Models with navigation system)

Playing Tracks on HDD

To play tracks on HDD, push the HDD button until the HDD Audio screen appears. Playback will start automatically with the track previously selected.

Changing a track/track list

To select tracks, press the Skip button.

Skip button	
	Returns to the beginning of the song that is being played. Otherwise, the previous track is selected. If you press this button during the first song, the last song is selected.
	The next song is selected. If you press this button during the last song, the first song is selected.

Repeat Playback

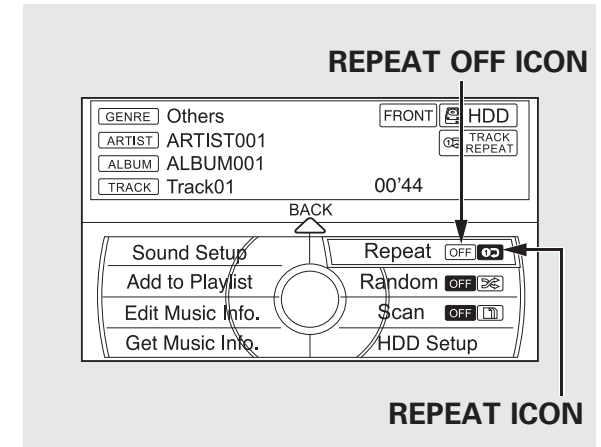

To replay the current track continuously, press the RPT button, or push the interface selector down during track playback.

Turn the interface dial to select Repeat on the HDD AUDIO MENU, and press ENTER on the interface selector. Turn the interface dial to select the repeat icon, then press ENTER on the interface selector.

Playing Hard Disc Drive (HDD) Audio (Models with navigation system)

To turn this feature off, turn the interface dial to select the OFF icon, then press ENTER on the interface selector.

Random Playback

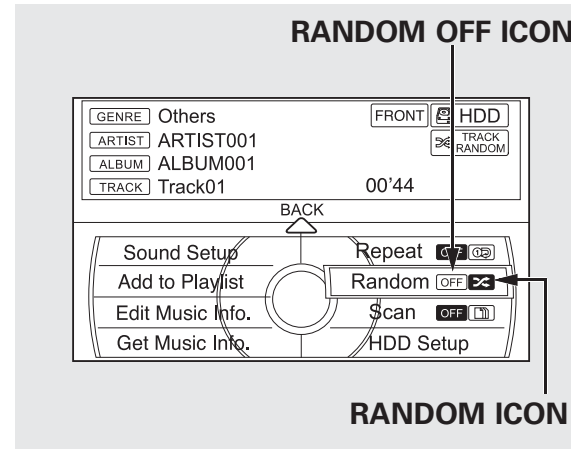

This function plays tracks in the current mode in random order. To activate random play, press the RDM button, or push the interface selector down during track playback. Turn the interface dial to select Random on the HDD AUDIO MENU. Press ENTER on the interface selector.

Turn the interface dial to select the track random icon, and press ENTER on the interface selector.

To turn this feature off, turn the interface dial to select the OFF icon, then press ENTER on the interface selector.

CONTINUED

Playing Hard Disc Drive (HDD) Audio (Models with navigation system)

Scan Playback

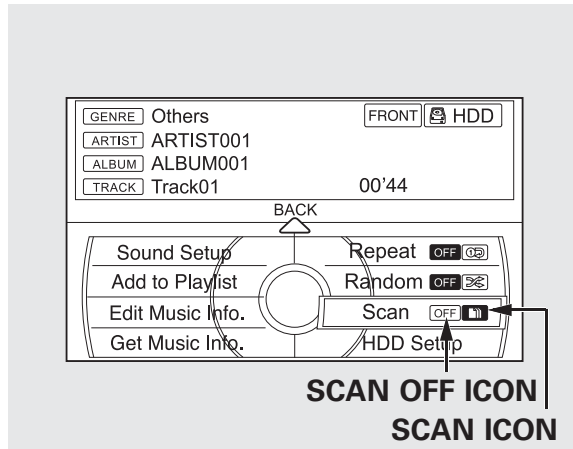

This function samples the tracks in the current search mode in the order that they were recorded.

To activate scan, press the SCAN button, or push the interface selector down during track playback. Turn the interface dial to select Scan on the HDD AUDIO MENU, and press ENTER on the interface selector.

Turn the interface dial to select the scan icon. Press ENTER on the interface selector. You will hear a 10-second sampling of each track in the current search mode.

To turn this feature off, turn the interface dial to select the OFF icon, then press ENTER.

Searching the Music

While playing music in the HDD playback screen, push the interface selector up to select MUSIC SEARCH. You can search a track by album, artist, track, playlist, genre, or ripped date, or you can shuffle all tracks.

The voice command music search feature, Song By Voice™, is also available. Refer to the navigation system manual for complete details.

Playing Hard Disc Drive (HDD) Audio (Models with navigation system)

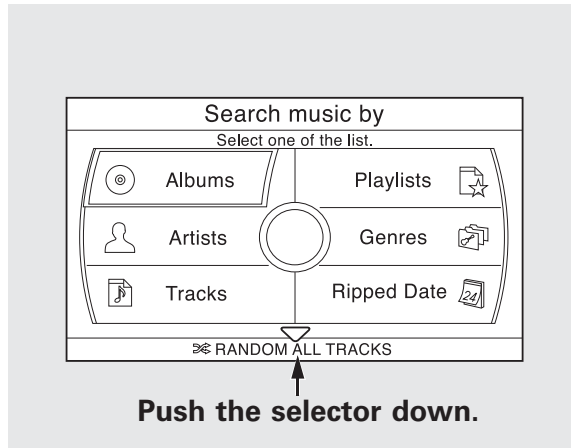

RANDOM ALL TRACKS

Shuffles the playback of all tracks that have been recorded on HDD.

To random all tracks, push the interface selector up to display the Search music by screen, and then push the interface selector down. All tracks are played randomly.

Searching Music by Album

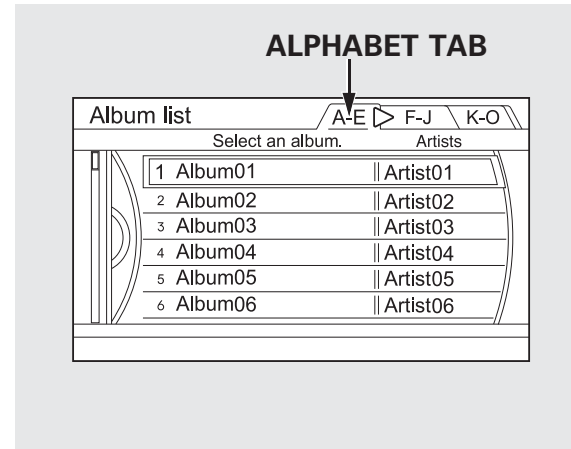

Push the interface selector up to display the Search music by screen, and turn the interface dial to select Albums. Press ENTER on the selector, and the album list will be displayed in alphabetical order.

If you push the interface selector right or left, you can change the alphabet tab.

Turn the interface dial to select the album you want to listen to, then press ENTER on the selector.

The first track on the selected album begins to play.

Playing Hard Disc Drive (HDD) Audio (Models with navigation system)

Searching Music by Artist

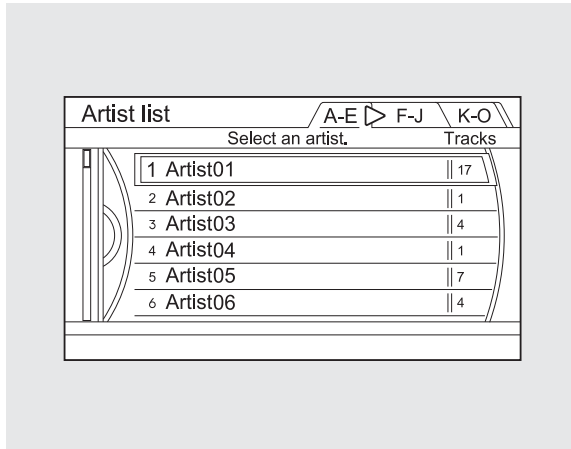

Push the interface selector up to display the Search music by screen, and turn the interface dial to select Artists. Press ENTER on the interface selector, and the artist list will be displayed in alphabetical order.

If you push the interface selector right or left, you can change the alphabet tab.

Turn the interface dial to select the artist you want to listen to, and press ENTER on the interface selector.

The first track on the selected artist begins to play.

Searching Music by Track

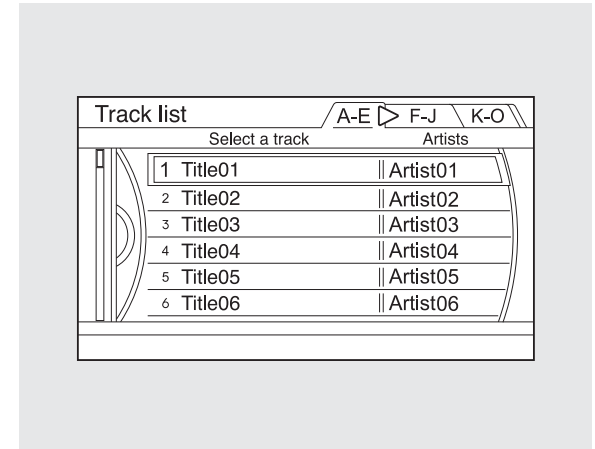

Push the interface selector up to display the Search music by screen, and turn the interface dial to select Tracks. Press ENTER on the interface selector, and the track list will be displayed in alphabetical order.

If you push the interface selector right or left, you can change the alphabet tab.

Playing Hard Disc Drive (HDD) Audio (Models with navigation system)

Turn the interface dial to select a track you want to listen to, then press ENTER on the interface selector.

The selected track begins to play.

Searching Music by Playlists

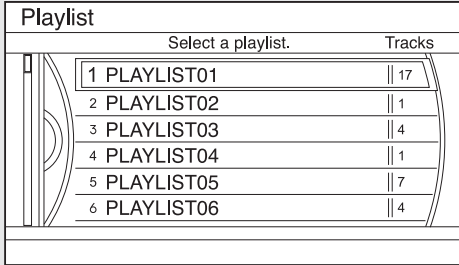

Playlist	
Select a playlist.	Tracks
1 PLAYLIST01	17
2 PLAYLIST02	1
3 PLAYLIST03	4
4 PLAYLIST04	1
5 PLAYLIST05	7
6 PLAYLIST06	4

Push the interface selector up to display the Search music by screen, and turn the interface dial to select Playlists. Press ENTER on the interface selector then the playlist will be displayed.

Turn the interface dial to select the playlist you want to listen to, then press ENTER on the interface selector.

The first track on the selected playlist begins to play.

Playing Hard Disc Drive (HDD) Audio (Models with navigation system)

Searching Music by Genre

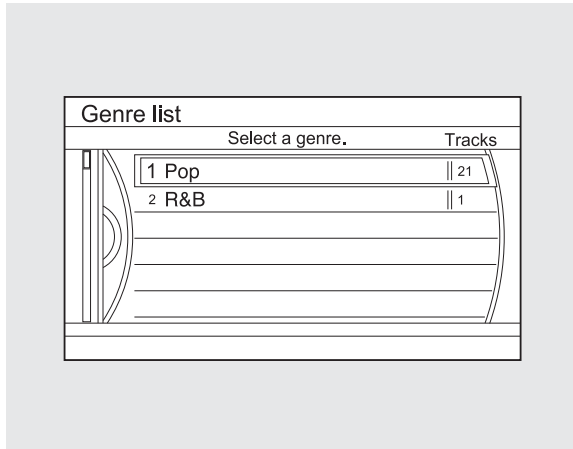

Push the interface selector up to display the Search music by screen, and turn the interface dial to select Genres. Press ENTER on the interface selector, and the genre list will be displayed.

Turn the interface dial to select the genre you want to listen to, and then press ENTER on the interface selector.

The first track on the selected genre begins to play.

Searching Music by Ripped Date

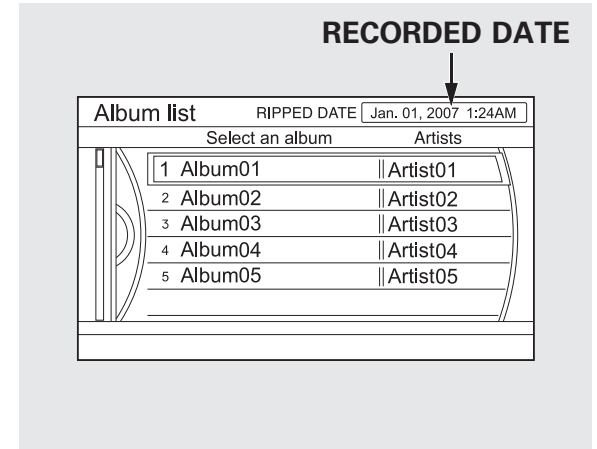

Push the interface selector up to display the Search music by screen, and turn the interface dial to select Ripped Date. Press ENTER on the interface selector. The album list will be displayed.

Turn the interface dial to select the album you want to listen to, then press ENTER on the selector.

The first track on the selected album begins to play.

Playing Hard Disc Drive (HDD) Audio (Models with navigation system)

Customizing Original/User Playlist

The HDD has two types of the playlists: original playlist and user playlist. On the original playlist, the music CD is recorded automatically when it is played. In addition, you can create up to six user playlists on the HDD. In each playlist, you can store a desired music data from the original playlists or music CDs.

After storing the data, you can change some items: order of tracks on the user playlist, name of the playlist, track title, artist name, and music genre. You can also add a track to the playlist, and delete the track or the album from the playlist.

Changing the Order of Tracks Within the User Playlist

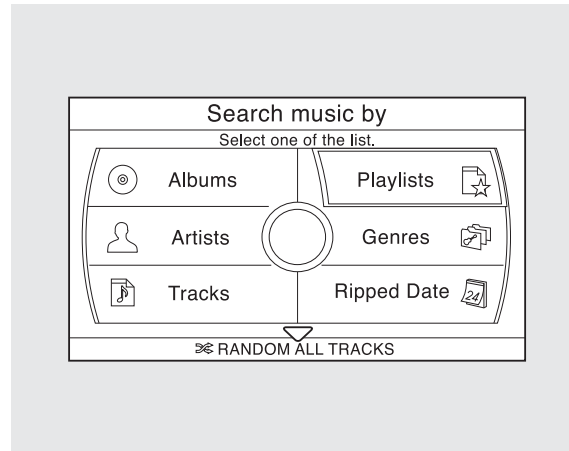

1. On the HDD audio screen, push up the interface selector to select MUSIC SEARCH. Select Playlists by turning the interface dial, then press ENTER on the interface selector.

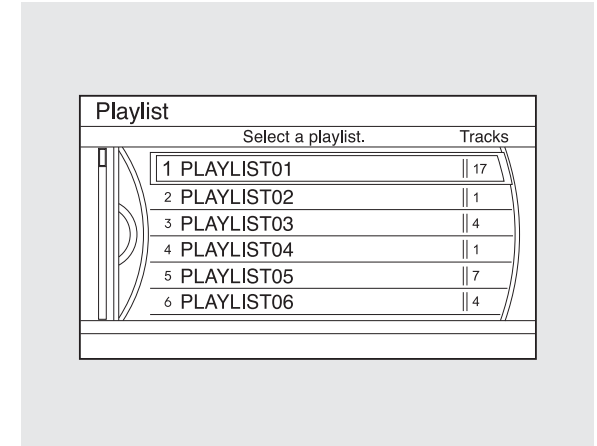

2. Turn the interface dial to select the playlist, then press ENTER.
3. Push the interface selector down to display the AUDIO MENU for the playlist.

CONTINUED

Playing Hard Disc Drive (HDD) Audio (Models with navigation system)

4. Turn the interface dial and select Edit Music Info, then press ENTER on the interface selector.
5. Turn the interface dial to select Edit Track Order, then press ENTER on the interface selector.
6. Turn the interface dial to select the track to be moved, then press ENTER on the interface selector.

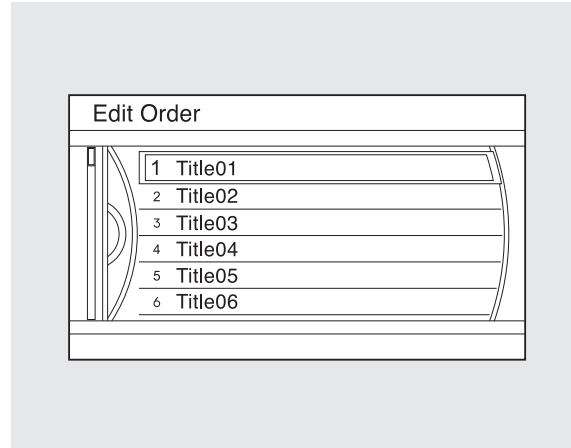

7. Turn the interface dial to select where the track is to be moved, then press ENTER on the interface selector.
8. Push the interface selector down to return to the Playback screen of the User Playlist.

Changing the Name of the Original Playlist

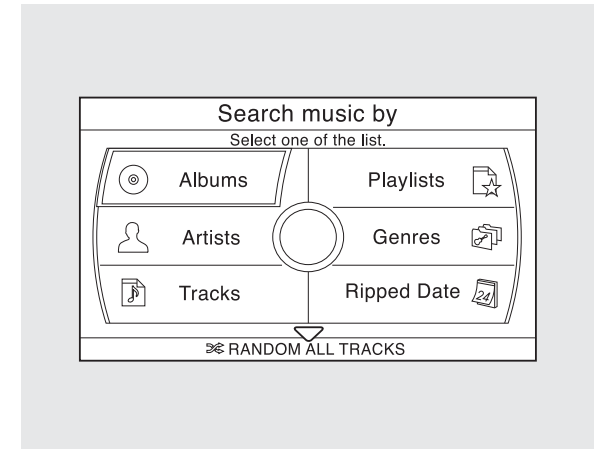

1. Select a desired playlist to change the original playlist name (album name). Refer to the Music Search function on page 258 for how to select an album. Push the interface selector down to display AUDIO MENU for a selected album.

Playing Hard Disc Drive (HDD) Audio (Models with navigation system)

2. Turn the interface dial and select Edit Music Info, then press ENTER on the interface selector.
3. Turn the interface dial to select Edit Album Name, then press ENTER on the interface selector.
4. On the Edit Album Name screen, turn the interface dial to select Edit Album, then press ENTER on the interface selector.

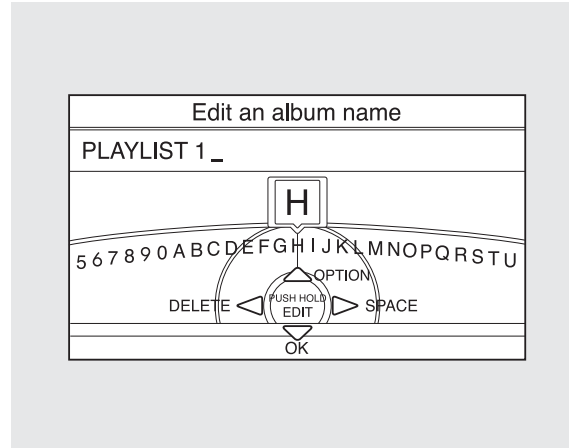

5. On the Enter an album name screen, input the new Original Playlist name.

Select a letter by turning the interface dial, then press ENTER on the interface selector.

6. After inputting the name, push the interface selector down to select OK. The screen returns to the Edit Music Info screen.
7. The display returns to the Playlist screen where you can confirm the changes.

CONTINUED

Playing Hard Disc Drive (HDD) Audio (Models with navigation system)

Changing the Track Titles

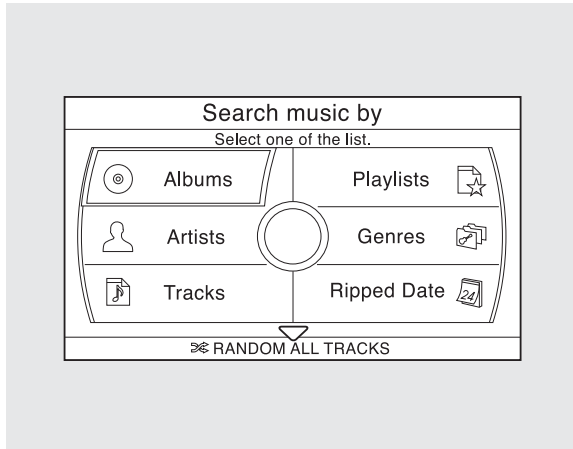

1. Select a desired original playlist, then turn the interface dial to select the track of which you want to change the name, then press ENTER on the interface selector. Refer to the Music Search function on page 258 for how to select a playlist. Push the interface selector down to display AUDIO MENU for a selected Album.

2. Turn the interface dial and select Edit Music Info, then press ENTER on the interface selector.

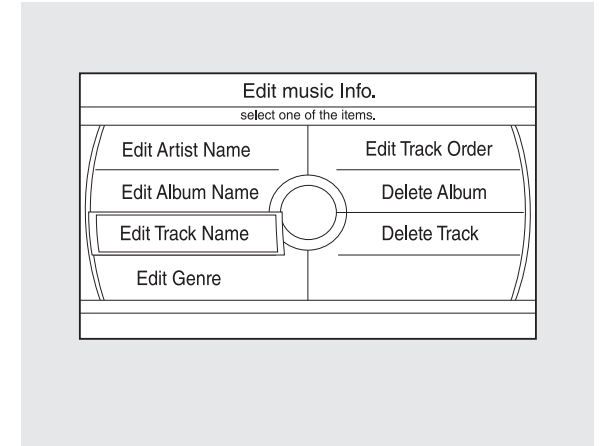

3. Turn the interface dial to select Edit Track Name, then press ENTER on the interface selector.

4. On the Edit Track screen, turn the interface dial and select Edit Track Name, then press ENTER on the interface selector.

Playing Hard Disc Drive (HDD) Audio (Models with navigation system)

5. On the Edit Track Name screen, input the new track name on the Enter a track name screen.
6. After inputting the name, push the selector down to select OK. The screen returns to the Edit Music Info screen.
7. The display returns to the Playlist screen where you can confirm the changes.

NOTE:

After selecting the track for which you want to change the track title, you can also push the interface selector down to display the AUDIO MENU, and then select Edit Track. The subsequent procedure is the same as step 4.

Changing the Artist Name of the Original Playlist and User Playlist

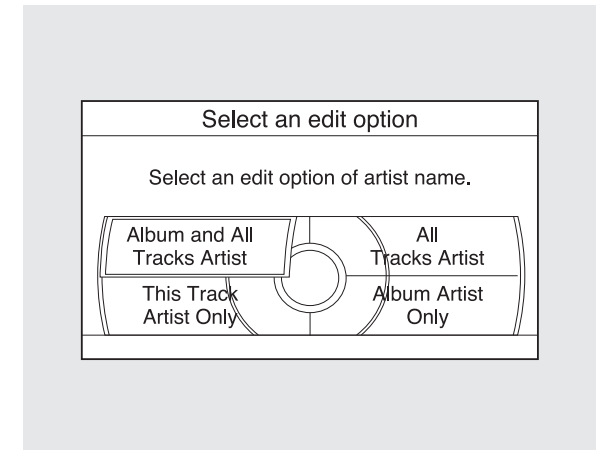

You can change the artist name displayed in the original playlist and User Playlist using the four icons in the Edit option screen.

Album and All Tracks Artist – Enables you to change the artist name of the selected album and all the tracks in the selected album.

CONTINUED

Playing Hard Disc Drive (HDD) Audio (Models with navigation system)

All Tracks Artist –

Enables you to change the artist name of all the tracks in the selected album.

Album Artist Only –

You can change the artist name of the selected album.

This Track Artist Only –

You can change the artist name of the selected track.

NOTE:

When you change the artist name from the Original Playlist, the artist name is also changed in the User Playlist in which the changed was stored. You cannot change the artist name from the User Playlist.

Changing the Artist Name of the Album or Track

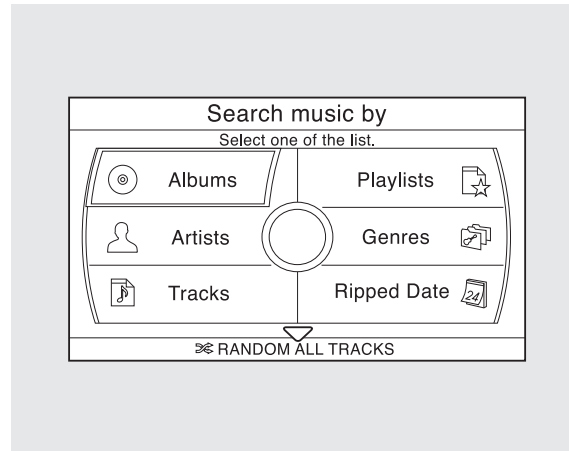

1. Select the playlist whose artist name you want to change (album and track artist name). Refer to the Music Search function on page 258 for how to select an album. Push the interface selector down to display AUDIO MENU for a selected album.
2. Turn the interface dial and select Edit Music Info, then press ENTER on the interface selector.

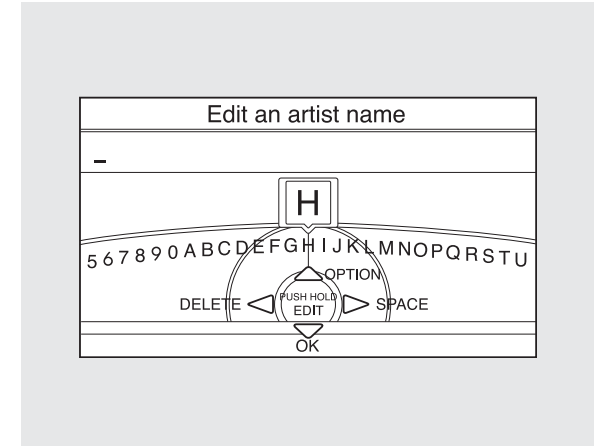

3. Turn the interface dial to select Edit Artist Name, then press ENTER on the interface selector.
4. On the Enter an artist name screen, input the new artist name.
5. Select a letter by turning the interface dial, then press ENTER on the interface selector.
6. After inputting the artist name, push the interface selector down to select OK. The screen returns to the Edit option screen.

Playing Hard Disc Drive (HDD) Audio (Models with navigation system)

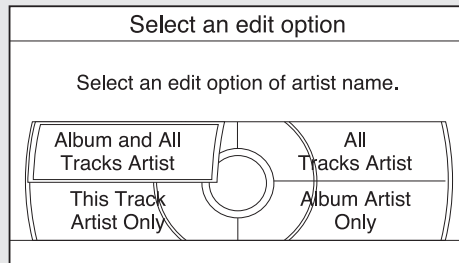

7. On the Edit option screen, turn the interface dial to select the desired icon, then press ENTER on the interface selector.
8. The display returns to the Playlist screen where you can confirm the changes.

Changing the Musical Genre

1. Select a desired playlist to change the user playlist music genre, or a desired album to change the original playlist music genre. Refer to the Music Search function on page 258 for how to select a playlist or an album. Push the interface selector down to display AUDIO MENU for a selected playlist or album.

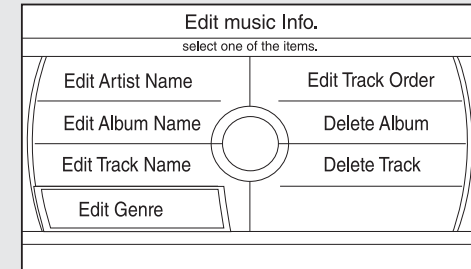

2. Turn the interface dial and select Edit Music Info, then press ENTER on the interface selector.
3. Turn the interface dial to select Edit Genre, then press ENTER on the interface selector.

CONTINUED

Playing Hard Disc Drive (HDD) Audio (Models with navigation system)

4. Select a genre, turn the interface dial to select a genre and then press ENTER. You will be returned to the Edit Music Info screen.

Deleting a Track

1. Select the track with the interface dial from the playback screen while it is playing. Push the interface selector down to display AUDIO MENU.
2. Turn the interface dial and select Edit Music Info, then press ENTER on the interface selector.
3. Turn the interface dial to select Delete Track, then press ENTER on the interface selector.

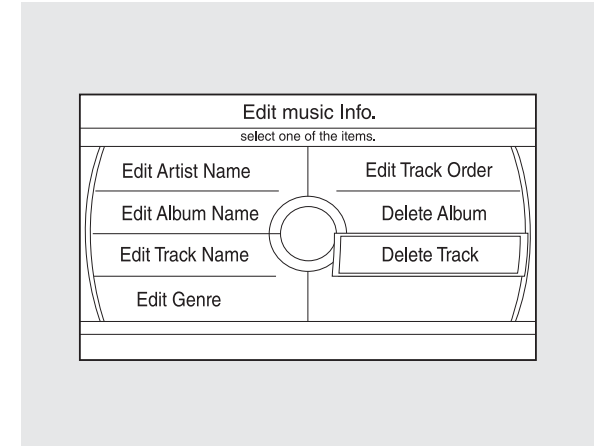

4. On the Track list screen, turn the interface dial and select the track. Then press ENTER on the interface selector.
5. Select OK to confirm you want to delete the track.

Playing Hard Disc Drive (HDD) Audio (Models with navigation system)

NOTE:

- When you delete a track from the Original Playlist, the track is also deleted from the User Playlist in which the deleted track was stored.
- Even if all the tracks are deleted from the User Playlist, the data folder for that playlist cannot be deleted, and their names (playlist and artist) are left. You can store tracks again on that playlist.

Deleting a Playlist

1. On the HDD playback screen of the album in which you want to delete, push the interface selector down to display AUDIO MENU.
2. Turn the interface dial and select Edit Music Info, then press ENTER on the interface selector.
3. Turn the interface dial to select Delete Album, then press ENTER on the interface selector.

4. On the Album list screen, turn the interface dial and select the Album. Then press ENTER on the interface selector. Select OK to confirm you want to delete the Album.

NOTE:

- When you delete the Original Playlist, any tracks stored in a User Playlist are also deleted.
- Even if all the tracks are deleted from the User Playlist, the data folder for that playlist cannot be deleted, and their names (playlist and artist) are left. You can store tracks again on that playlist.

CONTINUED

Playing Hard Disc Drive (HDD) Audio (Models with navigation system)

Adding a Track to a User Playlist

1. While a track is playing on an Original Playlist or User Playlist Playback screen, turn the interface dial and select the track that you want to add to a User Playlist, then press ENTER on the interface selector.

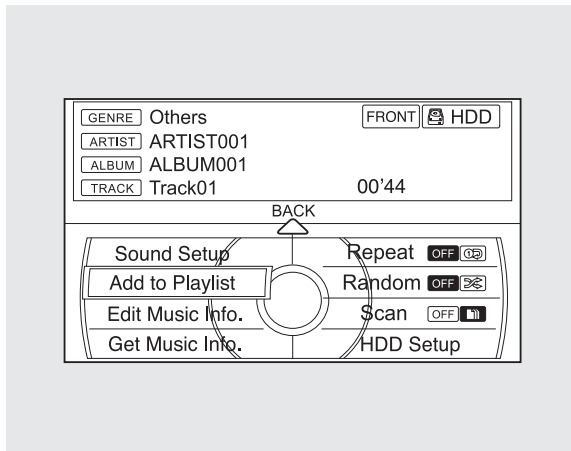

2. Push the interface selector down to display AUDIO MENU. Select Add to Playlist, then press ENTER on the interface selector.

3. On the Playlist screen, turn the interface dial and select the Playlist to which the song is to be added, then press ENTER on the interface selector.

NOTE:

When adding from and to the same User Playlist, the same tracks will be stored twice.

Acquiring Title Information

1. Push the interface selector down to display AUDIO MENU.
2. Turn the interface dial and select Get Music Info, then press ENTER on the interface selector.
3. On the Select an Album screen, turn the interface dial and select the title information for the Original Playlist, then press ENTER on the interface selector. You will be returned to the Audio Menu screen.

Playing Hard Disc Drive (HDD) Audio (Models with navigation system)

Checking HDD Audio Capacity

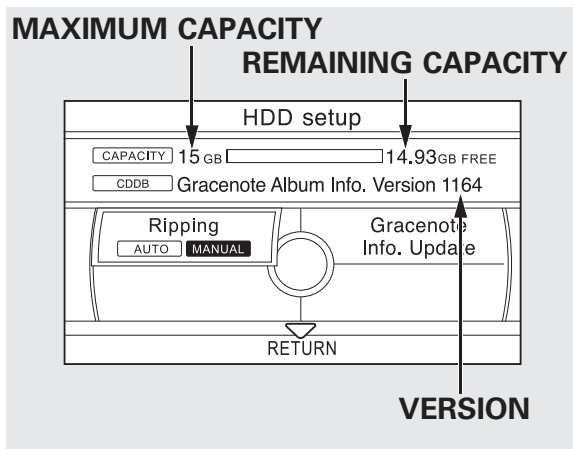

You can check the HDD Audio capacity and remaining space as well as the Gracenote Music Recognition Service (CDDDB) version included with the navigation system on the HDD Setup screen.

Updating Gracenote® Album Info (Gracenote® Media Database)

You can update the Gracenote® Album Info (Gracenote® Media Database) that is included with the navigation system.

NOTE:

Consult your dealer, or visit www.acura.com (in U.S.), or www.acura.ca (in Canada), to acquire updated files.

1. Insert the update disc into the disc slot, or connect the USB flash memory device that includes the update.

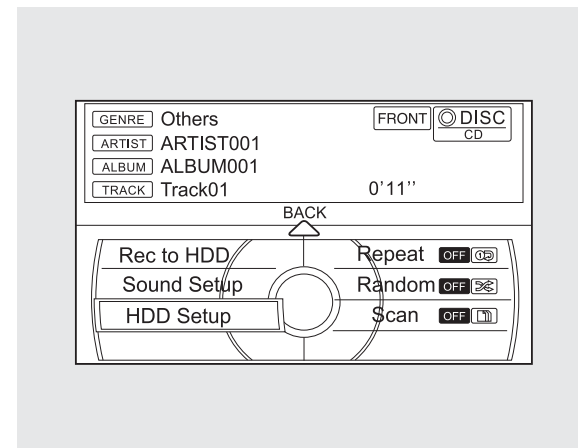

2. Push the interface selector down to select AUDIO MENU in the HDD playback screen or CD playback screen.
3. Turn the interface dial to select HDD Setup, then press ENTER on the interface selector.

CONTINUED

Playing Hard Disc Drive (HDD) Audio (Models with navigation system)

4. Turn the interface dial and select Gracenote Info. Update, then press ENTER on the interface selector.
5. Turn the interface dial to select USB or DISC on the Update Gracenote Album info screen, then press ENTER on the interface selector.
6. Turn the dial to select Yes on the confirmation screen, and the update will start.
7. Turn the interface dial to select OK on the confirmation screen.
8. After updating is complete, press ENTER on the confirmation screen.

NOTE:

Once you perform an update any information you edited before will be overwritten.

Clearing the HDD

Any music, data, calendar entries, etc. that have been stored on the HDD can be deleted.

1. Press the INFO button, rotate the interface dial to select **Set up**, and press ENTER on the interface selector.
2. Move the interface selector to the right to navigate to the **Set up (Other)** tab.
3. On the **Set up (Other)** search, rotate the interface dial to select **Clear Personal Data**, and press ENTER on the interface selector.
4. Select the item you wish to delete.

5. A second confirmation will appear. Select Yes to delete, or No to cancel.

NOTE: If you select **Music on HDD**, the system will automatically restart after deletion.

Playing Hard Disc Drive (HDD) Audio (Models with navigation system)

Gracenote Music Recognition Service (CDDB)



Music recognition technology and related data are provided by Gracenote®. Gracenote is the industry standard in music recognition technology and related content delivery. For more information, please visit <http://www.gracenote.com/>.

When music is recorded to the HDD from a CD, information such as the recording artist and track name are retrieved from the Gracenote Database and displayed (when available). Gracenote may not contain information for all albums.

Gracenote is an internet-based music recognition service that allows artist, album, and track information from CDs to display on the HDD. Gracenote users are allowed 4 free updates a year. More information about Gracenote, its features, and downloads are available at www.acura.com (in U.S.) or www.acura.ca (in Canada).

CD and music-related data from Gracenote, Inc., copyright© 2000 – 2010 Gracenote.

Gracenote Software, copyright© 2000 – 2010 Gracenote. This product and service may practice one or more of the following U.S. Patents: # 5,987,525; # 6,061,680; # 6,154,773, # 6,161,132, # 6,230,192, # 6,230,207, # 6,240,459, # 6,330,593, and other patents issued or pending. Some services supplied under license from Open Globe, Inc. for U. S. Patent: # 6,304,523.

Gracenote and CDDB are registered trademarks of Gracenote. The Gracenote logo and logotype, and the “Powered by Gracenote” logo are trademarks of Gracenote.

CONTINUED

Playing Hard Disc Drive (HDD) Audio (Models with navigation system)

Gracenote® End User License Agreement

Version 20061005

This application or device contains software from Gracenote, Inc. of Emeryville, California (“Gracenote”). The software from Gracenote (the “Gracenote Software”) enables this application to perform disc and/or file identification and obtain music-related information, including name, artist, track, and title information (“Gracenote Data”) from online servers or embedded databases (collectively, “Gracenote Servers”) and to perform other functions. You may use Gracenote Data only by means of the intended End-User functions or this application or device.

You agree that you will use Gracenote Data, the Gracenote Software, and Gracenote Servers for your own personal non-commercial use only.

You agree not to assign, copy, transfer or transmit the Gracenote Software or any Gracenote Data to any third party.

YOU AGREE NOT TO USE OR EXPLOIT GRACENOTE DATA, THE GRACENOTE SOFTWARE, OR GRACENOTE SERVERS, EXCEPT AS EXPRESSLY PERMITTED HEREIN.

You agree that your non-exclusive license to use the Gracenote Data, the Gracenote Software, and Gracenote Servers will terminate if you violate these restrictions. If your license terminates, you agree to cease any and all use of the Gracenote Data, the Gracenote Software, and Gracenote Servers.

Gracenote reserves all rights in Gracenote Data, the Gracenote Software, and the Gracenote Servers, including all ownership rights. Under no circumstances will Gracenote become liable for any payment to you for any information that you provide. You agree that Gracenote, Inc. may enforce its rights under this Agreement against you directly in its own name.

The Gracenote service uses a unique identifier to track queries for statistical purposes. The purpose of a randomly assigned numeric identifier is to allow the Gracenote service to count queries without knowing anything about who you are. For more information, see the web page for the Gracenote Privacy Policy for the Gracenote service.

The Gracenote Software and each item of Gracenote Data are licensed to you “AS IS.”

Playing Hard Disc Drive (HDD) Audio (Models with navigation system)

Gracenote makes no representations or warranties, express or implied, regarding the accuracy of any Gracenote Data from in the Gracenote Servers. Gracenote reserves the right to delete data from the Gracenote Servers or to change data categories for any cause that Gracenote deems sufficient. No warranty is made that the Gracenote Software or Gracenote Servers are error-free or that functioning of Gracenote Software or Gracenote Servers will be uninterrupted.

Gracenote is not obligated to provide you with new enhanced or additional data types or categories that Gracenote may provide in the future and is free to discontinue its services at any time.

GRACENOTE DISCLAIMS ALL WARRANTIES EXPRESS OR IMPLIED, INCLUDING, BUT NOT LIMITED TO, IMPLIED WARRANTIES OF MERCHANTABILITY, FITNESS FOR A PARTICULAR PURPOSE, TITLE, AND NONINFRINGEMENT. GRACENOTE DOES NOT WARRANT THE RESULTS THAT WILL BE OBTAINED BY YOUR USE OF THE GRACENOTE SOFTWARE OR ANY GRACENOTE SERVER. IN NO CASE WILL GRACENOTE BE LIABLE FOR ANY CONSEQUENTIAL OR INCIDENTAL DAMAGES OR FOR ANY LOST PROFITS OR LOST REVENUES.
©Gracenote 2010

Playing an iPod® (Models with navigation system)

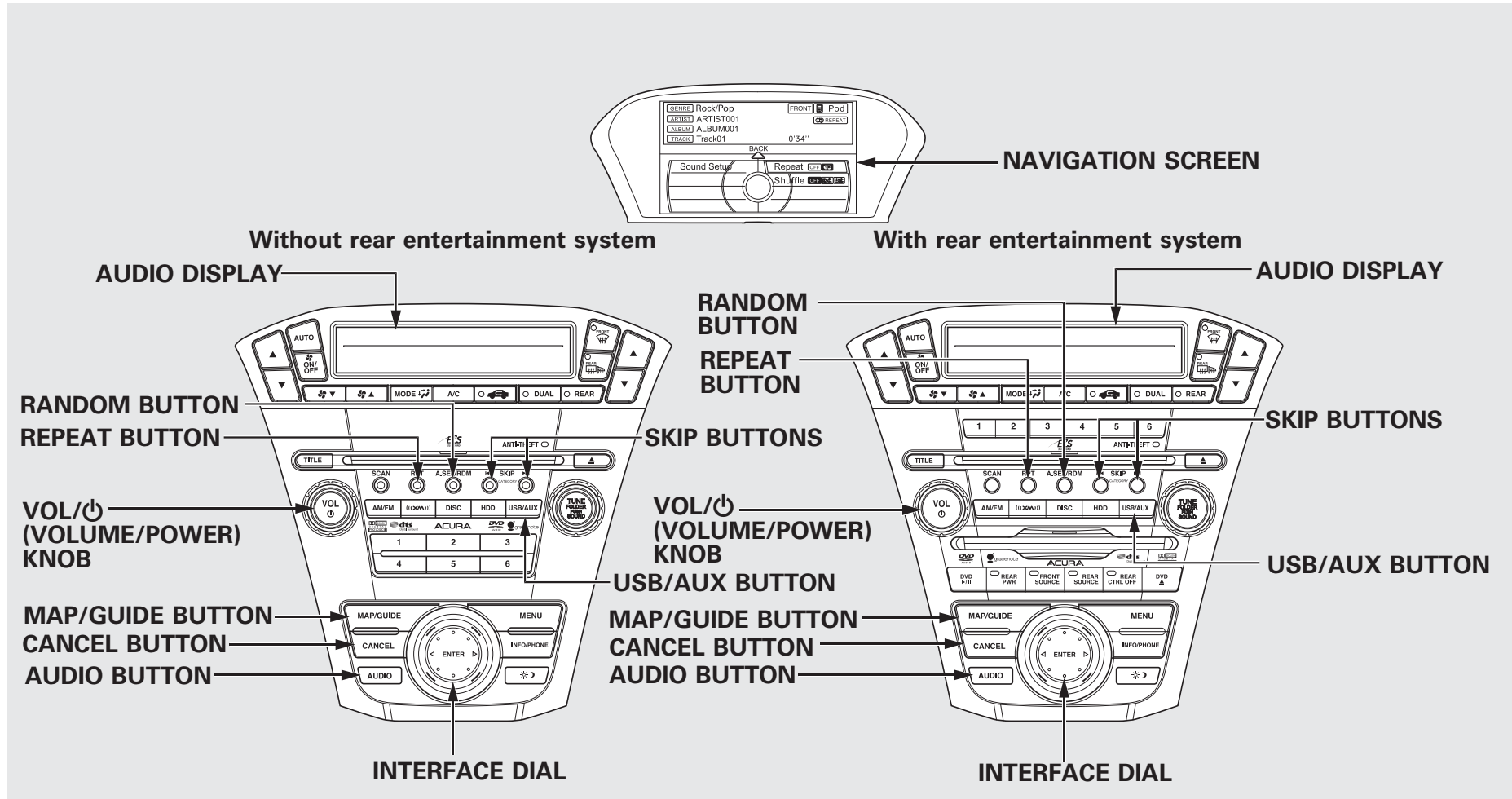

Playing an iPod® (Models with navigation system)

To Play an iPod®

This audio system can select and play the audio files on the iPod® with the same controls used for the in-dash disc player. To play an iPod, connect it to the USB adapter cable in the console compartment by using your dock connector, then press the USB/AUX button. The ignition switch must be in the ACCESSORY (I) or the ON (II) position. The iPod will also be charged with the ignition switch in these settings.

The audio system reads and plays sound files to be playable on the iPod. The system cannot operate an iPod as a mass storage device. The system will only play songs stored on the iPod with iTunes.

iPod and iTunes are registered trademarks owned by Apple Inc.

Voice Control System

You can select the AUX mode by using the navigation system voice control buttons, but cannot operate the play mode functions.

The voice command music search feature, Song By Voice™, is also available. Refer to the navigation system manual for complete details.

iPod models confirmed to be compatible with your audio system using the USB adapter cable are:

Model
iPod (5th generation)
iPod classic 80GB/160GB
iPod classic 120GB
iPod classic 160GB (launch in 2009)
iPod touch
iPod nano

This system may not work with all software versions of these devices.

CONTINUED

Playing an iPod® (Models with navigation system)

Use only compatible iPods with the latest software. iPods that are not compatible will not work in this audio unit.

NOTE:

- Do not connect your iPod using a hub.
- Do not keep the iPod and dock connector cable in the vehicle. Direct sunlight and high heat will damage it.
- Do not use an extension cable between the USB adapter cable equipped with your vehicle and your dock connector.
- We recommend backing up your data before playing it.
- Some devices cannot be powered or charged via the USB adapter, if this is the case use the accessory adapter to supply power to your device.

Connecting an iPod

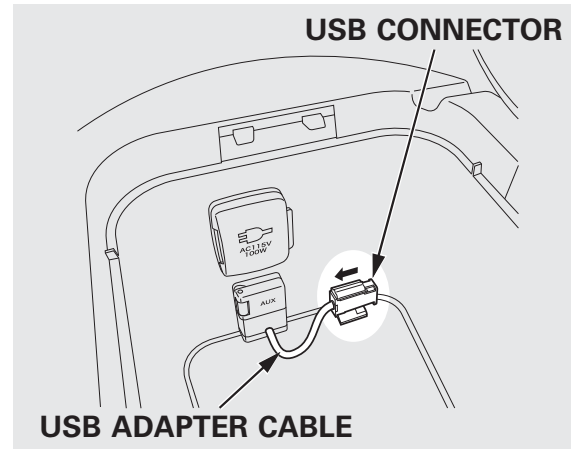

1. Unclip the USB connector by pulling it up, and pull out the USB adapter cable in the console compartment.

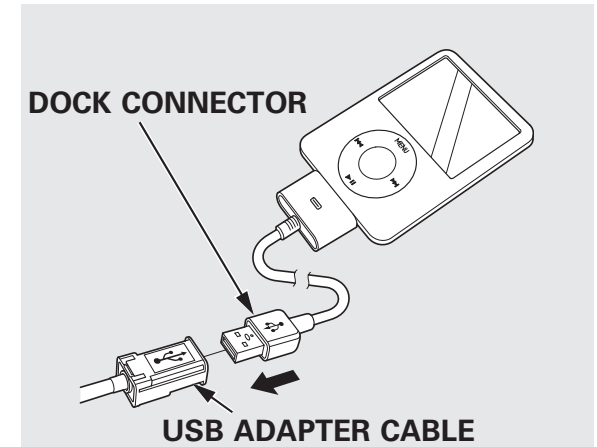

2. Connect your dock connector to the iPod correctly and securely.
3. Install the dock connector to the USB adapter cable securely.

Playing an iPod® (Models with navigation system)

If the iPod indicator does not appear in the audio display, check the connections, and try to reconnect the iPod a few times.

If the audio system still does not recognize the iPod, the iPod may need to be reset. Follow the instructions that came with your iPod, or you can find reset instructions online at www.apple.com/ipod.

The current file number and total of the selected playable files are displayed in the center display. Pressing the AUDIO button displays the artist, album and track (file) names on the navigation screen.

To Change or Select Files

Use the SKIP button an iPod is playing to select passages and change files.

SKIP – Each time you press and release the ►►| side of the SKIP button, the system skips forward to the beginning of the next track. Press and release the |◄◄ side of the button to skip backward to the beginning of the current track. Press it again to skip to the beginning of the previous track.

To move rapidly within playing track, press and hold either side (►►| or |◄◄) of the SKIP button.

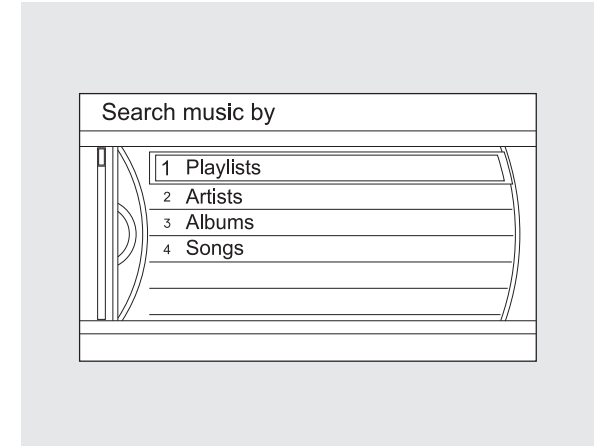

You can also select a track from any category on the list: playlists, artists, albums and songs, by using the interface dial.

Push the interface selector up to display the Music Search screen. Turn the interface dial to select a desired search method.

CONTINUED

Playing an iPod® (Models with navigation system)

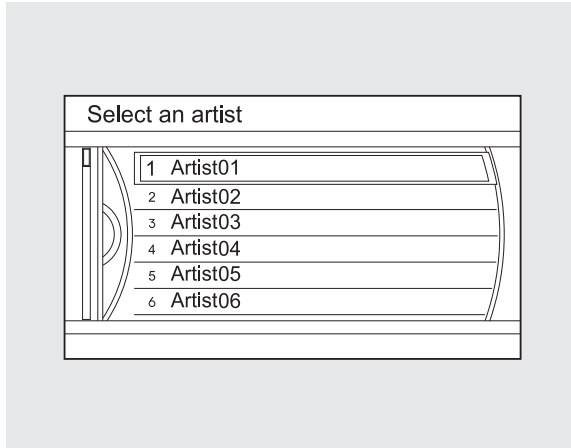

Press ENTER on the interface selector to display the items on that list, then turn the interface dial to make a selection. Press ENTER to set your selection.

If you select “ALL” on the artists list, the albums list is displayed.

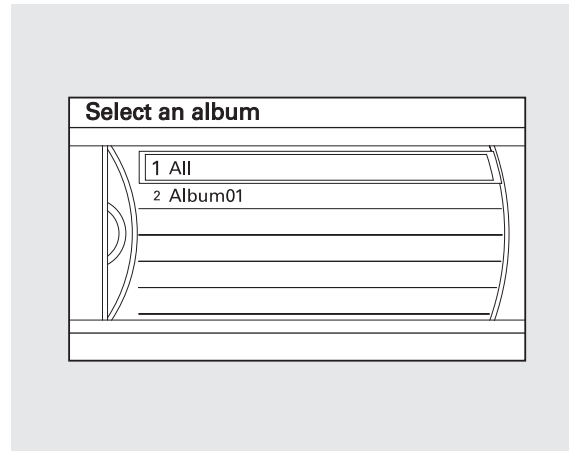

If you select “ALL” on the albums list, all the tracks become available for selection.

The track order that appears at this time varies depending on the iPod model and software.

Press the AUDIO button to go back to the normal audio playing display. Pressing the CANCEL button goes back to the previous screen, and pressing the MAP/GUIDE button cancels the audio control display on the screen.

Playing an iPod® (Models with navigation system)

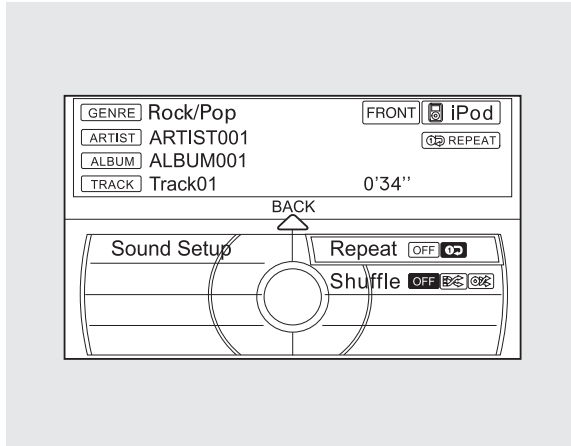

REPEAT – This feature continuously plays a file.

1. Press the AUDIO button to display the audio control screen, then push the interface selector down to display AUDIO MENU.
2. Turn the interface dial, select Repeat, and press ENTER on the interface selector.

3. Turn the interface dial, select the Repeat icon and press ENTER on the interface selector. Playback of the track that is currently being played will be repeated.

To cancel this function, turn the interface dial and select the Repeat OFF icon, and then press ENTER on the interface selector.

You can also select the function by using the RPT button.

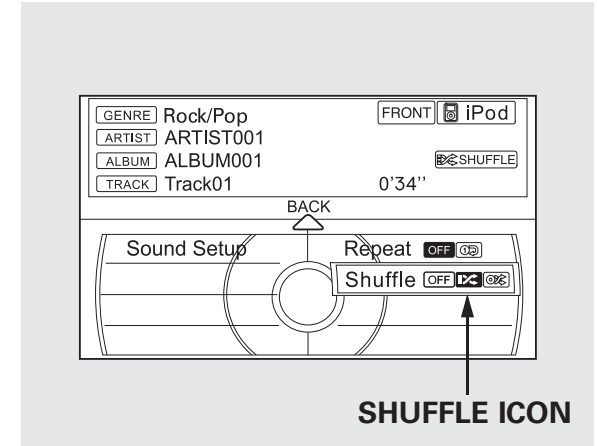

SHUFFLE – This feature shuffles playback of tracks contained within the iPod. This function can be established at the same time that Repeat Playback is set up.

1. On the iPod screen, push the interface selector down to display AUDIO MENU.

CONTINUED

Playing an iPod® (Models with navigation system)

2. Turn the interface dial, select Shuffle and press ENTER on the interface selector.
3. Turn the interface dial, select the Shuffle icon and press ENTER on the interface selector.

Shuffle playback will begin. To cancel this function, turn the interface dial and select the Shuffle OFF icon, and then press ENTER on the interface selector.

You can also select the function by using the RDM button.

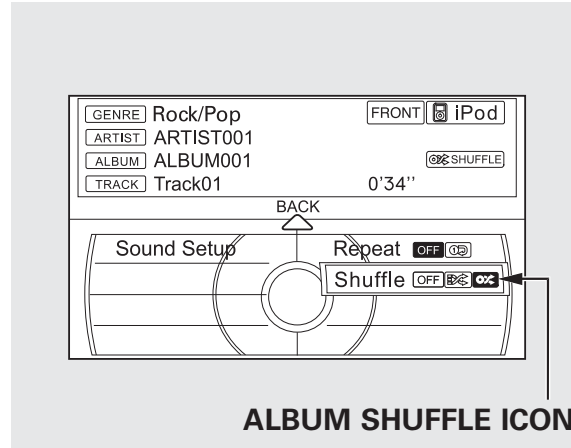

ALBUM SHUFFLE – Shuffles playback of all available albums, which are selected by the desired list: playlists, artists, albums or songs. This function can be selected at the same time that Repeat Playback is setup.

1. On the iPod screen, push the interface selector down to display AUDIO MENU.

2. Turn the interface dial, select Shuffle and press ENTER on the interface selector.
3. Turn the interface dial, select the Album Shuffle icon and press ENTER on the interface selector. Shuffle playback of the album will begin.

To cancel this function, turn the interface dial and select the Shuffle OFF icon, and then press ENTER on the interface selector.

NOTE:

Available operating functions vary on models or versions. Some functions may not be available on the vehicle's audio system.

Playing an iPod® (Models with navigation system)

To Stop Playing Your iPod®

To play the radio, press the AM/FM, or XM button. Press the DISC button to switch to the disc mode. Press the HDD button to switch to HDD Audio and press the USB/AUX button to switch to *Bluetooth*® Audio.

Disconnecting an iPod®

You can disconnect the iPod at any time when you see the “OK to disconnect” message* in the iPod display. Always make sure you see the “OK to disconnect” message in the iPod display before you disconnect it. Make sure to follow the iPod’s instructions on how to disconnect the dock connector from the USB adapter cable.

*: The displayed message may vary on models or versions. On some models, there is no message to disconnect.

When you disconnect the iPod while it is playing, the audio display and the navigation screen (if selected) show USB NO DATA.

If you reconnect the same iPod, the system may begin playing where it left off, depending on what mode the iPod is in when it is reconnected.

NOTICE

When you connect your iPod to the navigation system, the most recent settings (Shuffle, Repeat, etc.) will be carried over.

iPod® Error Messages

If you see an error message in the audio display, see page 286.

iPod® Error Messages (Models with navigation system)

If you see an error message in the audio display while playing an iPod, find the solution in the chart to the right. If you cannot clear the error message, take your vehicle to your dealer.

Error Message	Solution
UNSUPPORTED	Appears when an unsupported iPod is connected.
CONNECT RETRY	Appears when the iPod cannot be authenticated.
NO SONG	Appears when there are no files in the iPod.

Playing a USB Flash Memory Device (Models with navigation system)

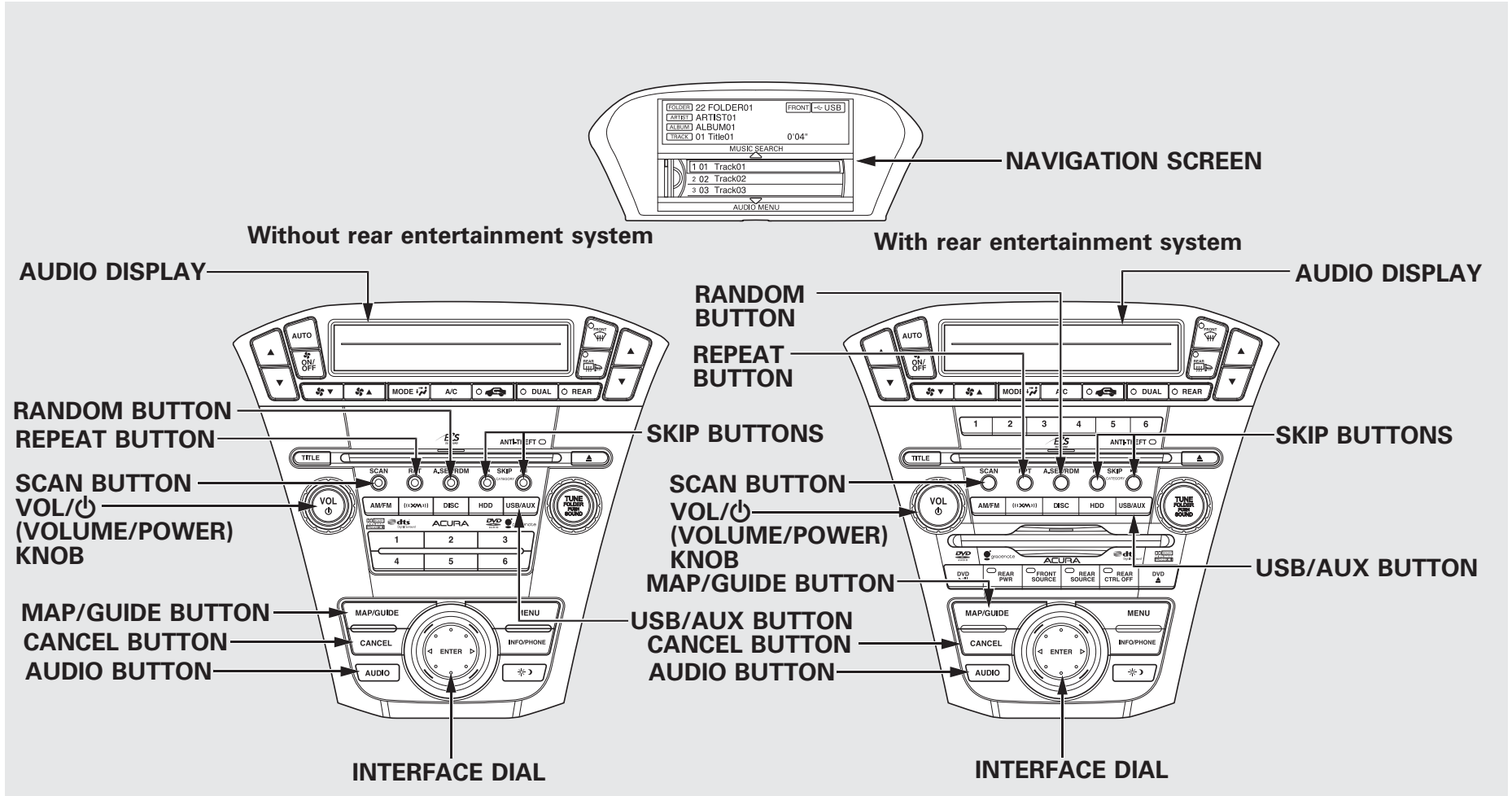

Features

CONTINUED

Playing a USB Flash Memory Device (Models with navigation system)

To Play a USB Flash Memory Device

This audio system can select and play the audio files on a USB flash memory device with the same controls used for the disc player. To play a USB flash memory device, connect it to the USB adapter cable in the console compartment, then press the USB/AUX button until you see “USB” in the display. The ignition switch must be in ACCESSORY (I) or ON (II) position.

The audio system reads and plays the audio files on the USB flash memory device in MP3, WMA or ACC* formats.

* : Only AAC format files recorded with iTunes are playable on this audio unit.

The recommended USB flash memory devices are 256 MB or higher, and formatted with the FAT file system. Some digital audio players may be compatible as well.

Some USB flash memory devices (such as devices with security lockout features, etc.) will not work in this audio unit.

NOTE:

- Do not use a device such as a card reader or hard drive as it or your files may be damaged.

- Do not connect your USB flash memory device using a hub.
- Do not use an extension cable to the USB adapter cable equipped with your vehicle.
- Do not keep a USB flash memory device in the vehicle. Direct sunlight and high heat will damage it.
- We recommend backing up your data before playing a USB flash memory device.
- Some devices cannot be powered or charged via the USB adapter, if this is the case use the accessory adapter to supply power to your device.
- Depending on the type and number of files, it may take some time before they begin to play.

Playing a USB Flash Memory Device (Models with navigation system)

- Depending on the software the files were made with, it may not be possible to play some files, or display some text data.
- Depending on the type of encoding and writing software used, there may be cases where character information does not display properly.
- The order of files in USB playback may be different from the order of files displayed in PC or other devices etc. Files are played in the order stored in USB flash memory device.

Voice Control System

You can select the AUX mode by using the voice control buttons, but cannot operate the play mode functions.

Even if recorded in MP3, WMA or AAC format, a file with unsupported version cannot be played. If the system finds it, the audio unit displays UNSUPPORTED, and then skips to the next file.

NOTICE

Combining a low sampling frequency with a low bitrate may result in extremely degraded sound quality.

Connecting a USB Flash Memory Device

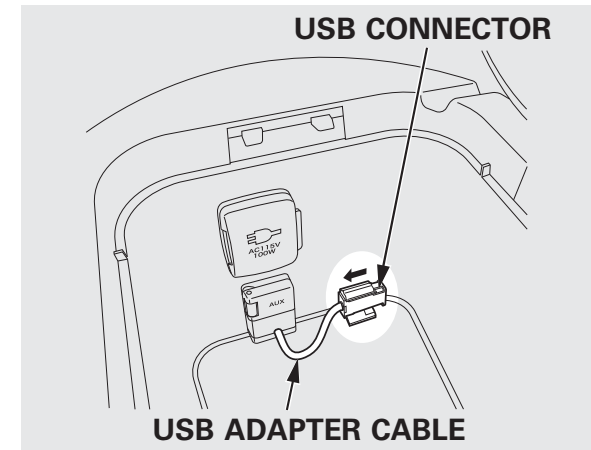

1. Unclip the USB connector by pulling it up, and pull out the USB adapter cable in the console compartment.

CONTINUED

Playing a USB Flash Memory Device (Models with navigation system)

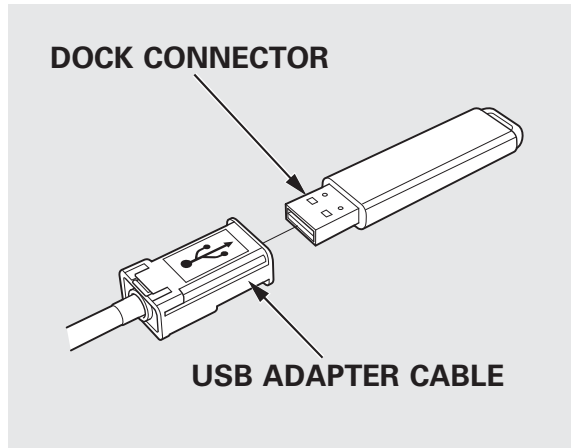

2. Connect the USB flash memory device to the USB adapter cable correctly and securely.

When the USB device is connected and the USB mode is selected on the audio system, the USB indicator is shown in the audio display. It also shows the folder and file numbers. Pressing the AUDIO button displays the USB indicator, the folder and file names, and the elapsed time in the navigation screen.

To Change or Select Files

Use the SKIP button while a USB flash memory device is playing to select passages and change files.

SKIP – Each time you press and release the ►►| side of the SKIP button, the system skips forward to the beginning of the next file. Press and release the |◀◀ side of the button, to skip backward to the beginning of the current file. Press it twice to skip to the beginning of the previous file.

To move rapidly within a file, press and hold either side (►►| or |◀◀) of the SKIP button.

Folder Selection – To select a different folder, turn the TUNE knob to move to the beginning of the next folder. Turn the knob to the right until it clicks once to skip to the next folder, and to the left to move to the beginning of the current folder. Turn it again to skip to the beginning of the previous folder.

Playing a USB Flash Memory Device (Models with navigation system)

To Select a File from Folder and File Lists

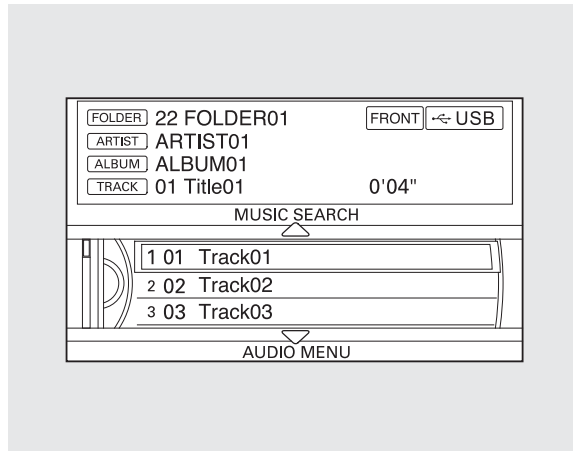

You can also select a folder or file from the list by using the interface dial. Press the AUDIO button to show the audio display on the navigation screen. Use the interface dial to highlight the file, then press ENTER to set your selection.

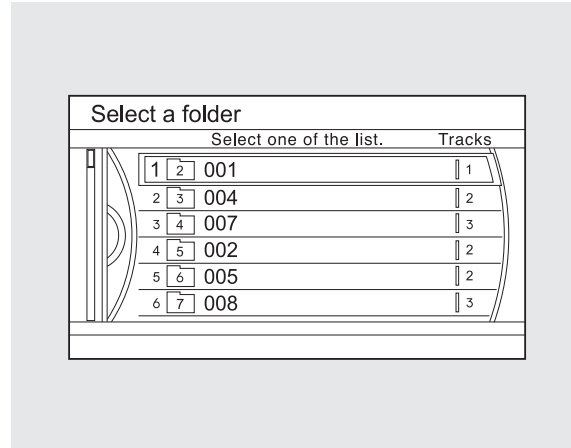

Push the selector up to display the folder list screen, then turn the interface dial to select a folder. Press ENTER to set your selection.

If you have more than one layer of folders (folders within folders), you can also see each folder on the screen.

To go back to the normal playing display, press the AUDIO button. Pressing the CANCEL button goes back to the previous screen and pressing the MAP/GUIDE button cancels the audio mode display.

To Select Repeat, Random or Scan Mode:

Push the interface selector down to display the AUDIO MENU.

You can select any type of repeat, random or scan mode on the audio menu screen.

Move the interface selector up to select BACK to show the USB screen, or press the CANCEL button to return to the previous screen.

CONTINUED

Playing a USB Flash Memory Device (Models with navigation system)

TRACK REPEAT

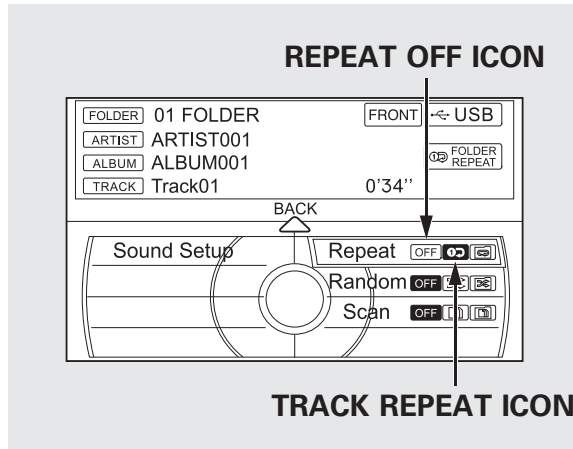

This function repeats playback of the track.

1. On the USB main screen, push the interface selector down to display AUDIO MENU.
2. Turn the interface dial to select Repeat and press ENTER on the interface selector.

3. Turn the interface dial, select the Track Repeat icon and press ENTER on the interface selector. Playback of the track that is currently being played will be repeated.

You can also select the function by using the RPT button.

To cancel this function, turn the interface dial and select the Repeat OFF icon, and then press ENTER on the interface selector.

Pressing either side of the SKIP button also cancels this function.

FOLDER REPEAT

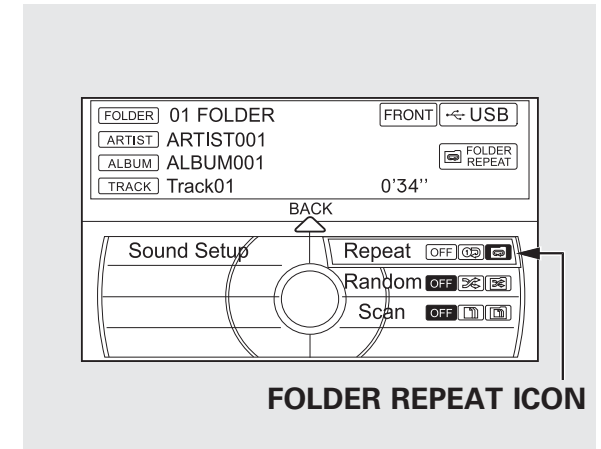

This function replays all the tracks in a folder in the order that they were stored.

1. On the USB main screen, push the interface selector down to display AUDIO MENU.
2. Turn the interface dial to select Repeat and press ENTER on the interface selector.

Playing a USB Flash Memory Device (Models with navigation system)

3. Turn the interface dial, select the Folder Repeat icon and press ENTER on the interface selector. Playback of the folder that is currently being played will be repeated.

You can also select the function by using the RPT button.

To cancel this function, turn the interface dial and select the Repeat OFF icon, and then press ENTER on the interface selector.

TRACK RANDOM

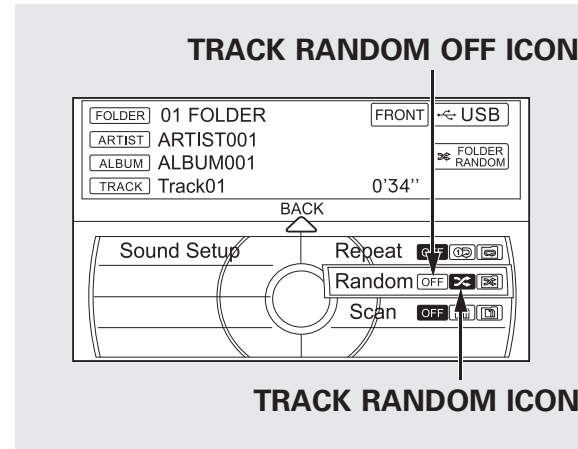

This function plays all the tracks on the USB flash memory device in random order.

1. On the USB main screen, push the interface selector down to display AUDIO MENU.
2. Turn the interface dial, select Random and press ENTER on the interface selector.

3. Turn the interface dial, select the Track Random icon and press ENTER on the interface selector. The tracks are played in random order.

You can also select the function by using the RDM button.

To cancel this function, turn the interface dial and select the Random OFF icon, and then press ENTER on the interface selector.

CONTINUED

Playing a USB Flash Memory Device (Models with navigation system)

FOLDER RANDOM

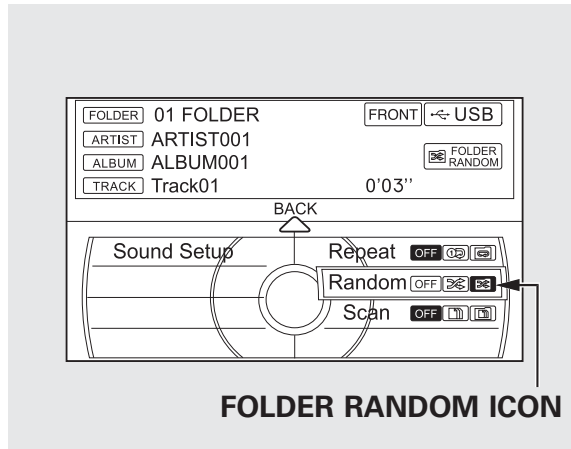

This function plays all of the tracks in the current folder in random order.

1. On the USB main screen, push the interface selector down to display AUDIO MENU.
2. Turn the interface dial, select Random and press ENTER on the interface selector.

3. Turn the interface dial, select the Folder Random icon and press ENTER on the interface selector. The files are played in random order.

You can also select the function by using the RDM button.

To cancel this function, turn the interface dial and select the Random OFF icon, and then press ENTER on the interface selector.

TRACK SCAN

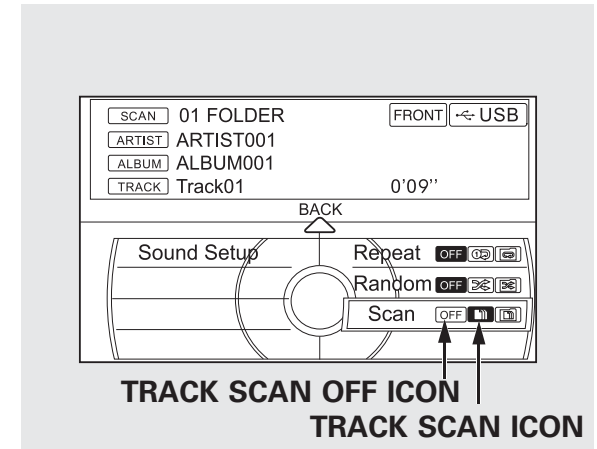

This function samples all the tracks in the current folder in the order that they were recorded.

1. On the USB main screen, push the interface selector down to display AUDIO MENU.
2. Turn the interface dial, select the Scan icon and press ENTER on the interface selector.

Playing a USB Flash Memory Device (Models with navigation system)

3. Turn the interface dial, select the Track Scan icon and press ENTER on the interface selector. Each track or file is sampled for 10 seconds. When all the tracks in the folder have been scanned, regular playback is resumed.

You can also select the function by using the SCAN button.

To cancel this function, turn the interface dial and select the Scan OFF icon, and then press ENTER on the interface selector to play the last track sampled.

FOLDER SCAN

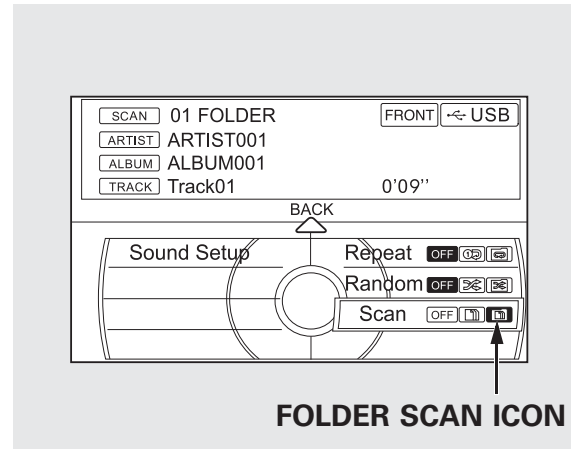

This function samples the first file in each folder within the USB flash memory device.

1. On the USB main screen, push the interface selector down to display AUDIO MENU.
2. Turn the interface dial, select the Scan icon and press ENTER on the interface selector.

3. Turn the interface dial, select the Folder Scan icon and press ENTER on the interface selector.

The first file of the first folder is sampled for 10 seconds. If no other operations are carried out, the first files of the remaining folders are played for 10 seconds. After the first file of the last folder is played back, regular playback is resumed.

To cancel this function, turn the interface dial and select the Scan OFF icon, and then press ENTER on the interface selector.

CONTINUED

Playing a USB Flash Memory Device (Models with navigation system)

To Stop Playing a USB Flash Memory Device

To play the radio, press the AM/FM, or XM button. Press the DISC button to switch to the disc mode. Press the HDD button to switch to HDD Audio.

If you reconnect the same USB flash memory device, the system will begin playing where it left off.

Disconnecting a USB Flash Memory Device

You can disconnect the USB flash memory device at any time even if the USB mode is selected on the audio system. Always follow the USB flash memory device's instructions when you remove it.

When you disconnect the USB flash memory device while it is playing, the audio display and the navigation screen (if selected) show NO DATA.

USB Flash Memory Device Error Messages (Models with navigation system)

If you see an error message in the center display while playing a USB flash memory device, find the solution in the chart to the right. If you cannot clear the error message, take your vehicle to your dealer.

Error Message	Solution
BAD USB DEVICE PLEASE CHECK OWNER'S MANUAL	USB flash memory device is drawing too much current. Check owner's manual for compatible USB devices.
ERROR	Internal USB ROM Error. Try a different USB device.

Bluetooth® Audio System (Models with navigation system)

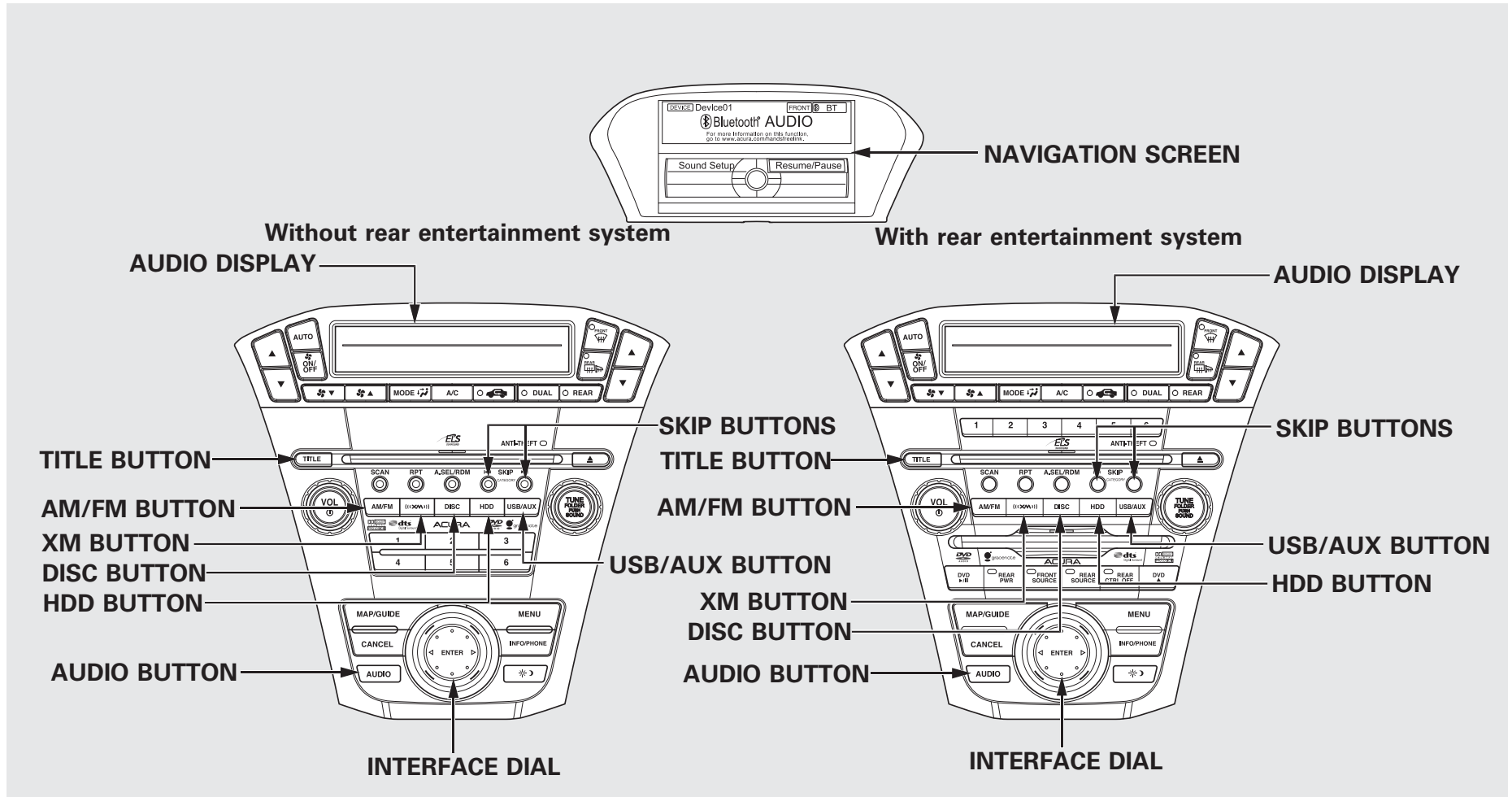

Bluetooth® Audio System (Models with navigation system)

Your vehicle is equipped with a *Bluetooth*® audio system, which allows you to listen to streaming audio from your *Bluetooth*® audio compatible phone. This function is only available on *Bluetooth*® Audio Compatible phones that are paired and linked to the vehicle's *Bluetooth*® HandsFreeLink® (HFL) system (see page 390).

Not all Bluetooth-enabled phones with streaming audio capabilities are compatible with the system. You can find an approved phone by visiting www.acura.com/handsfreelink, or by calling the HandsFreeLink® consumer support at 1-888-528-7876. In Canada, visit www.acura.ca, or call 1-888-9-ACURA-9.

NOTE: In some states, provinces, and territories it may be illegal to perform some data device functions while driving.

To Play *Bluetooth*® Audio Files

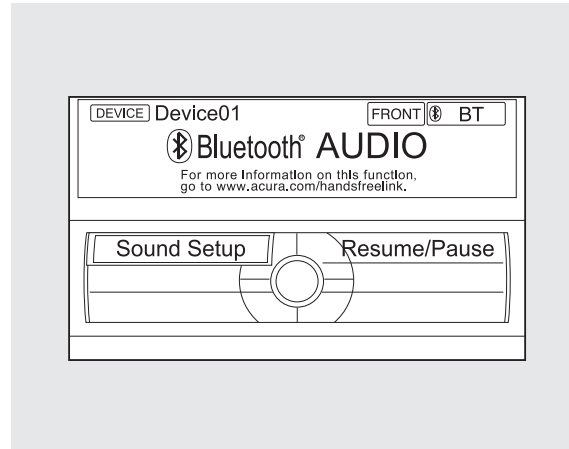

Make sure that your phone is paired and linked to the HFL.

To begin to play the audio files, you may need to operate your phone. If so, follow the phone maker's operating instructions.

Press the USB/AUX button* with the ignition switch in the ACCESSORY (I) or the ON (II) position. When the phone is recognized, you will see the *Bluetooth*® Audio message and icon on the audio display and the audio control display on the navigation screen (if selected), and the system begins to play.

* : If an iPod or USB flash memory device or audio unit connected to the auxiliary input jack was selected at the last mode, you will see iPod, USB or AUX in the audio display and the audio control display on the navigation screen (if selected). Push the USB button again to play audio files from your *Bluetooth*® Audio phone.

CONTINUED

***Bluetooth*[®] Audio System (Models with navigation system)**

Once a device is linked, the name of the device will appear on the screen. Pressing the TITLE button switches the audio display between the *Bluetooth*[®] Audio and the device name.

If more than one phone is paired to the HFL system, there will be delay before the system begins to play.

In the following conditions, the display shows “NO CONNECT” message after pressing the TITLE button.

- The phone is not linked to HFL.
- The phone is not turned on.
- The phone is not in the vehicle.
- Another HFL compatible phone, which is not compatible for *Bluetooth*[®] Audio, is already connected.

If your *Bluetooth*[®] Audio compatible phone does not operate as described, make sure it is an Acura approved phone. To find out if your phone is approved, go to www.acura.com/handsfreelink (in Canada, www.acura.ca), or call the HandsFreeLink[®] consumer support at 1-888-528-7876.

Voice Control System

You can select the AUX mode by using the voice control buttons, but cannot operate the play mode functions.

To skip a file

Press the side ►►| of the SKIP button to skip forward to the next file, and press the |◄◄ side to skip backward to the beginning of the current file. Push the |◄◄ side again to skip to the previous file.

Bluetooth® Audio System (Models with navigation system)

To pause or resume a file

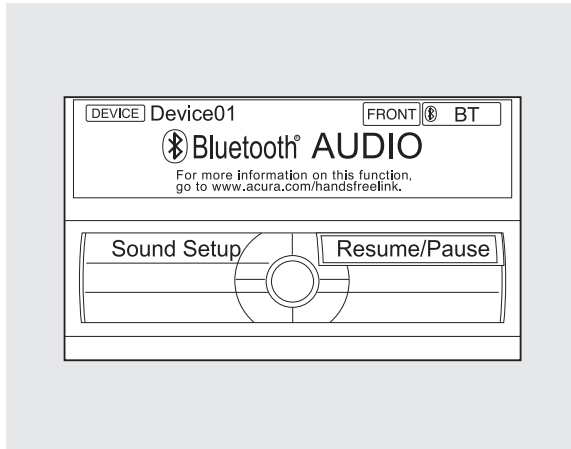

The resume/pause mode can stop playing a file temporarily.

Turn the interface dial to switch the setting between the resume/pause mode and the sound setup mode. Select Resume/Pause, then press ENTER to set your selection. Each time you press ENTER, the system switches between the resume mode and pause mode.

NOTE: The pause function may not be available on some phone devices.

To change sound settings

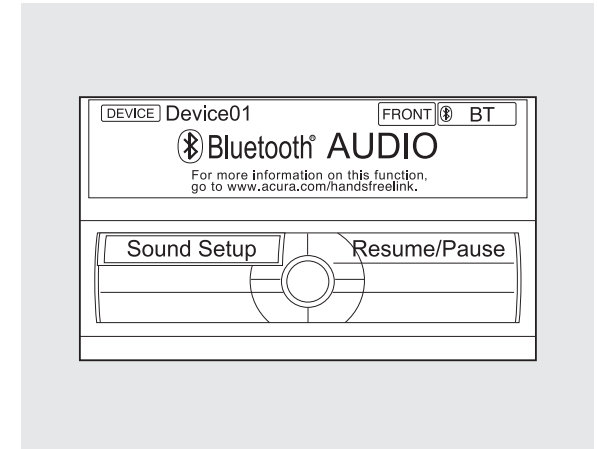

Press the AUDIO button to display the audio control display. Turn the dial to switch the setting between the resume/pause mode and the sound setup mode. Select Sound Setup, then press ENTER to set your selection.

CONTINUED

Bluetooth® Audio System (Models with navigation system)

Turn the dial to select a sound setup mode, then press ENTER to set your selection. See page 222 for more sound setting information.

To switch to HFL mode

If you receive a call when the *Bluetooth®* Audio is playing, press the PICK-UP button on the steering wheel. The screen and the center display switch to the HFL mode (see page 384).

After ending the call, press the HANG-UP button to go back to the *Bluetooth®* Audio mode.

To turn off the Bluetooth® Audio mode

Select any other audio mode by pressing a button; AM/FM, («*XM*») DISC, or HDD on the audio control panel, or press the MODE button on the steering wheel to select another audio mode.

Switching to another mode pauses the music playing from your phone.

As required by the FCC:

This device complies with Part 15 of the FCC rules. Operation is subject to the following two conditions: (1) This device may not cause harmful interference, and (2) this device must accept any interference received, including interference that may cause undesired operation.

Changes or modifications not expressly approved by the party responsible for compliance could void the user's authority to operate the equipment.

This device complies with Industry Canada Standard RSS-210.

Operation is subject to the following two conditions: (1) this device may not cause interference, and (2) this device must accept any interference that may cause undesired operation of the device.

Radio Frequencies

Your vehicle's radio can receive the complete AM and FM bands. Those bands cover these frequencies:

AM band: 530 to 1,710 kHz
FM band: 87.7 to 107.9 MHz

Radio stations on the AM band are assigned frequencies at least 10 kHz apart (530, 540, 550). Stations on the FM band are assigned frequencies at least 0.2 MHz apart (87.9, 88.1, 88.3).

Stations must use these exact frequencies. It is fairly common for stations to round-off the frequency in their advertising, so your radio could display a frequency of 100.9 even though the announcer may identify the station as "FM101."

AM/FM Radio Reception

How well your vehicle's radio receives stations is dependent on many factors, such as the distance from the station's transmitter, nearby large objects, and atmospheric conditions.

A radio station's signal gets weaker as you get farther away from its transmitter. If you are listening to an AM station, you will notice the sound volume becoming weaker, and the station drifting in and out. If you are listening to an FM station, you will see the stereo indicator flickering off and on as the signal weakens. Eventually, the stereo indicator will go off and the sound will fade completely as you get out of range of the station's signal.

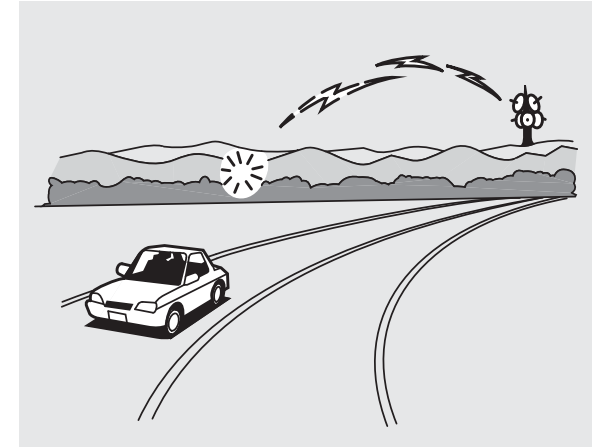

Driving very near the transmitter of a station that is broadcasting on a frequency close to the frequency of the station you are listening to can also affect your radio's reception. You may temporarily hear both stations, or hear only the station you are close to.

CONTINUED

AM/FM Radio Reception

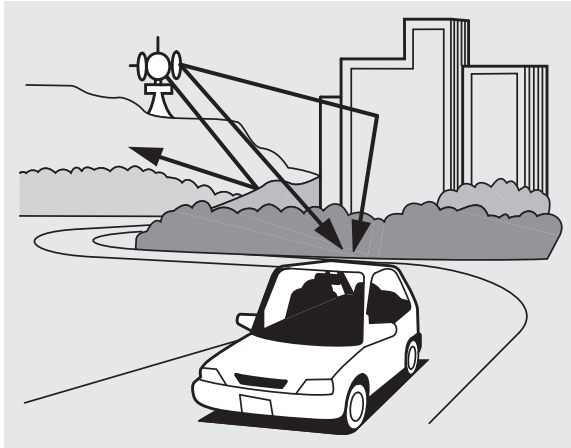

Radio signals, especially on the FM band, are deflected by large objects such as buildings and hills. Your radio then receives both the direct signal from the station's transmitter, and the deflected signal. This causes the sound to distort or flutter. This is a main cause of poor radio reception in city driving.



Radio reception can be affected by atmospheric conditions such as thunderstorms, high humidity, and even sunspots. You may be able to receive a distant radio station one day and not receive it the next day because of a change in conditions.

Electrical interference from passing vehicles and stationary sources can cause temporary reception problems.

*As required by the FCC:
Changes or modifications not expressly
approved by the party responsible for
compliance could void the user's
authority to operate the equipment.*

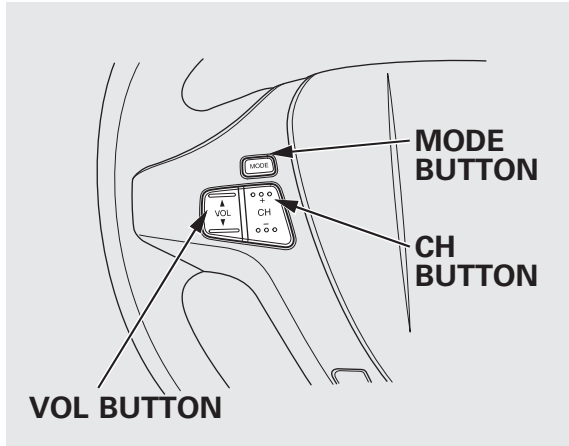

Three controls for the audio system are mounted in the steering wheel hub. These let you control basic functions without removing your hand from the wheel.

The VOL button adjusts the volume up (▲) or down (▼). Press the top or bottom of the button, hold it until the desired volume is reached, then release it.

The MODE button changes the mode. Pressing the button repeatedly selects FM1, FM2, AM, XM radio, disc (if a disc is loaded), HDD (on models with navigation system), *Bluetooth*[®] Audio (if paired), AUX (if an appropriate audio unit is connected).

If an iPod or a USB flash memory device is plugged into the system, you can also select AUX.

If you are listening to the radio, use the CH button to change stations. Each time you press the top (+) of the button, the system goes to the next preset station on the band you are listening to. Press the bottom (-) to go back to the previous preset station. If you press and hold the CH button (+) or (-), the system goes into the skip (seek) mode. It stops when it finds a station with a strong signal.

To activate the seek function, press and hold the top (+) or bottom (-) of the CH button until you hear a beep. The system searches up or down from the current frequency to find a station with a strong signal.

If you are playing a disc, the system skips to the beginning of the next track/file (file in MP3, WMA, or AAC format) each time you press the top (+) of the CH button. Press the bottom (-) to return to the beginning of the current track/file. Press it twice to return to the previous track/file.

CONTINUED

Remote Audio Controls

You will see the track/file number and the elapsed time. If the disc has text data or is compressed in MP3 or WMA, you can also see any other information (track title, file name, folder name, etc.).

In MP3 or WMA mode, you can use the seek function to select folders. Press and hold the top (+) of the CH button until you hear a beep, to skip forward to the first file of the next folder. Press the bottom (-) to skip backward to the previous folder.

If you are playing a USB flash memory device or iPod with the USB adapter cable, press and release the top (+) of the CH button to skip forward to the beginning of the next file. Press the bottom (-) to skip backward to the beginning to the current file. Press it twice to return to the previous file.

When playing a USB flash memory device, you can also use the seek function to skip the folder. To activate this, press and hold either side of the CH button until you hear a beep.

On models without navigation system

If you are playing a conventional CD (without the text data and not compressed in MP3 or WMA), you can use the skip function to select discs. Press and hold the top (+) of the CH button until you hear a beep, to skip forward to the next disc. Press and hold the bottom (-) to skip backward to the previous disc.

Auxiliary Input Jack

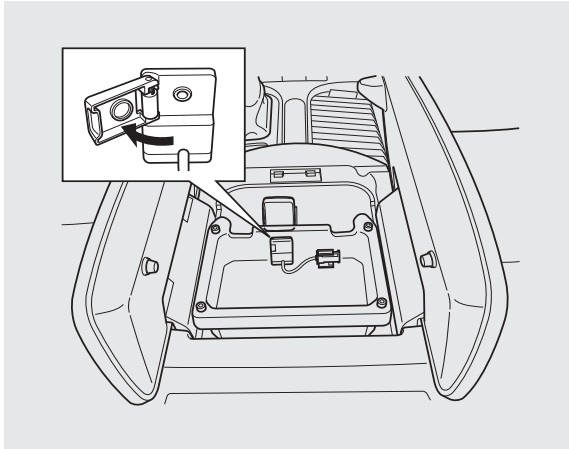

The auxiliary input jack is inside the console compartment. The system will accept auxiliary input from standard audio accessories using a 1/8 inch (3.5 mm) stereo miniplug.

When a compatible audio unit is connected to the jack, press the USB/AUX button (DISC/AUX button on models without navigation system) to select it.

On models with Rear Entertainment System

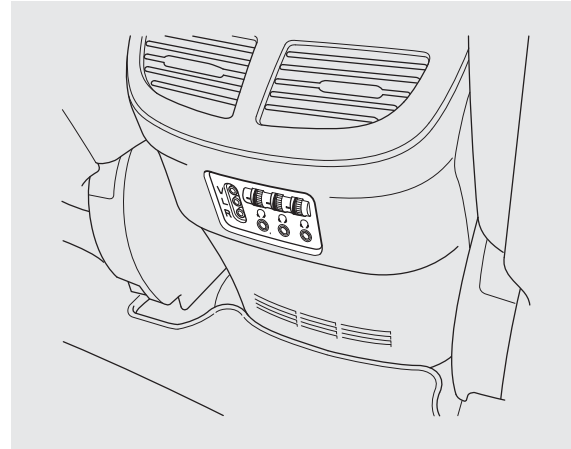

Auxiliary input jacks and headphone connectors for the rear entertainment system are on the back of the center console compartment.

For more information, see page 339.

Radio Theft Protection

If your vehicle's battery is disconnected or goes dead, the audio system disables itself. If this happens, you will see "ENTER CODE" in the frequency display next time you turn on the system. Use the preset buttons (Icons on models with navigation system) to enter the five-digit code. The code is on the Anti-theft Identification Card included in your owner's manual kit. When it is entered correctly, the radio will start playing.

The Anti-theft Identification Card also lists your audio serial number. It is best to store the card in a safe place at home. In addition, you should write the audio system's serial number in this owner's manual.

If you make a mistake entering the code, do not start over; complete the five-digit sequence, then enter the correct code. You have ten tries to enter the correct code. If you are unsuccessful in ten attempts, you must then leave the system on for one hour before trying again.

The system will retain your AM and FM presets even if power is disconnected.

NOTE:

If you have a My Acura account, it is easy to retrieve the anti-theft code online without having to access the serial number.

U.S. owners

We recommend that you register the security code at My Acura (myacura.com.) If you lose the Anti-theft Identification Card before registering the code at My Acura, you must obtain the code from your dealer or <https://radionavicode.acura.com/>. To do this, you will need the audio system's serial number. If you do not have the serial number with you, ask your dealer or go to <https://radionavicode.acura.com/> for information on how to retrieve it.

Canadian owners

If you lose the Anti-theft Identification Card, you must obtain the code from your dealer. To do this, you will need the audio system's serial number. If you do not have the serial number with you, ask your dealer how to retrieve it.

Models with navigation system

You need to enter the same code for the navigation system to reactivate. Read the navigation system manual for details.

Setting the Clock and Calendar

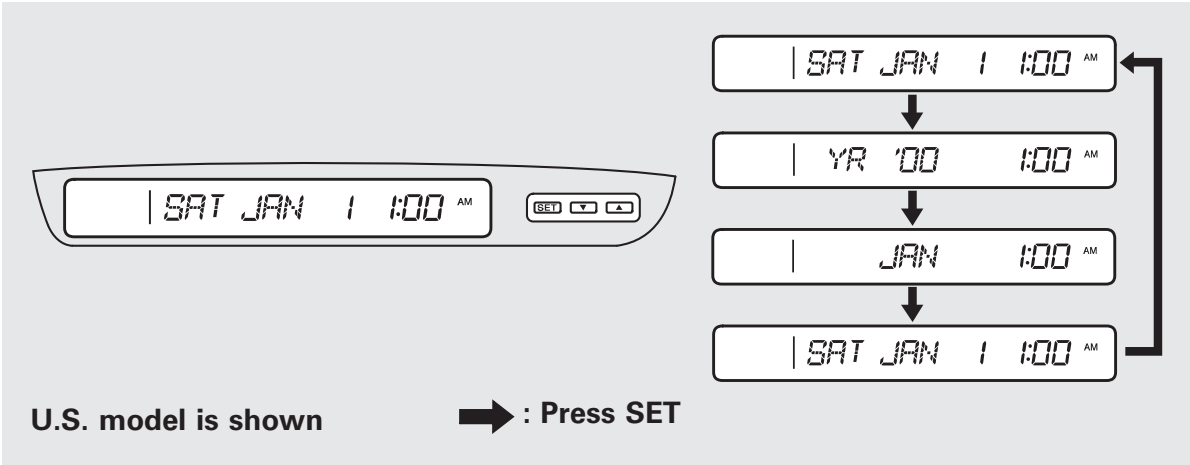

On models without navigation system
You can see the clock and calendar information on the upper display.

To set the clock and the calendar:

1. Press and hold the SET button until the clock display begins to blink.

- 2. Press and release the SET button repeatedly. The mode switches from hours, minutes, AM/PM, year, month, then to day as shown above.
- 3. Select the desired mode by pressing the SET button, then press either ▼ or ▲ button to change the setting.

4. After you set the day information, pressing the SET button again will cancel this setting mode and the system shows the adjusted display.

The system will also automatically return to the normal display about 10 seconds after you stop adjusting a mode.

On models with navigation system
The navigation system receives signals from the global positioning system (GPS), and the displayed time is updated automatically by the GPS. Refer to the navigation system manual for how to adjust the time.

Features

Rear Entertainment System

U.S. Technology Package with Entertainment, Advance Package with Entertainment, Canadian Technology, and Elite Packages

Your vehicle is equipped with a rear entertainment system that includes a DVD player for the enjoyment of the rear passengers.

With this system, the rear passengers can enjoy a different entertainment source (radio, disc, HDD, USB, iPod®, DVD player, or XM Radio) than the front seat occupants. The audio is broadcast through the supplied wireless headphones.

The ignition switch must be in the ACCESSORY (I) or the ON (II) position to operate the rear entertainment system.

NOTICE

This vehicle's overhead mounted video display, if so equipped, includes mercury-containing components. Upon removal, please reuse, recycle, or dispose of as hazardous waste.

To Turn On the System

Press the REAR PWR button. The overhead screen will open to the position it was last set. The indicator on the REAR PWR button will come on, as well as the indicator on the FRONT SOURCE button. The rear seat passengers can then operate the rear system from the control panel in the ceiling. The rear control panel can also be detached and used as a remote control, by pushing the RELEASE button, and pulling the remote toward you.

Pressing the REAR CTRL OFF button disables rear control. The indicator in the button comes on and your passengers can no longer operate the system with the rear control panel. When the button is pressed, the “CTRL OFF” message appears in the overhead screen to let your passengers know that the control panel is disabled.

The rear system selects the source it was last set to. If that source has been removed (the DVD has been ejected from the player, for example), you will see “No Disc” in the display. You should select another source or insert a DVD.

Rear Speakers

When you turn on the system, the rear speakers are automatically turned off if the rear system selects a different entertainment source than the front system. You will see the Rear Speakers Off icon both in the audio display and the overhead screen. The sound for the rear system is sent to the wireless headphones.

If you want to turn the rear speakers on again, press and hold the REAR PWR button until the Rear Speakers Off icon goes off.

NOTE: The rear speakers are connected to the front system, so they will always play the source that the front system is set to.

CONTINUED

Rear Entertainment System

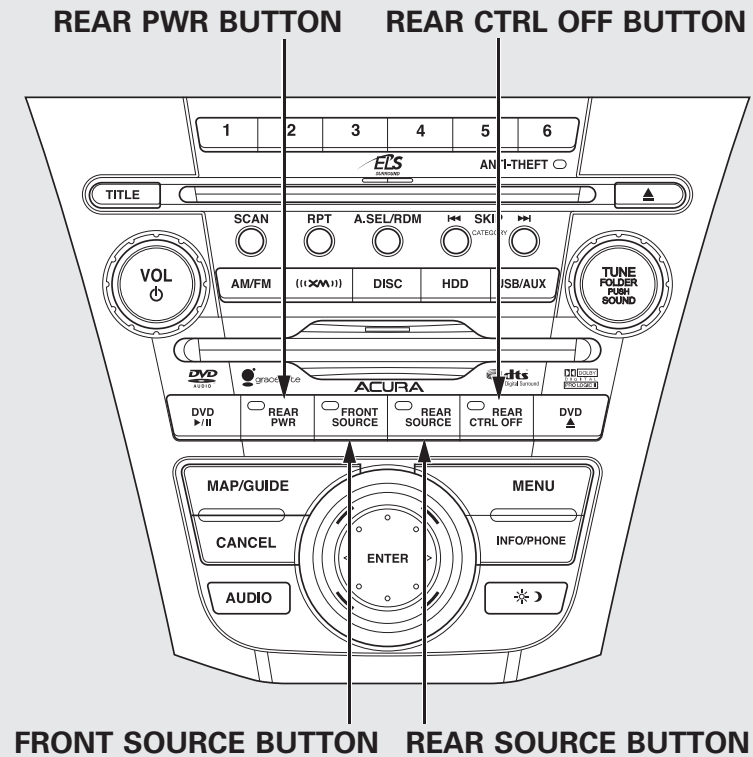

OVERHEAD SCREEN UNIT

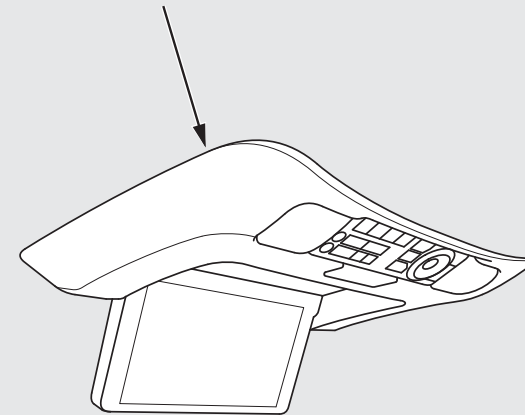

To Select Rear Entertainment from the Front Control Panel

To operate the rear entertainment system from the front panel, press the REAR SOURCE button. You will hear two beeps and the indicator in the button comes on to show that the control panel is enabled.

If you do not operate the rear entertainment system from the front panel within 10 seconds, the indicator goes off and the FRONT SOURCE indicator comes on automatically.

Radio controls for the front entertainment system can also be used to operate the rear entertainment system.

Operating the DVD Player from the Front Control Panel

The DVD player in your rear entertainment system can play DVD video discs, audio CDs, MP3/WMA discs, and DTS CDs.

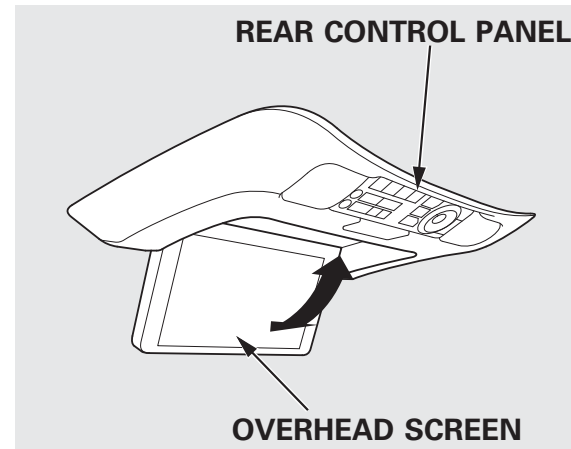

Press the REAR PWR button in the front panel or press the  button in the rear control panel when REAR PWR is on. The overhead screen will open to the position it was last set.

You can tilt the screen at nine different angles from 90 to 130 degrees using the tilt button in the rear control panel. The default setting is 100 degrees.

To continuously adjust the angle of the overhead screen, press and hold the TILT button.

CONTINUED

Rear Entertainment System

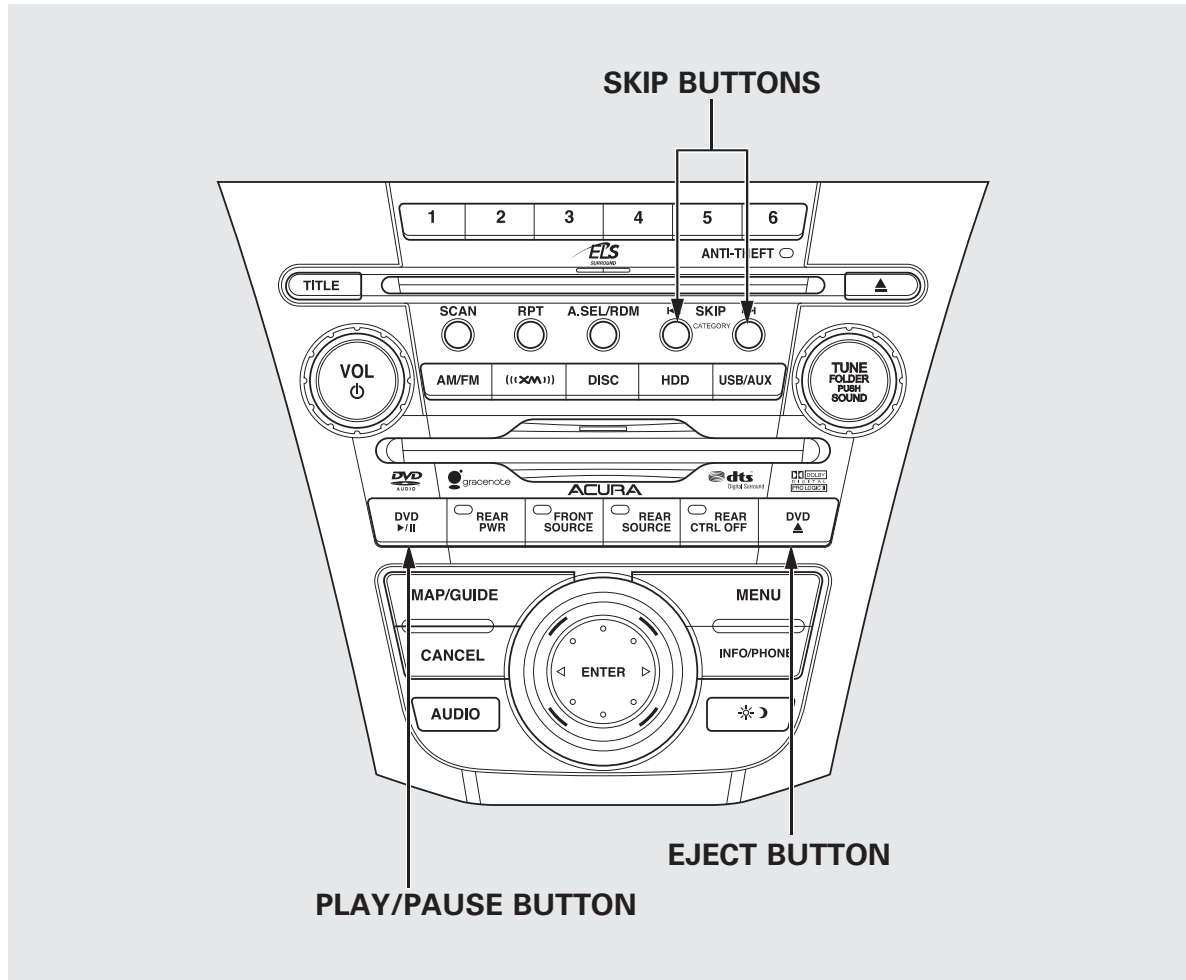

Insert a DVD into the lower DVD/CD slot in the audio unit.

Push the DVD in halfway, the drive will pull it in the rest of the way.

PLAY – Press the DVD (▶ II) button if the DVD does not start playing automatically.

PAUSE – Press the DVD (▶ II) button to pause the DVD. Press the button again or press PLAY to resume. Pause works only with the DVD player.

SKIP – Press and hold the ►► button to move forward; you will see the time elapsed shown in the overhead screen advancing rapidly. Press and hold the ◀◀ button to move backward; you will see the time elapsed shown in the overhead screen decreasing. Release the button when the system reaches the point you want.

Each time you press the ►► button and release it, the system skips forward to the beginning of the next track or chapter. Press and release the ◀◀ button to skip backward to the beginning of the current track. Press and release it again to skip to the beginning of the previous track or chapter.

EJECT – Press the eject button to remove the DVD from the drive.

To Return to Front Audio Controls

To return front panel control to the front audio system, press the FRONT SOURCE button. You will hear a beep and the indicator in the button comes on. The indicator also comes on automatically, when you do not operate the rear entertainment system within 10 seconds.

Using the Rear Control Panel

To turn on the rear entertainment system from the rear control panel, press the PWR button. Use the DVD/AUX button, DISC/HDD button, XM RADIO button, or FM/AM button to select the entertainment source. The selected source will be shown in the display. Make sure the rear control operation has not been disabled with the REAR CTRL button on the front panel. When the audio system is off or the front side rear power is off, the rear control panel cannot be turned on.

CONTINUED

Rear Entertainment System

To Play the Radio from the Rear Control Panel

Press the FM/AM button to listen to the radio.

Press the MENU button to display the Audio Menu on the overhead screen. You can enter the highlighted function by pressing the ENTER button. These functions have the same features as those of the front audio system. You can press and hold either side (◀◀ or ▶▶) of the TUNE/SKIP bar to skip (seek) up/down, and press either side (◀◀ or ▶▶) of the TUNE/SKIP bar to tune up/down.

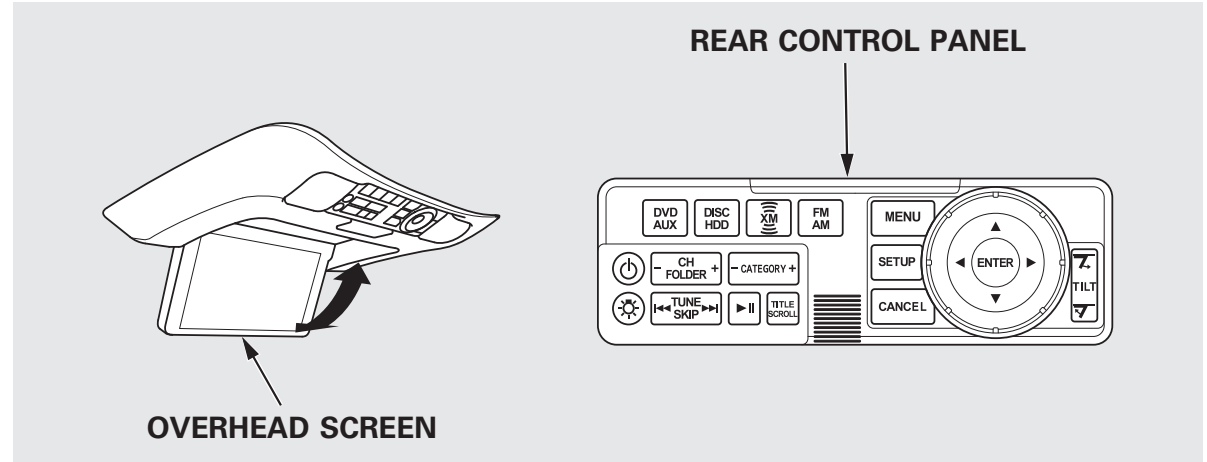

To Play the XM Radio from the Rear Control Panel

Press the XM button to listen to the XM radio. You can press either side (◀◀ or ▶▶) of the TUNE/SKIP bar to scroll up/down and select channels within a category (in CATEGORY mode), or to scroll up/down and select from among all available channels (in CH mode).

Press the MENU button to display the Audio Menu on the overhead screen. You can enter the highlighted function by pressing the ENTER button. These functions have the same features as those of the front audio system.

Pressing and holding the TITLE/SCROLL button for 5 seconds enables you to switch between search modes.

To Play a Disc, HDD, USB, or iPod® from the Rear Control Panel

Press the MENU button to display the Audio Menu on the overhead screen. Use the interface dial to highlight REPEAT, RANDOM, or SCAN on the screen. You can enter the highlighted function by pressing the ENTER button. These functions have the same features as those of the front audio system.

When TITLE/SCROLL button is pressed, the title scrolls. When it's pushed again, scrolling stops.

To Play a DVD from the Rear Control Panel

The video screen is for use by rear seat passengers only. The driver and front seat passenger should not try to view the screen while driving.





Press the REAR PWR button in the front panel or press the  button in the rear control panel when REAR PWR is on. The overhead screen will open to the position it was last set.

You can tilt the screen at nine different angles from 90 to 130 degrees using the tilt button in the rear control panel. The default setting is 100 degrees.

Press the  button when you want to pause the DVD. Press this button again to go back to PLAY.

Press the  button to skip to the beginning of the next chapter. Press the  button to return to the beginning of the current chapter.

Press the  button again quickly to go to the previous chapter.

To move rapidly within a chapter, press and hold the  or  button. The system will continue to move through the chapter. Press the  button to move forward, or the  button to move backward. Release the button when the system reaches the point you want.

To select the menu on the DVD, press the MENU button. Use the interface dial to turn to the desired menu selection, then press the ENTER button to enter your selection.

CONTINUED

Rear Entertainment System

TITLE/SCROLL Button

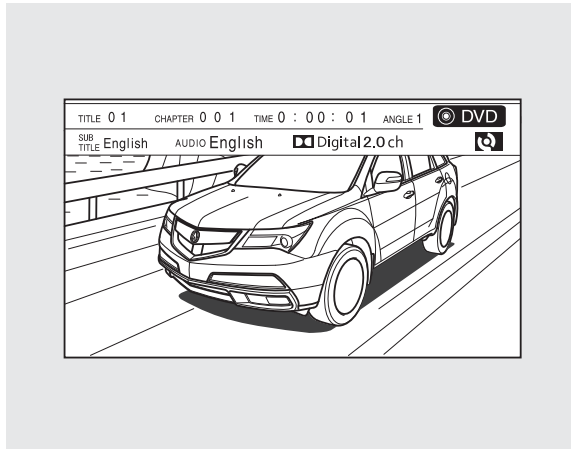

When you press the TITLE/SCROLL button while a DVD is playing, the current status of title, chapter, elapsed time, angle, subtitle, audio, and sound characteristics, with the personal surround logo are displayed. To return to the DVD video screen, press the TITLE/SCROLL button again.

If you do not press the TITLE/SCROLL button, the screen returns to the DVD video screen after several seconds.

MENU Button

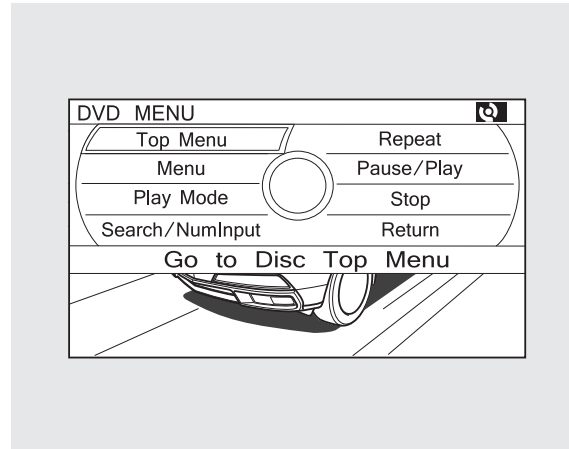

When you press the MENU button while a DVD is playing, the DVD Menu appears. The menu options are TOP MENU, MENU, PLAY MODE, SEARCH/NUMINPUT, REPEAT, PAUSE/PLAY, and STOP.

To go to your selected menu, use the interface dial to highlight the icon and press the ENTER button. To return to the DVD video screen, select RETURN.

Top Menu

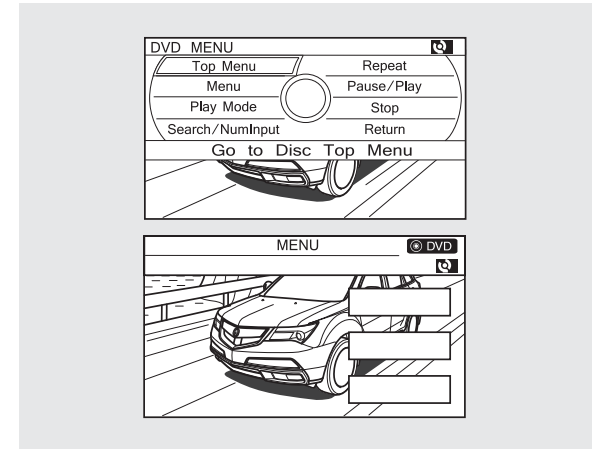

When you select "TOP MENU", the screen changes to the DVD's title menu. This menu also appears when you press the MENU button while a DVD is not playing. To go back to play, press the MENU or CANCEL button.

Menu

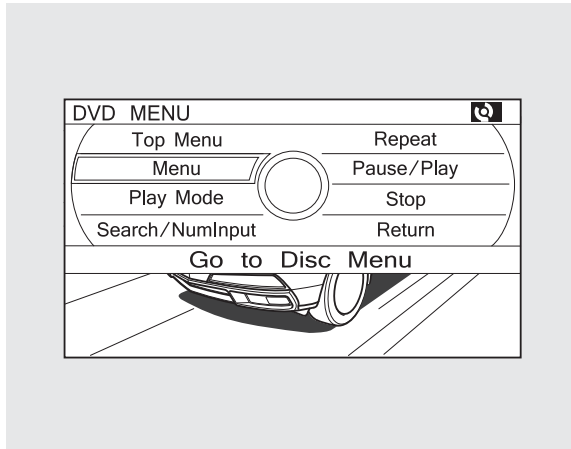

When you select “MENU” with the interface dial, the screen changes to the DVD's title menu.

Play Mode

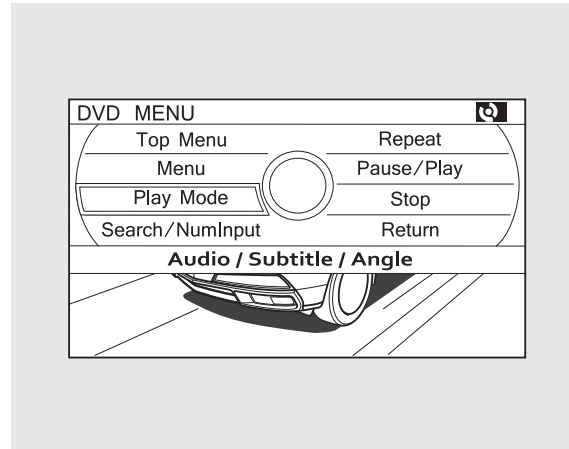

When you select “PLAY MODE” with the interface dial, you can change the DVD's Audio, Subtitle or Angle setting.

“Audio”

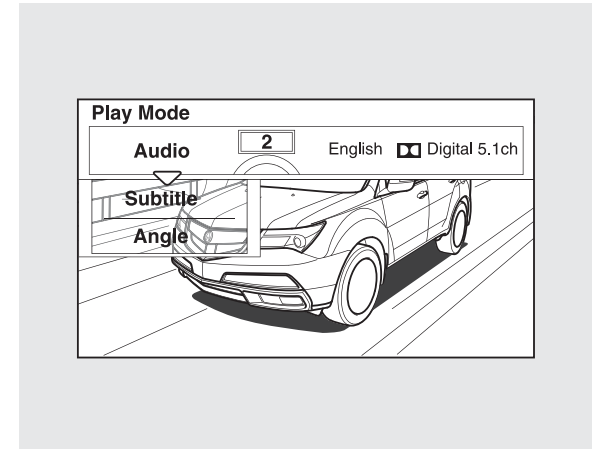

To change the Audio setting, highlight “Audio” from the play mode menu with the ▼ or ▲ button. A submenu of the dubbed language appears. You can select another language by turning the interface dial. The sound characteristics (Dolby Digital, LPCM, MPEG Audio, dts) recorded with the selected language is also displayed next to the language.

CONTINUED

Rear Entertainment System

The selectable languages vary from DVD to DVD, and this feature may not be available on some DVDs.

To go back to play, press the MENU or CANCEL button.

“Subtitle”

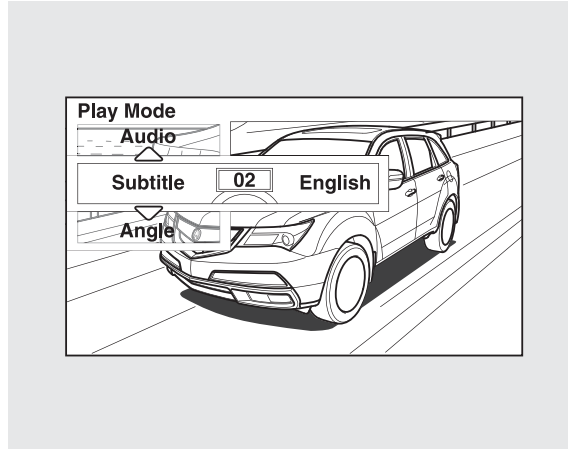

To change the DVD's subtitle, highlight “Subtitle” from the play mode menu with the ▼ or ▲ button. You can see the available subtitles with the interface dial.

To go back to play, press the MENU or CANCEL button.

“Angle”

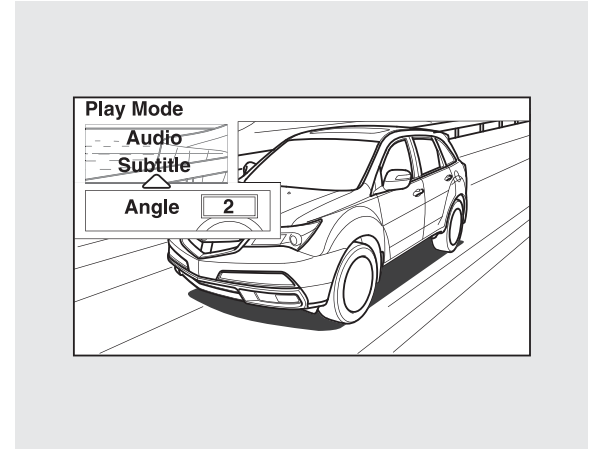

To change the view angle, highlight “Angle” from the play mode menu with the ▼ or ▲ button. You can see the available angle options with the interface dial.

If there are no multiple angles available on the DVD, you cannot change from “Angle 1”.

To go back to play, press the MENU or CANCEL button.

Search

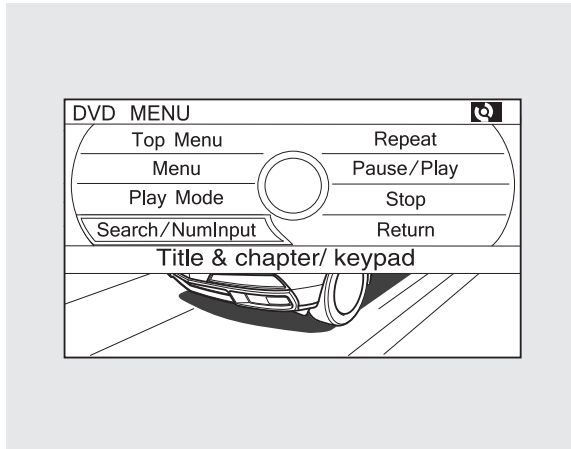

Highlight "SEARCH" with the interface dial to select "Title", "Chapter", or "NumInput" and press ENTER.

"Title/Chapter Search"

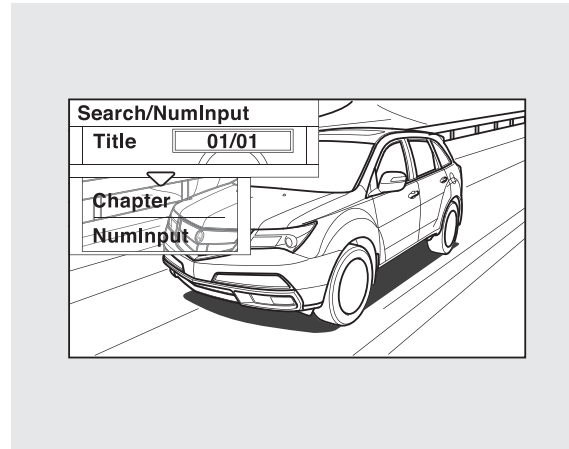

With "Title" highlighted, use the interface dial to jump to your desired title and press the ENTER button. When "Chapter" is highlighted, follow the same procedure for the chapter search.

NumInput

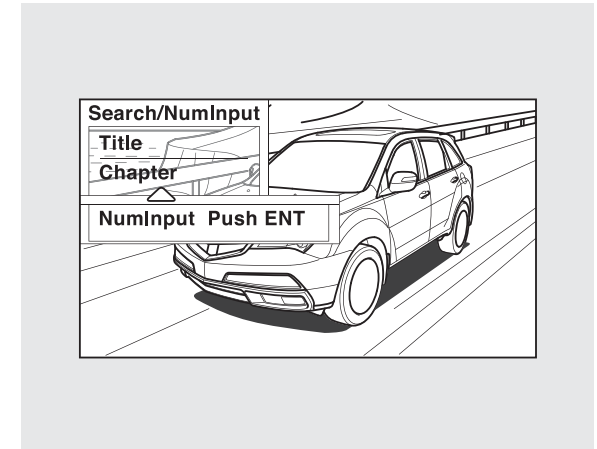

A numerical command can be issued to a DVD by inputting a three digit number, and a button number can be selected on the screen.

Highlight "NumInput" with the interface dial. Press the ENTER button to go to the NumInput selection screen.

CONTINUED

Rear Entertainment System

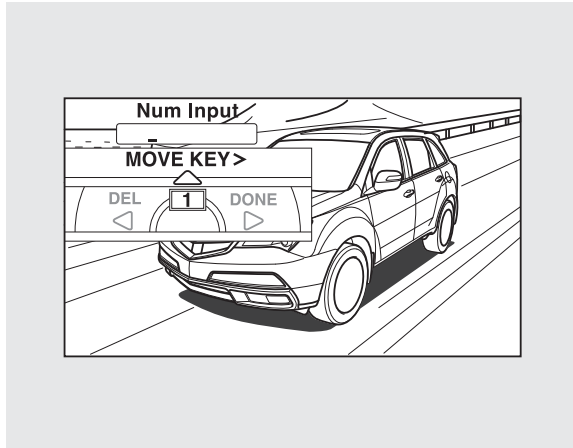

Rotate the interface dial to select each number, then press the ENTER button. Press the ► button when you have finished inputting the number. If you want to delete a number, press the ◀ button, and if you want to change the input order of a number, press the ▲ button.

To go back to the DVD screen, press the MENU or CANCEL button or select RETURN and press the ENTER button.

Repeat

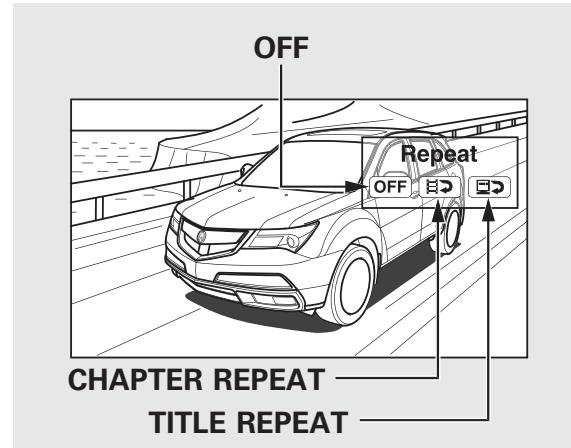

When you select “REPEAT” with the interface dial, the screen changes to the repeat mode menu.

SETUP Button

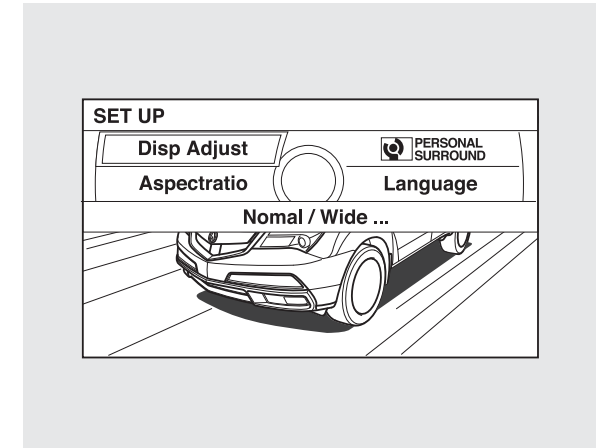

When you press the SETUP button while a DVD is playing, the setup menu appears. The menu options are “Disp Adjust”, “Aspect Ratio”, “Personal Surround”, and “Language”.

To change a setup, use the interface dial to highlight your selection and press the ENTER button. To return to the DVD video screen, press the SETUP or CANCEL button.

Disp Adjust

To adjust the display, highlight “Disp Adjust” from the setup menu with the interface dial and press the ENTER button. You can adjust these display settings:

- Brightness
- Contrast
- Black Level
- Color
- Tint

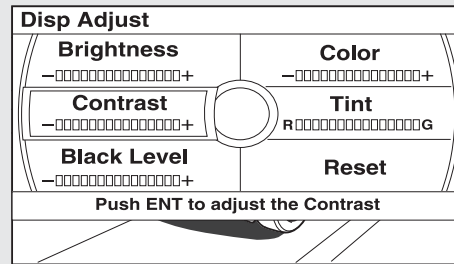

Select the quality you want to adjust by turning the interface dial. Adjust the setting by turning the interface dial. To go back to the Disp Adjust screen, press the ENTER or CANCEL button.

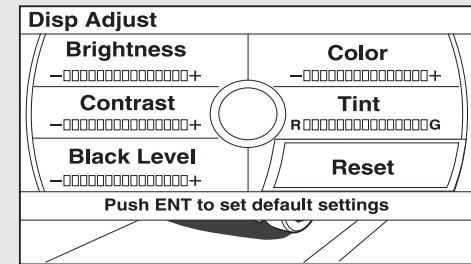

If you want to set the display to the default setting, select “Reset” by turning the interface dial, and, then pressing the ENTER button.

CONTINUED

Rear Entertainment System

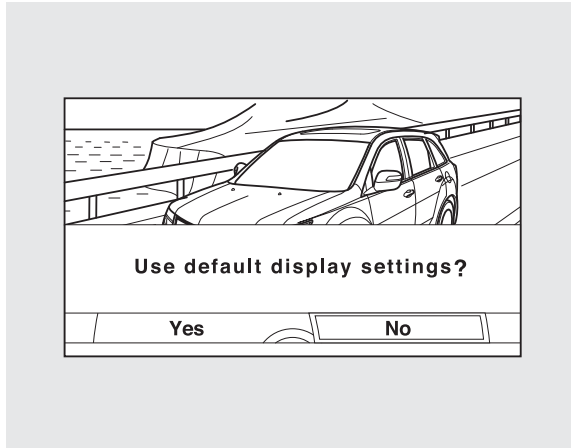

The display changes as shown above.

Select “Yes,” and press the ENTER button. You will see the message “Default display settings applied” on the display for 5 seconds.

Aspect Ratio

You can set the screen mode to these settings:

- Normal
- Wide
- Zoom
- Full

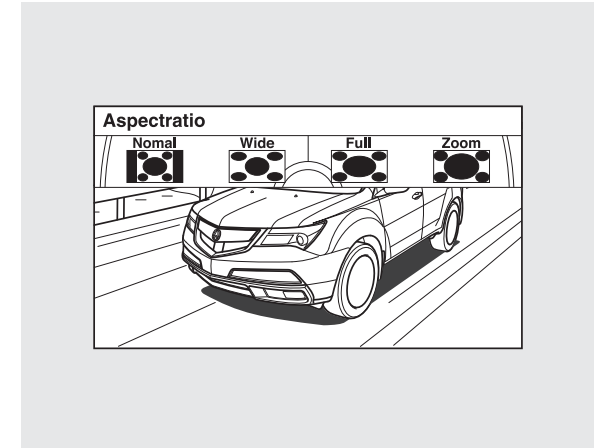

Select the “Aspect Ratio” by turning the interface dial, then press the ENTER button. The selectable setting menu is displayed, and the current setting is highlighted in blue. Select the desired setting by turning the interface dial, then press the ENTER button.

The selected setting will be highlighted in blue for one second, and the screen returns to the play mode in the selected setting.

Personal Surround

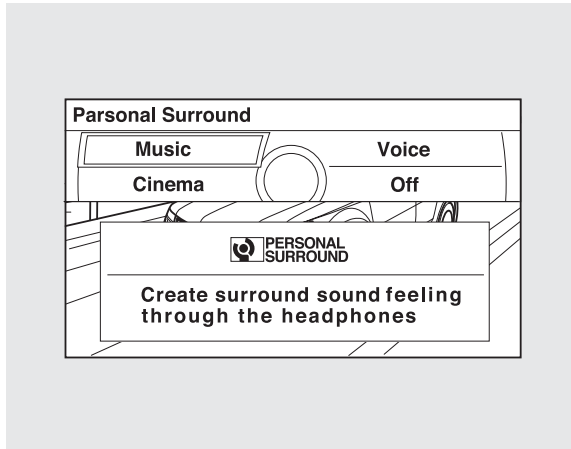

To change the Personal Surround setting, highlight “Personal Surround” from the setup menu with the interface dial and press the ENTER button. The effect selection appears.

Select “Music,” “Cinema,” or “Voice” by turning the interface dial, and enter your selection by pressing the ENTER button. The “PERSONAL SURROUND” logo is displayed in the upper right corner of the screen.

If you select “Off,” the logo disappears, and there will be no special sound effect.

Language

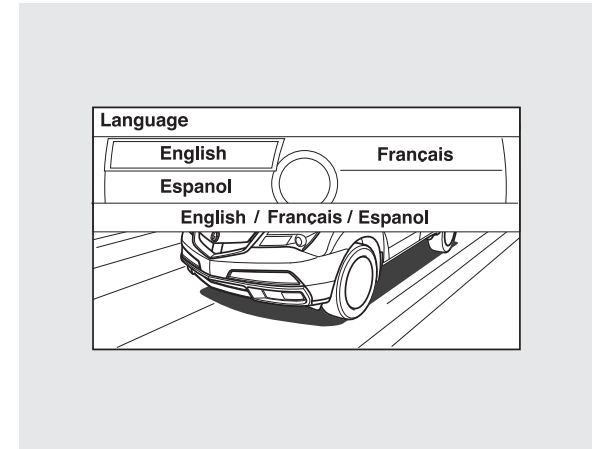

You can change the display language to English, French, or Spanish. Rotate the interface dial to the setting you want, then press the ENTER button.

CONTINUED

Rear Entertainment System

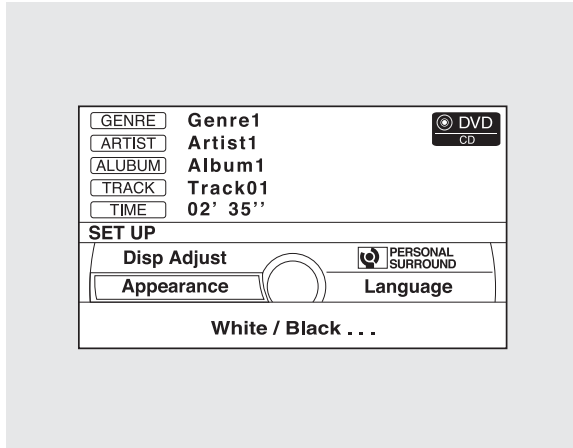

When you press the SETUP button while a DVD is not playing, the setup menu appears for audio.

Disp Adjust, Personal Surround, and Language

The operation for these menus is the same as that for using the DVD player.

Appearance

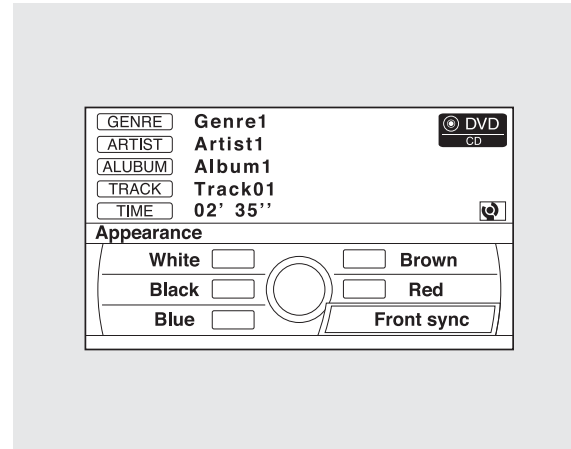

You can change the color of the screen to white, black, blue, brown, or red. You can also synchronize with the front navigation system. Rotate the interface dial to the setting you want, then press the ENTER button.

INITIAL SETTINGS Menu

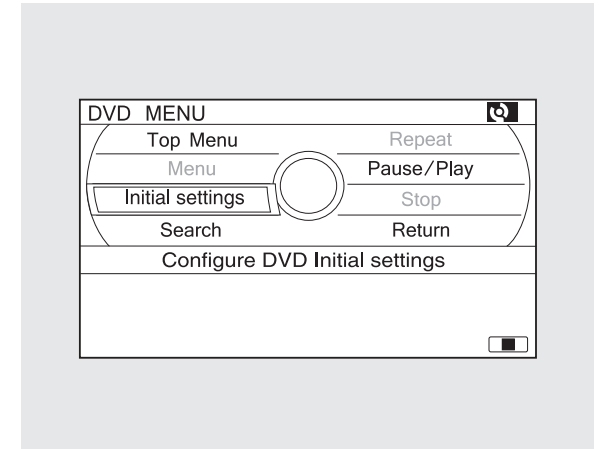

When you press the MENU button on the rear control panel when a DVD is not playing, the “INITIAL SETTINGS” menu is displayed.

There are five selectable menus: “Language” “Dynamic Range”, “Angle Mark”, “Parental Level”, and “Password”.

INITIAL SETTINGS (Language)

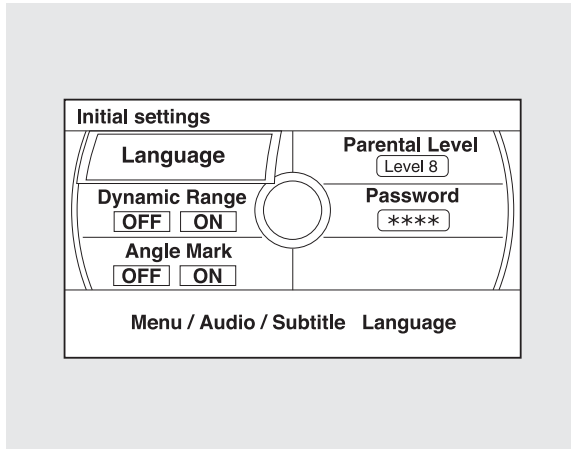

When you select “Language” with the interface dial, the menu shown above appears.

To return to the stop or previous screen, press the CANCEL button.

Because the priority language is determined by each disc you insert, you might not be able to set a selected item.

Menu Language

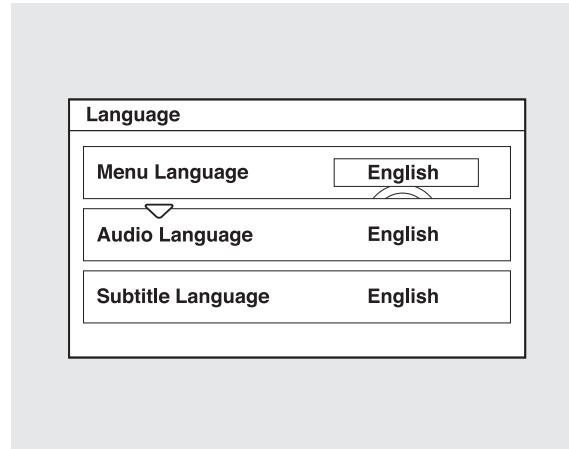

To select the language used in the DISC menus, select “Menu Language” by pressing the ▼ or ▲ button.

Select the desired language by turning the interface dial, and then pressing the ENTER button.

The selectable languages are, English, French, Spanish, German, Italian, Dutch, Chinese, Korean, Thai, Japanese or others.

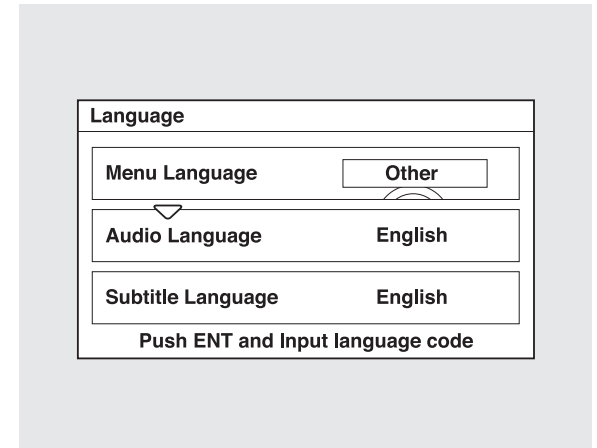

If you want another language than those listed, you need to enter the code number of the desired language. Select “other,” and press the ENTER button. The display changes as shown in the next column.

CONTINUED

Rear Entertainment System

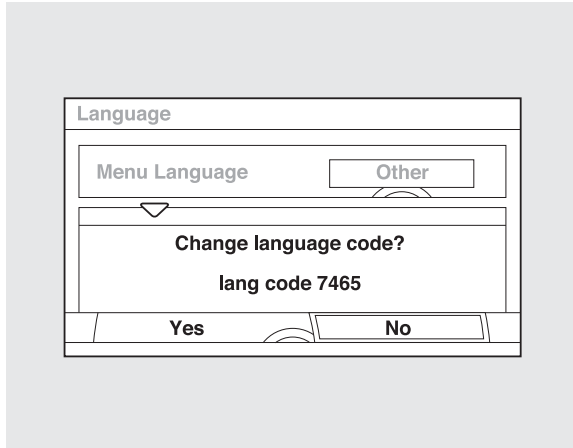

If you select “No,” and press the ENTER button, the display returns to the initial screen of the “Language” menu.

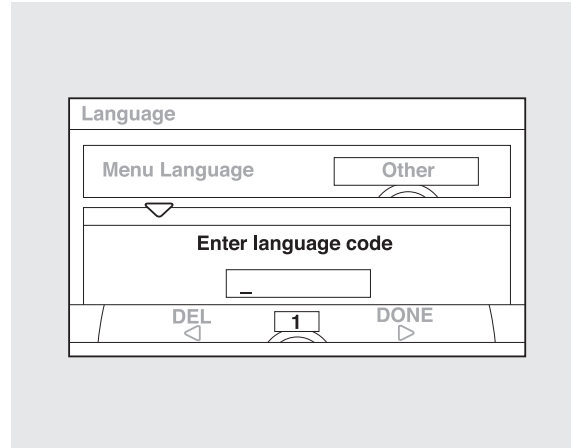

If you select “Yes,” the display changes to the language code input mode. Select the first digit using the interface dial, and press the ENTER button to enter it. Repeat this until all four digits are filled. Press the ► button on the control panel to enter the new language code.

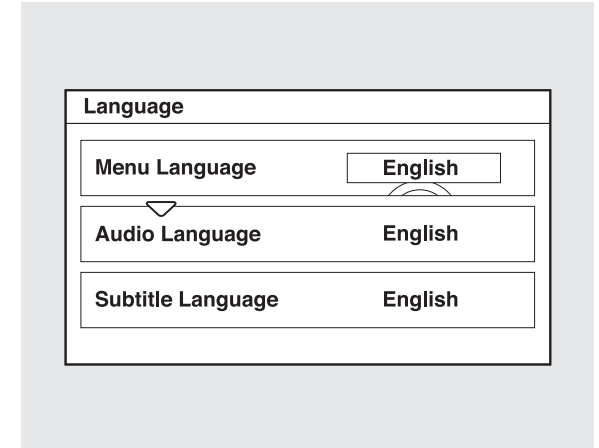

If you made a mistake entering a number digit, press the ◀ button on the control panel. Then select and enter the correct digit as described. The display returns to the initial “Language” menu screen.

Audio Language

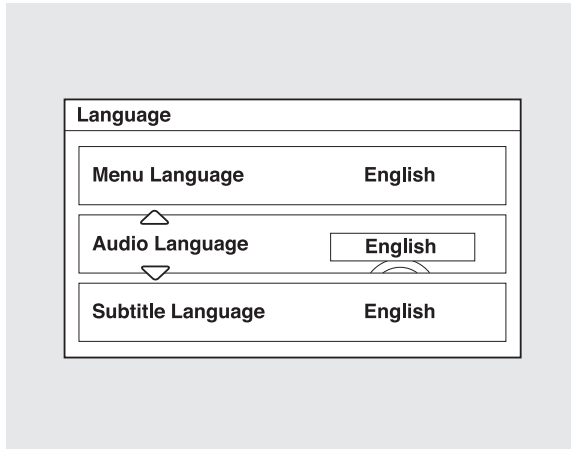

You can select the dubbed language before playing DVDs. Select “Audio Language” by pressing the ▼ or ▲ button.

Follow the same instructions you used to set the menu language.

Subtitle Language

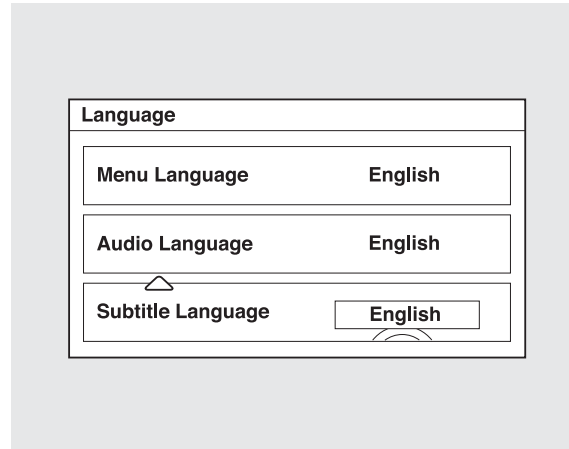

You can select the subtitle language before playing DVDs. Select “Subtitle Language” by pressing the ▼ or ▲ button.

Follow the same instructions you used to set the menu language.

Dynamic Range
“Dynamic Range” reduces the differences between the loud and quiet sound levels throughout the disc. When this is on, the louder sounds are lowered, and quieter sounds are increased.

CONTINUED

Rear Entertainment System

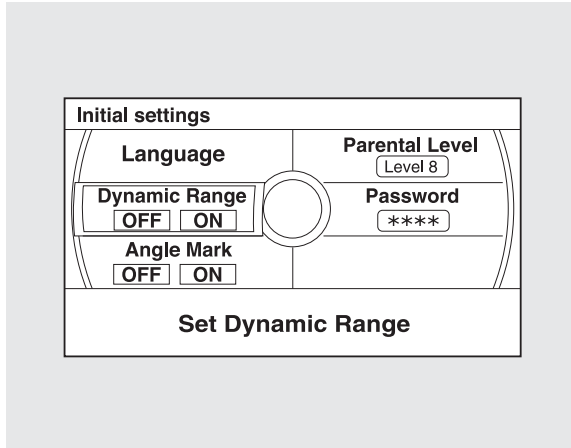

Select the “Dynamic Range” by turning the interface dial.

To turn “Dynamic Range” on or off, select “ON” or “OFF” by turning the interface dial, and then press the ENTER button.

Angle Mark

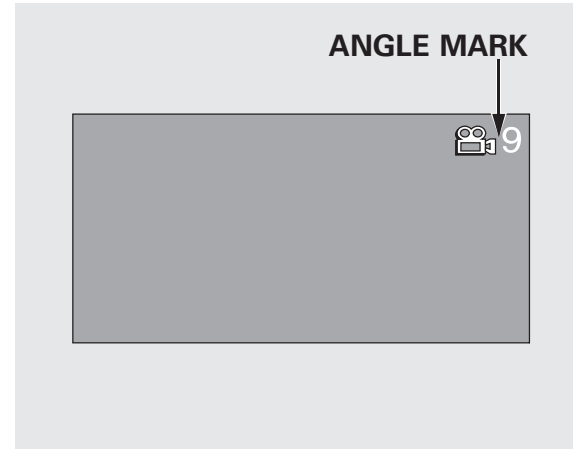

When you switch to another angle while playing a DVD, the angle mark is displayed in the upper right corner of the screen.

You can set the system to display or not display this angle mark.

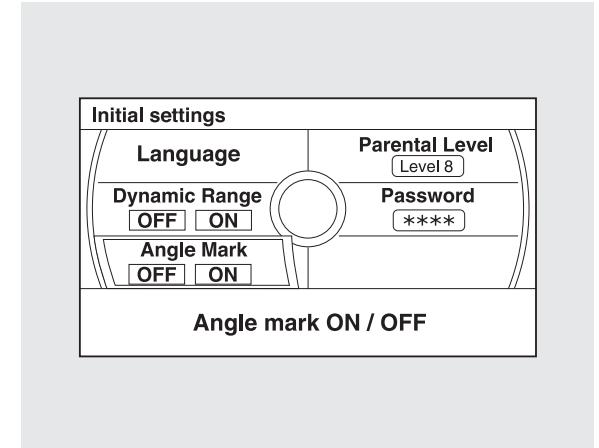

Select the “Angle Mark” by turning the interface dial. If you want the angle mark to be displayed, select “ON” by turning the interface dial, and then press the ENTER button.

Parental Level

You can place an auditory restriction by changing the parental control level. The higher the level number, the lower the restriction.

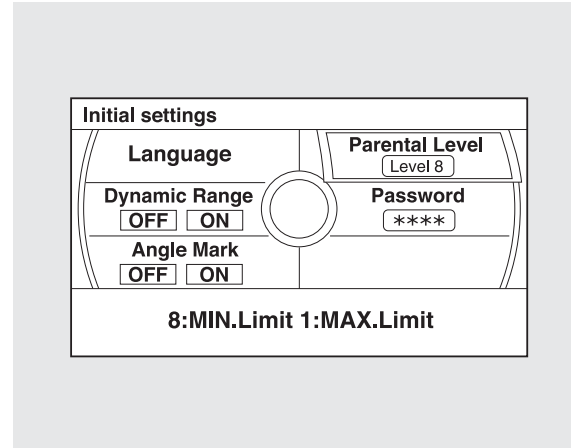

Highlight “Parental Level” and press the ENTER button. You will see the submenu. If you select “No” and press the ENTER button, the screen goes back to the “Others” menu.

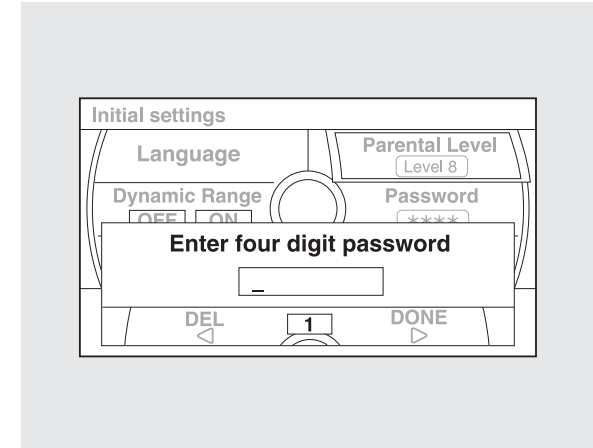

When you select and enter “Yes,” the display changes as shown above. To change the level, you need to enter your four digit password. Select the number for the first digit by turning the interface dial, and enter it by pressing the ENTER button. Repeat this until all four digits are filled. Press the ► button on the control panel.

CONTINUED

Rear Entertainment System

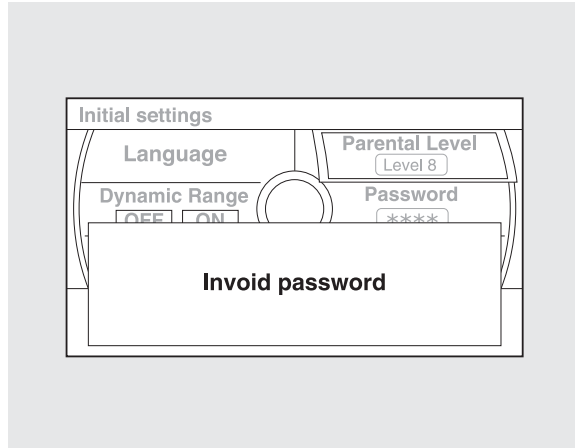

If the system does not recognize the password you entered, you will see the above display. Repeat the parental control level steps until you enter the correct password.

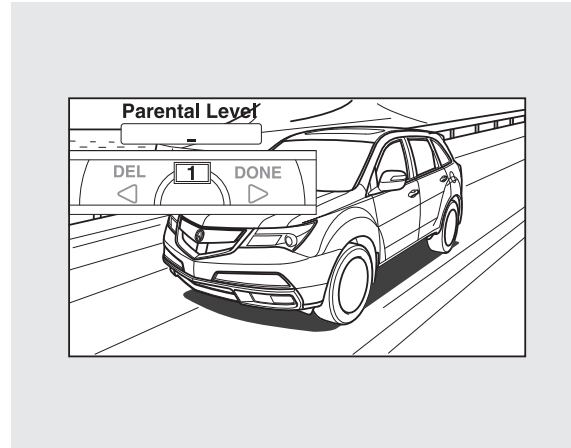

If you enter the password correctly, you can then change the parental control level.

Once you correctly enter the password, turn the interface dial to change the level, and then press the ENTER button. Press the ► button to enter your selection.

Changing the Password

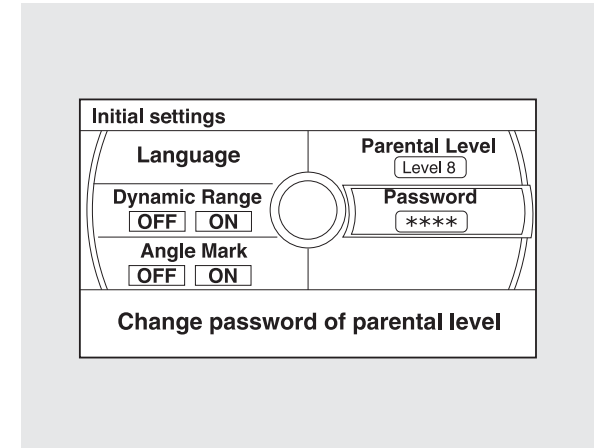

The password was set to "1111" when the vehicle left the factory.

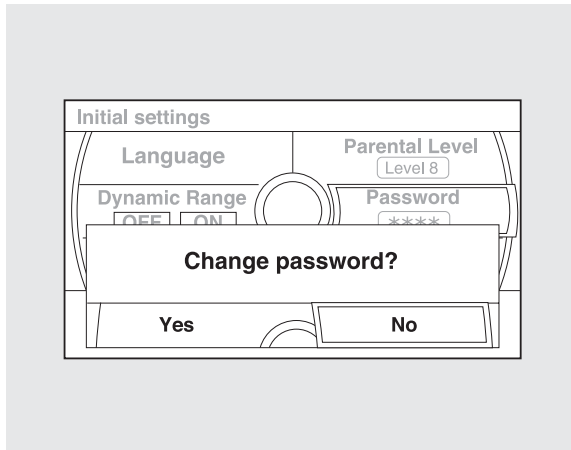

To change the password, select "Password." You will see the above menu displayed. Select "Yes" by turning the interface dial, then press the ENTER button.

If you select "No," and press the ENTER button, the display returns to the "Others" menu.

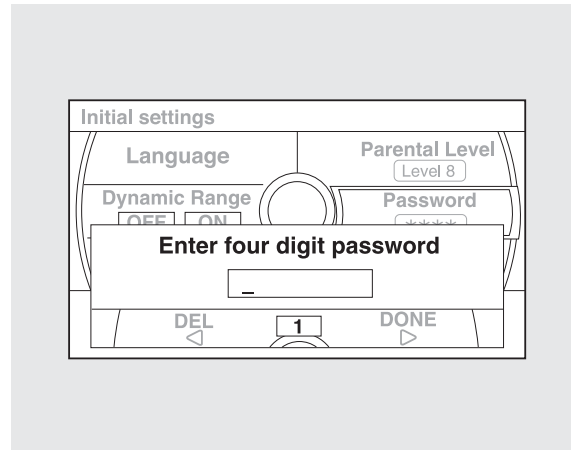

Select the first digit by turning the interface dial, and enter it by pressing the ENTER button. Repeat this until all four digits are entered. Press the ► button on the control panel.

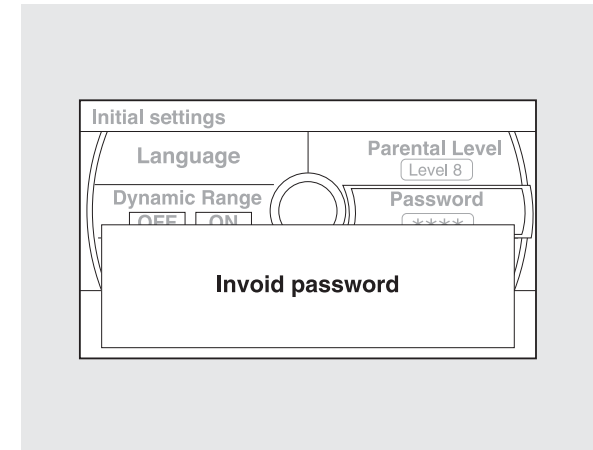

If the system does not recognize the password you entered, you will see the above display. Repeat the password setting steps until you enter the correct password.

CONTINUED

Rear Entertainment System

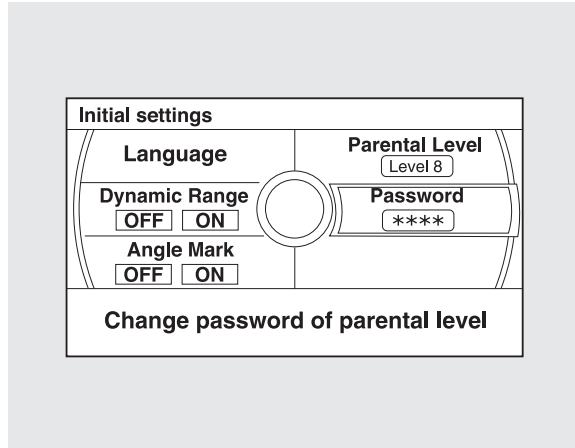

If you forget the password, select "Password," and press the ▲ button 10 times.

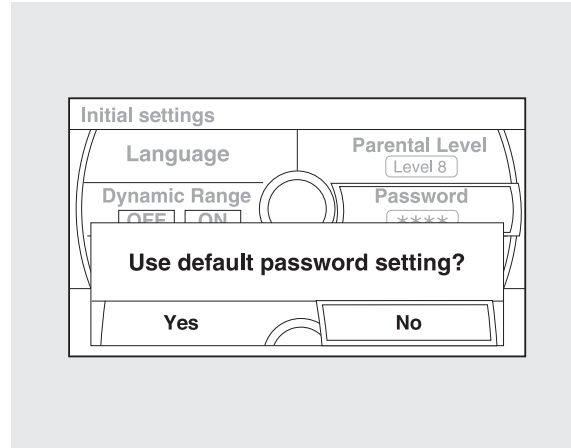

The display changes as shown above. If you want to use the default password (1111), select "Yes," and press the ENTER button.

The message "Default password setting applied" is displayed for 5 seconds.

Remote Control

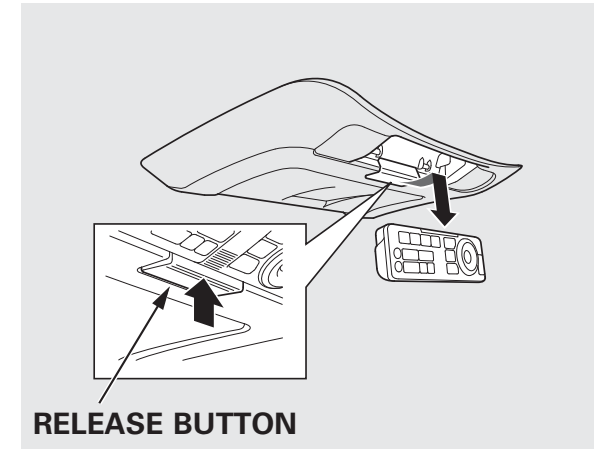

The rear control panel can be detached from the ceiling unit and used as a remote control. To remove it from the ceiling unit, press the release button. The control panel will swing down partway. Pivot it down further past the detent until it detaches from the hinge. To reinstall it, reverse the procedure.

Replacing the Remote Control Batteries

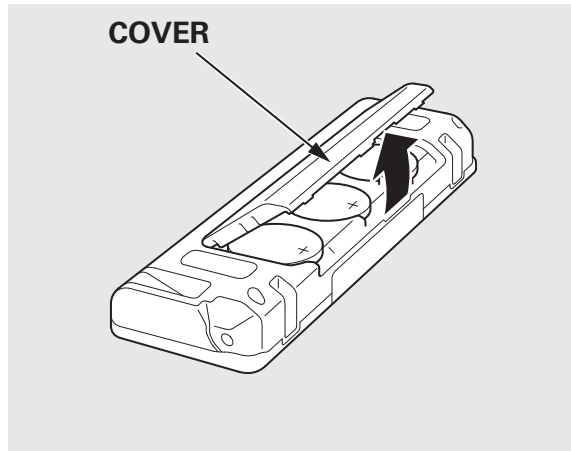

If it takes several pushes on the button to operate the rear entertainment system, have your dealer replace the batteries as soon as possible.

Battery type: BR3032

An improperly disposed of battery can hurt the environment. Always confirm local regulations for battery disposal.

*As required by the FCC:
This device complies with Part 15 of the FCC rules. Operation is subject to the following two conditions: (1) This device may not cause harmful interference, and (2) this device must accept any interference received, including interference that may cause undesired operation.*

Changes or modifications not expressly approved by the party responsible for compliance could void the user's authority to operate the equipment.

This device complies with Industry Canada Standard RSS-210.

Operation is subject to the following two conditions: (1) this device may not cause interference, and (2) this device must accept any interference that may cause undesired operation of the device.

CONTINUED

Rear Entertainment System

Playable DVDs



There are various types of DVDs available. Some of them are not compatible with your system.

The DVD player in your rear entertainment system can play DVDs and CDs bearing the above marks on their packages or jackets.

The DVD player can also play discs recorded in MP3/WMA formats and DTS CDs.

Those packages or jackets should also bear the designation of “1” or “ALL”. DVD-ROMs cannot be played in this system.

This product incorporates copyright protection technology that is protected by U.S. patents and other intellectual property rights.

Use of this copyright protection technology must be authorized by Macrovision, and is intended for home and other limited viewing uses only unless otherwise authorized by Macrovision.

Reverse engineering or disassembly is prohibited.

Protecting DVDs

The tips on how to handle and protect DVDs are basically the same as those for compact discs. Refer to “Protecting Your Discs” on page 247.

DVD Player Error Messages

The chart on the right explains the error messages you may see in the display while playing a disc.

If you see an error message in the display while playing a disc, press the eject button. After ejecting the disc, check it for damage or deformation. If there is no damage, insert the disc again.

The audio system will try to play the disc. If there is still a problem, the error message will reappear. Press the eject button, and pull out the disc.

Insert a different disc. If the new disc plays, there is a problem with the first disc. If the error message cycle repeats and you cannot clear it, take your vehicle to a dealer.

Error Message	Cause	Solution
DISC ERROR	FOCUS Error	Press the disc eject button, and remove the disc. Check for an error indication. Insert the disc again. If the code does not disappear or the disc cannot be removed, consult your dealer.
MECH ERROR	Mechanical Error	Press the disc eject button, and remove the disc. Check for an error indication. Insert the disc again. If the code does not disappear or the disc cannot be removed, consult your dealer.
HEAT ERROR	High Temperature	Will disappear when the temperature returns to normal.
REGION ERR	Invalid region code	The disc is not playable in this unit. Eject the disc, and insert a disc compatible with this system.
PARENT ERR	Invalid parental control level	Reinsert the disc, and increase the parental control level (see page 331).

CONTINUED

Rear Entertainment System

Wireless Headphones



Some state and local government agencies prohibit the use of headphones by the driver of a motor vehicle. Always obey applicable laws and regulations.

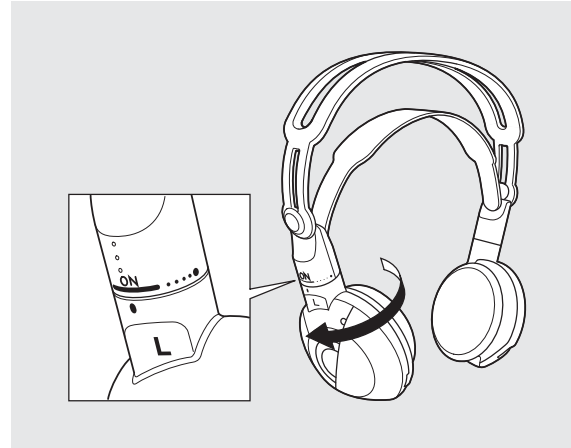

The audio for the rear entertainment system is sent to the wireless headphones that come with the system. When using the headphones, make sure you wear them correctly: L (left) and R (right) are marked on the sides of the frame. Wearing the headphones backwards may affect audio reception, limiting the sound quality and range.

To use the headphones, pivot the earpieces outward. This turns them on. To adjust the volume, turn the dial on the bottom of the right earpiece. When you remove the headphones, the earpieces automatically pivot inward, and the headphones turn off. When not in use, store the headphones in the pocket of either front seat.

Replacing Batteries

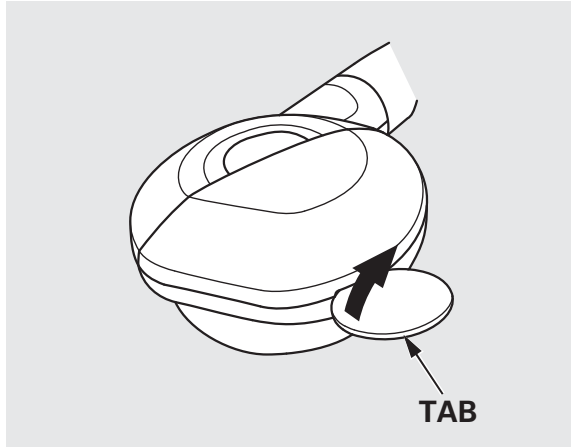

Each headphone uses one AAA battery. The battery is under the cover on the left earpiece. To remove the cover, insert a coin in the slot and twist it slightly to pry the cover away from the earpiece. Pull the cover outward, and pivot it out of the way.

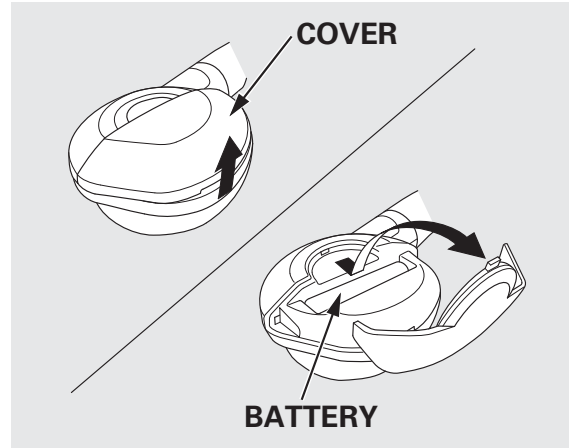

Remove the battery. Install the new battery in the earpiece as shown in the diagram next to the battery slot. Slide the cover back into place on the earpiece, then press down on the back edge to lock it in place.

Auxiliary Input Jacks

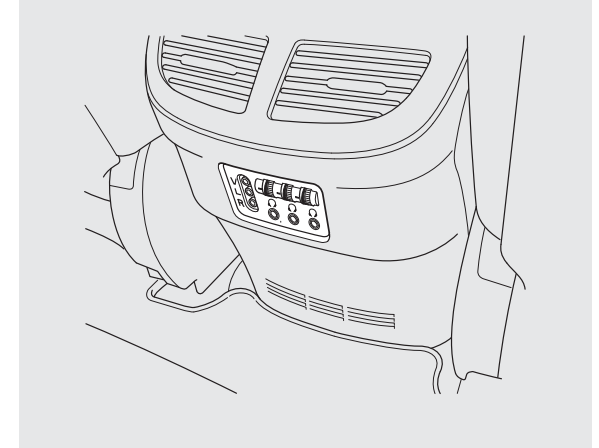

Auxiliary input jacks and headphone connectors for the rear entertainment system are on the back of the center console compartment.

CONTINUED

Rear Entertainment System

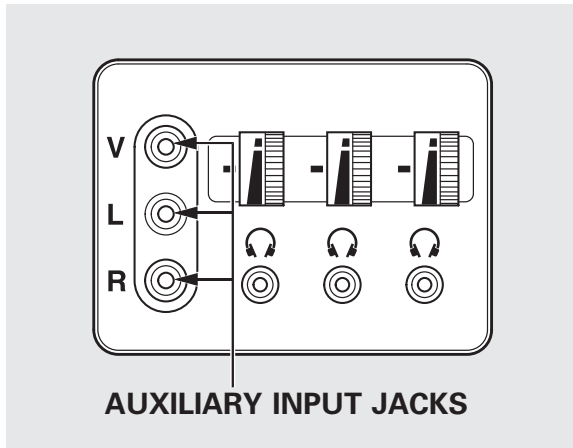

The system will accept auxiliary inputs from standard video games and video equipment. Some video game power supplies may cause poor picture quality.

V = Video jack
L = Left audio jack
R = Right audio jack

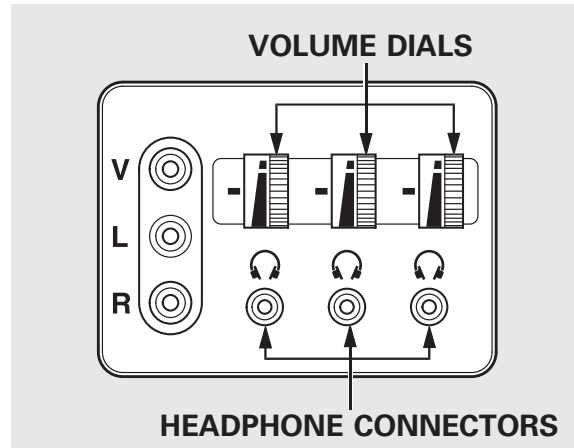

There are three headphone connectors for the third seat passengers. Each connector has its own volume control.

The security system helps to protect your vehicle and valuables from theft. The horn sounds and a combination of headlights, position lights, side marker lights and taillights flashes if someone attempts to break into your vehicle or remove the audio unit. This alarm continues for two minutes, then the system resets. To deactivate the system before the two minutes have elapsed, unlock the driver's door with the key or the remote transmitter.

The security system automatically sets 15 seconds after you lock the doors, hood, and tailgate. For the system to activate, you must lock the doors from the outside with the key, or use driver's lock tab, door lock master switch, or remote transmitter. The security system indicator on the instrument panel starts blinking immediately to show you the system is setting itself.

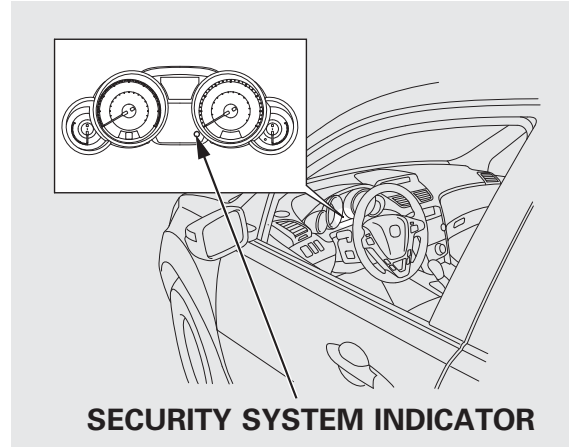

Once the security system sets, opening any door, tailgate, or hood without using the key or the remote transmitter, will cause the alarm to activate. It also activates if the ignition switch is turned to the ON (II) position, the audio unit is removed from the dashboard or the wiring is cut.

The security system does not set if any door, the tailgate, or hood is not fully closed. Before you leave the vehicle, make sure the doors, tailgate and hood are securely closed.

To see if the system sets after you exit the vehicle, press the LOCK button on the remote transmitter within five seconds. If the system is set, the horn will beep once.

Do not attempt to alter this system or add other devices to it.

Compass

Compass Operation

On models without navigation system
Compass operation can be affected by driving near power lines or stations, across bridges, through tunnels, over railroad crossings, past large vehicles, or driving near large objects that can cause a magnetic disturbance. It can also be affected by accessories such as antennas and roof racks that are mounted by magnets.

Compass Calibration

If you see “--” in the compass display and “CAL” and “ㄟㄣㄣ” are shown in the calendar display, the compass is self-calibrating. The compass may need to be manually calibrated after exposure to a strong magnetic field. If the compass seems to be continually showing the wrong direction and is not self-calibrating, do the following.

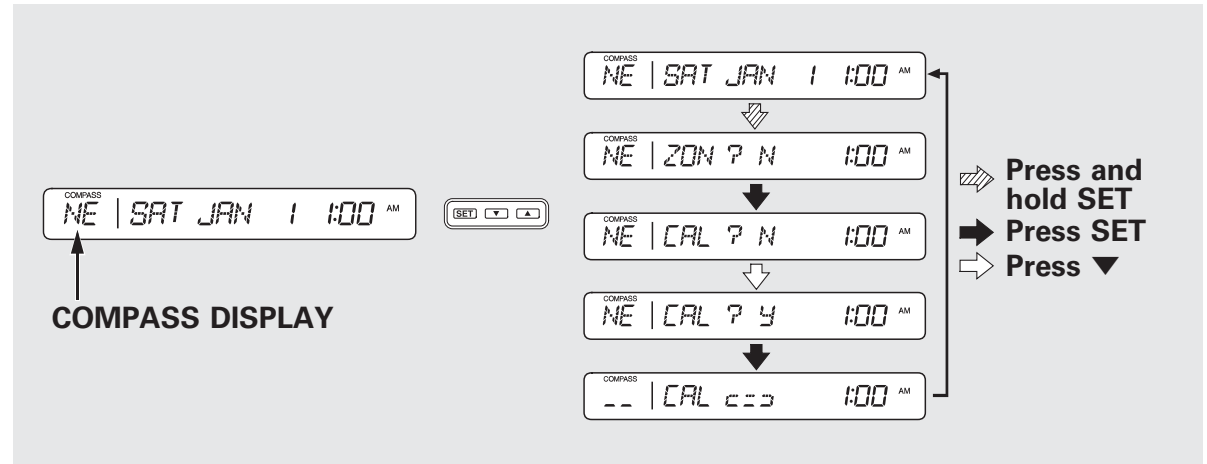

1. Press and hold the SET button for five seconds until the clock display changes to “ZON ? N.” (Clock adjustment mode will be started after the first two seconds.)
2. Press the SET button. “CAL ? N” will be displayed. At this point, pressing the SET button will exit calibration mode.
3. Press the ▼ button. “CAL ? Y” will be displayed.
4. Press the SET button. The compass display will change to “--” and “CAL” and “ㄟㄣㄣ” are shown.
5. Drive the vehicle slowly in two complete circles.

- When the display goes from “--” to an actual heading, the unit is calibrated and the display returns to normal.

NOTE: Do this procedure in an open area, away from buildings, power lines, and other vehicles.

Compass Zone Selection

In most areas, there is a variation between magnetic north and true north. Zone selection is required so the compass can compensate for this variation. To check and select the zone, do this:

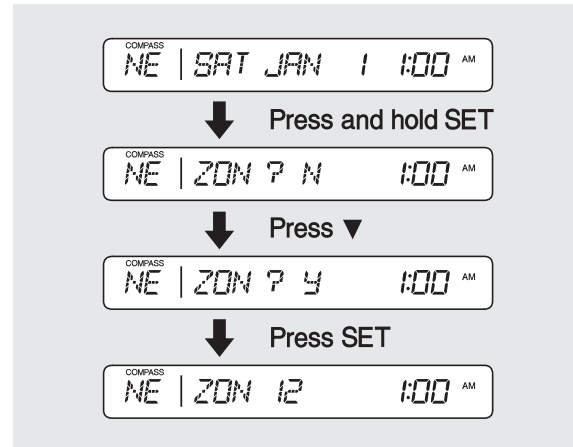

- Press and hold the SET button for five seconds until the clock display changes to “ZON ? N.” (Clock adjustment mode will be started after the first two seconds.)
- Press the ▼ button. “ZON ? Y” will be displayed.
- Press the SET button. The zone the compass is currently in will be displayed.

- Find the zone for your area on the map.
- If the zone is incorrect, press the ▼ button to cycle the count down, or the ▲ button to cycle the count up. Once the correct zone is displayed, continue to step 6.
- Press the SET button to set the zone selection.
- Press and hold the SET button for about 5 seconds to exit the zone selection and return display to normal.

CONTINUED

Compass

Zone Map

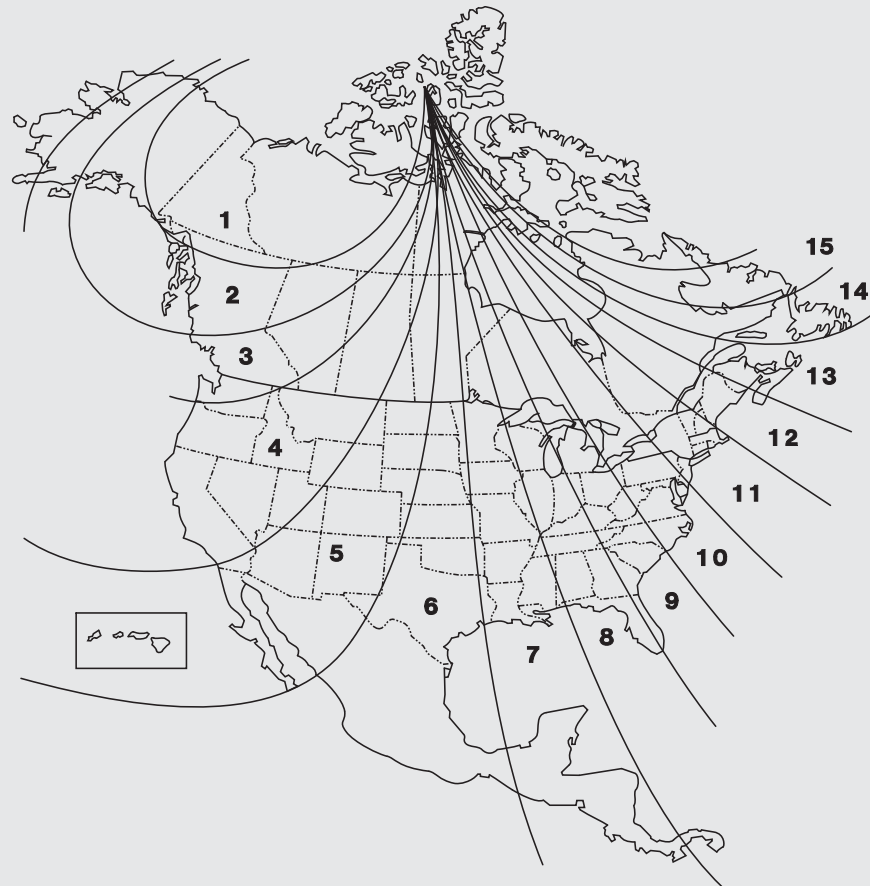

Cruise control allows you to maintain a set speed above 25 mph (40 km/h) without keeping your foot on the accelerator pedal. It should be used for cruising on straight, open highways. It is not recommended for city driving, winding roads, slippery roads, heavy rain, or bad weather.

⚠ WARNING

Improper use of the cruise control can lead to a crash.

Use the cruise control only when traveling on open highways in good weather.

Using Cruise Control

CRUISE (MAIN) BUTTON

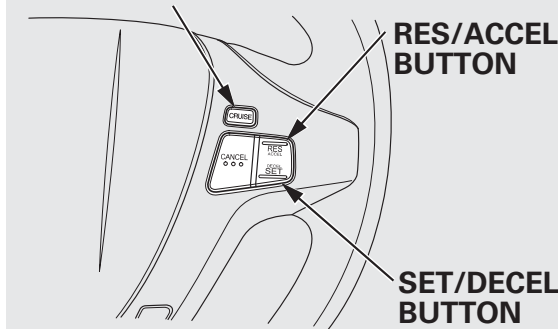

Non-ACC model is shown

1. Push in the CRUISE button or MAIN button (models with adaptive cruise control) on the steering wheel. The CRUISE MAIN indicator or green ACC indicator (models with ACC) on the instrument panel comes on.

On models with adaptive cruise control

To switch from ACC to cruise control, press the distance button on the steering wheel, and hold it for 1 second (see page 362).

2. Accelerate to the desired cruising speed above 25 mph (40 km/h).
3. Press and release the SET/DECEL button on the steering wheel. The CRUISE CONTROL indicator on the instrument panel comes on to show the system is now activated.

CONTINUED

Cruise Control

Cruise control may not hold the set speed when you are going up and down hills. If your vehicle speed increases going down a hill, use the brakes to slow down. This will cancel the cruise control. On models with adaptive cruise control (ACC), this also causes the cruise control indicator on the instrument panel to go off and the cruise mode indicator to come on. To resume the set speed, press the RES/ACCEL button. The CRUISE CONTROL indicator on the instrument panel will come back on.

Changing the Set Speed

You can increase the set cruising speed in any of these ways:

- Press and hold the RES/ACCEL button. When you reach the desired cruising speed, release the button.
- Push on the accelerator pedal. Accelerate to the desired cruising speed, then press the SET/DECEL button.
- To increase the speed in very small amounts, tap the RES/ACCEL button. Each time you do this, your vehicle will speed up about 1 mph (1.6 km/h).

You can decrease the set cruising speed in any of these ways:

- Press and hold the SET/DECEL button. Release the button when you reach the desired speed.
- To slow down in very small amounts, tap the SET/DECEL button. Each time you do this, your vehicle will slow down about 1 mph (1.6 km/h).
- Tap the brake pedal lightly with your foot. The CRUISE CONTROL indicator on the instrument panel will go out. When the vehicle slows to the desired speed, press the SET/DECEL button.

Even with cruise control turned on, you can still use the accelerator pedal to speed up for passing. After completing the pass, take your foot off the accelerator pedal. The vehicle will return to the set cruising speed.

Resting your foot on the brake pedal causes cruise control to cancel.

Canceling Cruise Control

CRUISE (MAIN) BUTTON

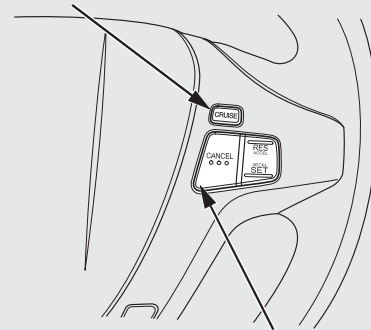

CANCEL BUTTON

Non-ACC model is shown

You can cancel cruise control in any of these ways:

- Tap the brake pedal.
- Push the CANCEL button on the steering wheel.
- Push the CRUISE (MAIN) button on the steering wheel.

Resuming the Set Speed

When you push the CANCEL button or tap the brake pedal, the system remembers the previously set speed. To return to that speed, accelerate to above 25 mph (40 km/h), then press and release the RES/ACCEL button. The CRUISE CONTROL [ACC (green)] indicator comes on. The vehicle accelerates to the same speed as before.

Pressing the CRUISE (MAIN) button turns the system completely off and erases the previous cruising speed.

Adaptive Cruise Control (ACC)

ACC Components

If equipped

Adaptive cruise control (ACC) consists of a radar sensor in the front grille, the MAIN buttons on the steering wheel, and the ACC functions of the multi-information display.

The radar sensor for ACC is shared with the collision mitigation braking system™ (CMBS™). For more information on the radar sensor, see page 464. For more information on CMBS, see page 463.

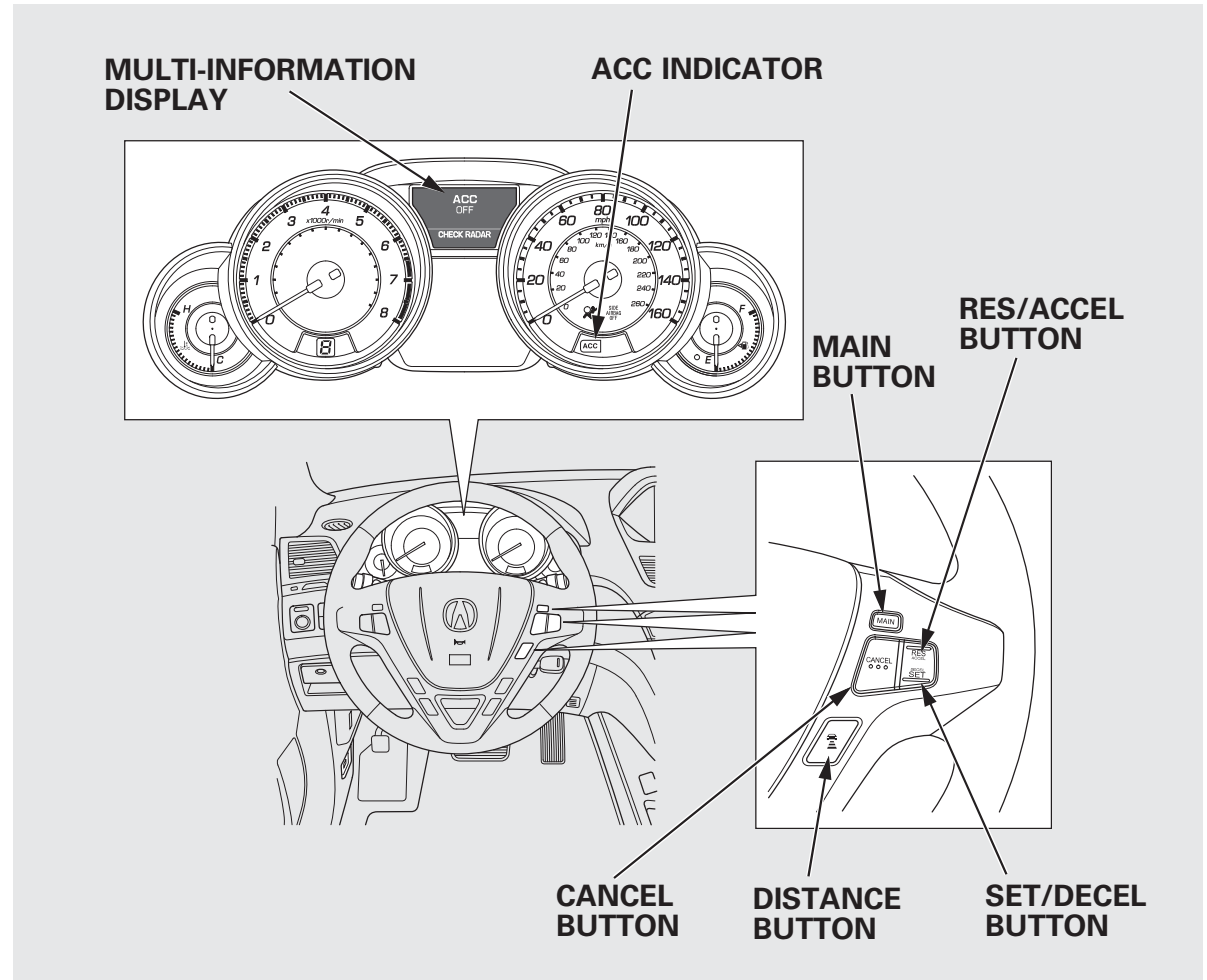

Overview

Adaptive cruise control (ACC) allows you to maintain a set speed and keep the vehicle ahead of you and your vehicle at a safe distance without having to use the accelerator pedal or the brake pedal.

When the vehicle ahead of you slows down or speeds up, ACC senses the change in distance and compensates by adjusting your vehicle speed accordingly. The distance between vehicles is based on your speed: the faster you go, the longer the distance will be; the slower you go, the shorter it will be.

If the vehicle ahead of you slows down suddenly or another vehicle cuts in front of your vehicle, ACC alerts you by sounding a beeper and displaying a message on the multi-information display.

The ACC radar sensor in the front grille can detect and monitor the distance of a vehicle up to 328 feet (100 meters) ahead of your vehicle. For more information on the radar sensor, see page 464.

Important Safety Precautions

As with any system, there are limits to ACC. Inappropriate use of ACC can result in a serious accident. Use the brake pedal whenever necessary, and always keep a safe distance between your vehicle and other vehicles.

Do not use ACC under these conditions:

- In poor visibility.
- In heavy traffic.
- When you must slow down and speed up repeatedly.
- On winding roads.
- When you enter a toll gate, interchange, service area, parking area, etc. In these areas, there is no vehicle ahead of you, but ACC would still try to accelerate to your set speed.
- In bad weather (rain, fog, snow, etc.)
- On a slippery road (for example a road covered with ice or snow).

CONTINUED

Adaptive Cruise Control (ACC)

⚠ WARNING

Improper use of ACC can lead to a crash.

Use ACC only when traveling on open highways in good weather.

Operating Characteristics

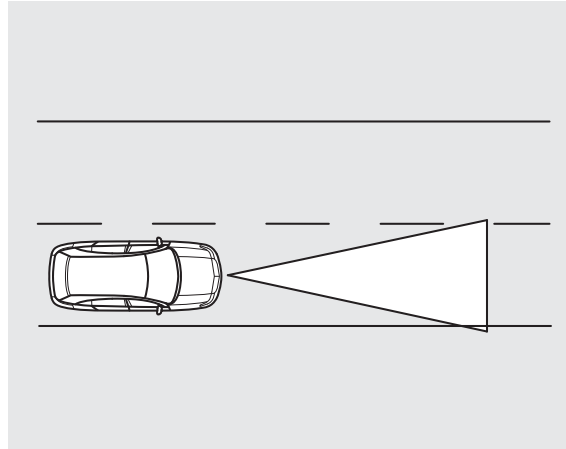

When there is no vehicle ahead within ACC range
Your vehicle will maintain a set cruising speed.

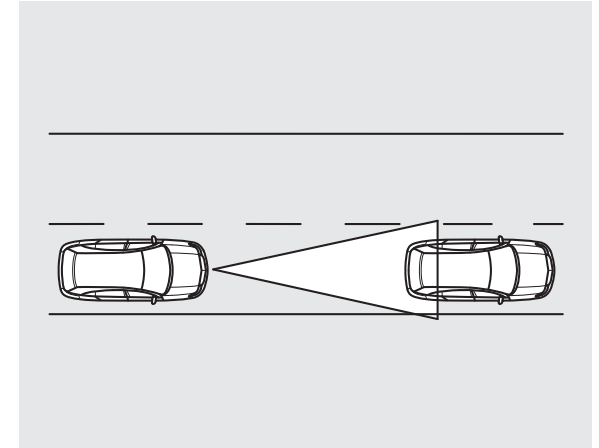

When a vehicle ahead is within ACC range and going slower than your set speed
If the vehicle ahead of you is going slower than your set speed, your vehicle will slow down to the speed of that vehicle. Your vehicle will then follow at a constant distance until the vehicle ahead changes speed again.

Adaptive Cruise Control (ACC)

If the vehicle ahead of you slows down abruptly, or if another vehicle cuts in front of you, a beeper sounds and a message appears on the multi-information display to warn you.

In this case, decelerate your vehicle by pressing the brake pedal, and keep an appropriate distance from the vehicle ahead.

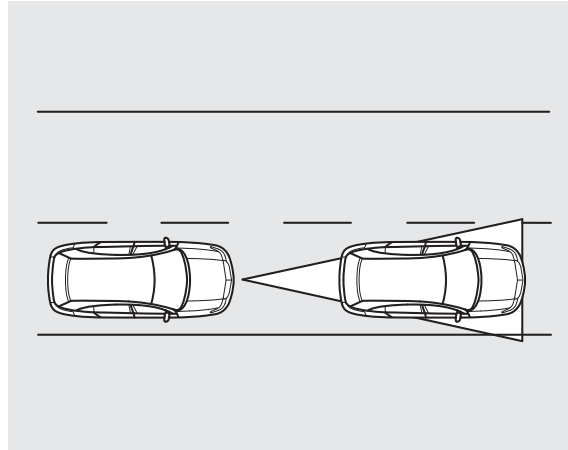

When a vehicle ahead is within ACC range and going at a steady speed
Your vehicle follows the vehicle ahead of it, keeping a constant distance. ACC will not keep your vehicle at a constant distance if the vehicle ahead of you goes out of range of your set speed.

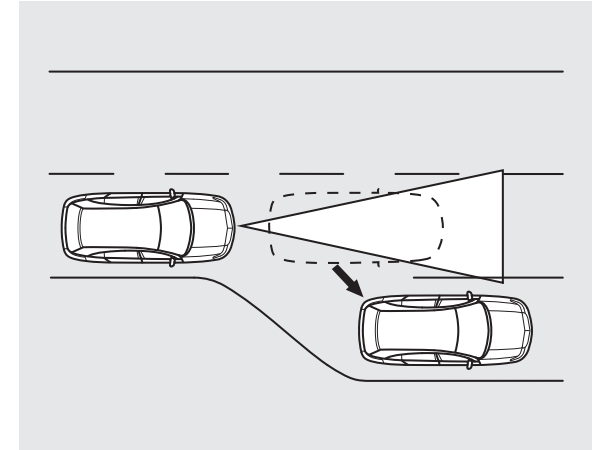

If the vehicle ahead of you slows down and changes lanes, ACC no longer tracks it. Your vehicle will then return to your set speed.

Adaptive Cruise Control (ACC)

Limitations

- ACC does not work below 25 mph (40 km/h). It cannot bring your vehicle to a complete stop.
 - ACC will not sound a beeper or display a message on the multi-information display to warn you of vehicles going slower than 13 mph (20 km/h) or vehicles that are parked. In these cases, it is up to you to maintain a safe distance by using the brake pedal.
 - ACC may not recognize motorcycles or other small vehicles ahead of your vehicle.
- ACC may react to vehicles beside you or even a building beside you by momentarily applying the brakes or sounding a beeper under conditions such as a sudden curve or narrowing of the road, an abrupt movement of the steering wheel, or if you are in an unusual position within your lane.

Adaptive Cruise Control (ACC)

Using the ACC

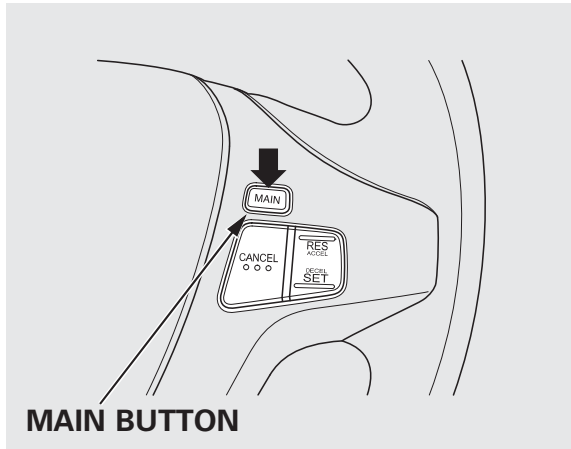

1. Push the MAIN button on the steering wheel. The ACC indicator on the instrument panel comes on, and “ACC” is shown on the multi-information display.
2. Accelerate to the desired speed above 25 mph (40 km/h).

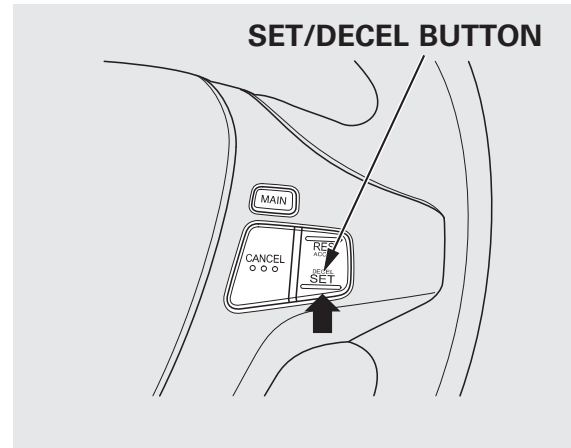

3. Press and release the SET/DECEL button on the steering wheel, then release the accelerator pedal.

If you press the SET/DECEL button when the vehicle speed is below 25 mph (40 km/h), you will hear a beep for about 1 second. This means ACC is not activated, and you cannot set your speed.

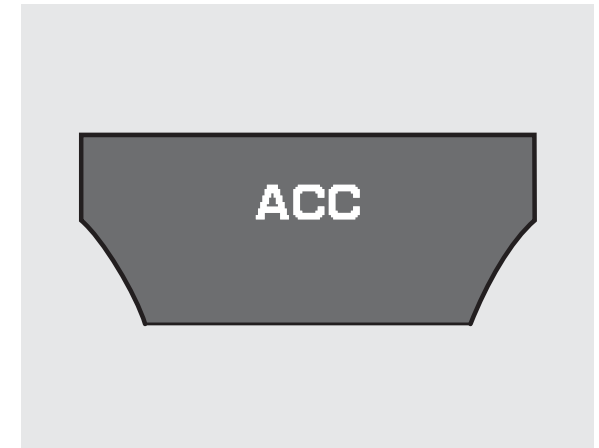

When your speed reaches 25 mph (40 km/h), ACC goes into wait mode, and “ACC” is shown on the multi-information display.

Adaptive Cruise Control (ACC)

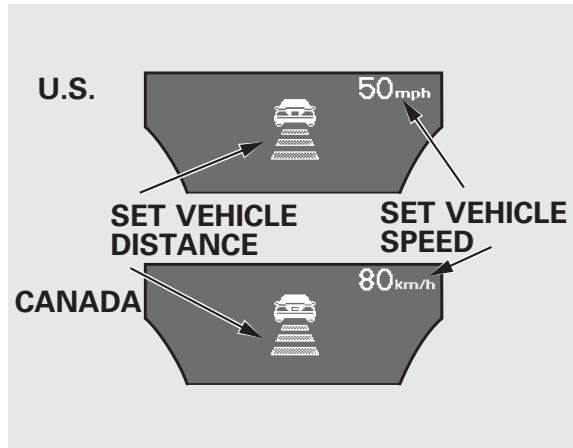

When the speed is set, it is shown along with a vehicle icon and distance bars on the multi-information display. Refer to page 357 for how to set and change the set distance between your vehicle and the vehicle ahead of you.

To change the speed unit measurement from mph to km/h, see page 98.

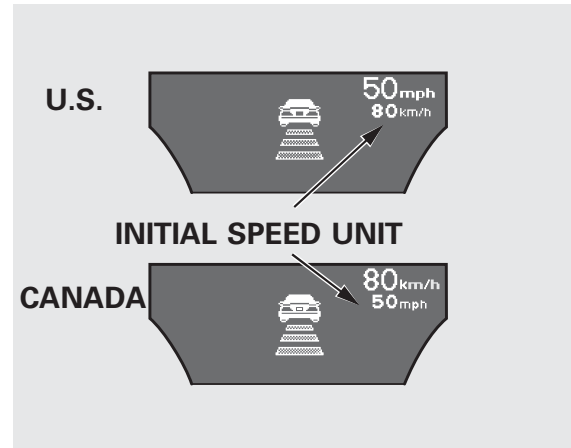

If you change the speed unit measurement from the factory default setting, the initial speed unit measurement is shown under the current unit.

Increasing the Set Speed

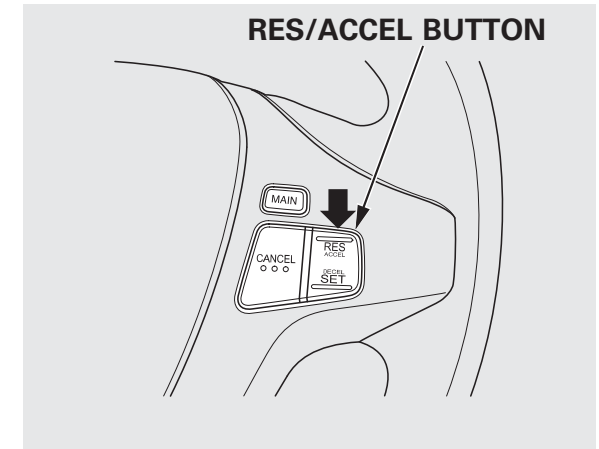

The set speed can be increased by using the RES/ACCEL button or the accelerator pedal.

To increase the set speed with the RES/ACCEL button, do this:

Press and hold the RES/ACCEL button. The vehicle will accelerate. When you reach the speed you want, release the button.

Adaptive Cruise Control (ACC)

To increase your speed in small amounts, tap the RES/ACCEL button repeatedly. Each time you do this, your vehicle will speed up about 1 mph (1 km/h).

While the vehicle accelerates to the set speed, the set speed on the multi-information display will flash.

If a vehicle ahead of you is driving at a slower speed than the speed you want to set, your vehicle will not accelerate; it will keep some distance between your vehicles.

To increase the set speed with the accelerator pedal, do this:

Press the accelerator pedal to increase to the speed you want, then press the SET/DECEL button. The set speed will be shown on the multi-information display. If you do not press the SET/DECEL button, your vehicle will return to the previously set speed.

The ACC beeper will not sound while you press the accelerator pedal, no matter how close you get to the vehicle ahead of you.

Decreasing the Set Speed

The set speed can be decreased using the SET/DECEL button or the brake pedal.

To decrease the set speed with the SET/DECEL button, do this:

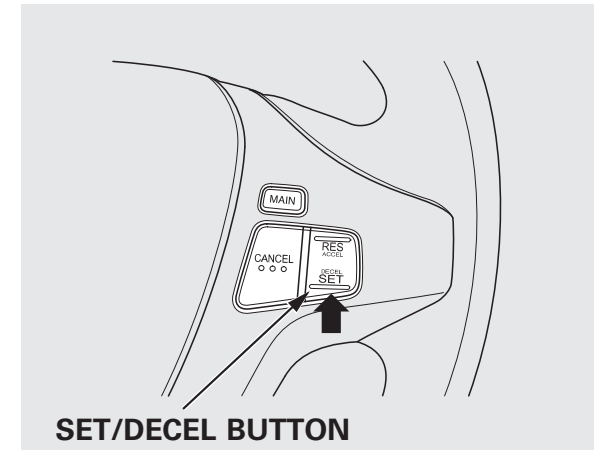

Press and hold the SET/DECEL button. Release the button when you reach the speed you want.

CONTINUED

Adaptive Cruise Control (ACC)

To slow down in small amounts, tap the SET/DECEL button repeatedly. Each time you do this, your vehicle slows down about 1 mph (1 km/h).

The set cruising speed will be shown on the multi-information display.

On a steep downhill, the vehicle speed may exceed the set cruising speed.

To decrease the set speed with the brake pedal, do this:

Tap the brake pedal. When the vehicle slows down to the speed you want, press the SET/DECEL button. The set speed will be shown on the multi-information display. If you use the brake pedal to decrease speed, and then press the RES/ACCEL button, your vehicle will return to the previously set speed.

Detecting a Vehicle Ahead of You

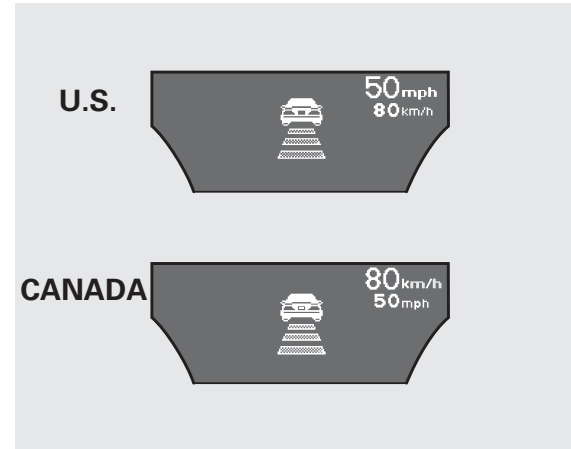

When the system detects a vehicle ahead of you, a beeper sounds once and a solid-line vehicle icon appears on the multi-information display.

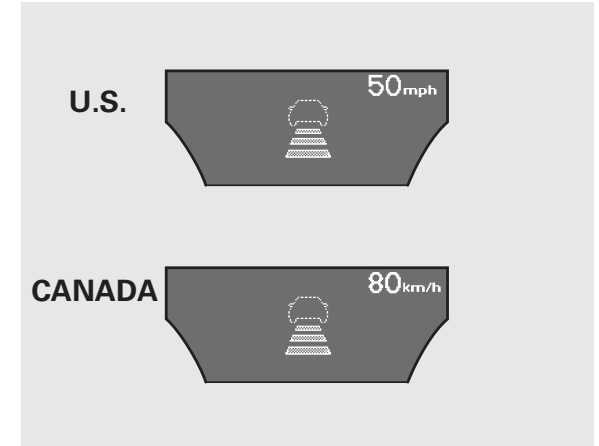

When that vehicle changes lanes or goes out of ACC range, a beeper sounds once. If there is no vehicle ahead of you within ACC range, a dotted-line vehicle icon will be on the multi-information display.

To set the ACC beeper on or off, see page 97.

Changing Vehicle Distance

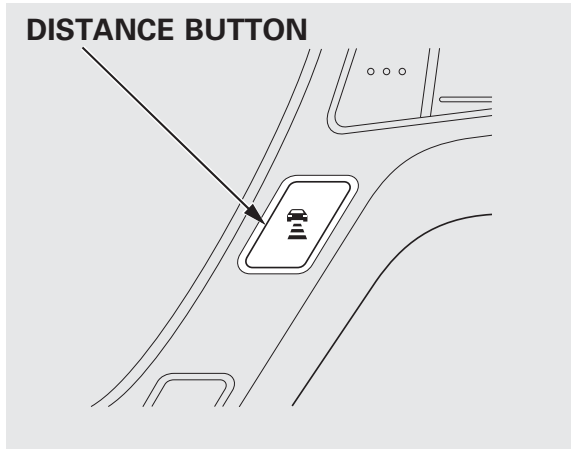

With ACC on, the distance between your vehicle and the vehicle ahead of you is controlled and maintained. You can change this distance to one of three ranges: long, middle, or short.

To change the range, press the distance button. Each time you press the button, the range changes from Long, to Middle, and then to Short.

The higher your vehicle speed is, the longer the distance between the vehicle in front will be set as shown below.

Speed	50 mph (80 Km/h)	65 mph (104 Km/h)
Vehicle Distance		
Long	154 feet 47 meters	200 feet 61 meters
Middle	111 feet 34 meters	173 feet 42 meters
Short	85 feet 26 meters	101 feet 31 meters

The distance you select is also shown on the multi-information display.

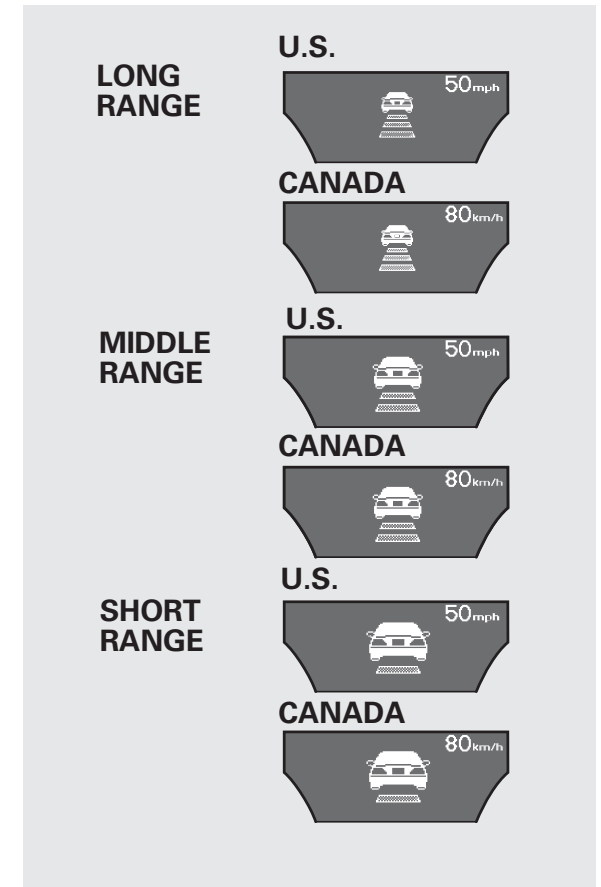

Features

CONTINUED

Adaptive Cruise Control (ACC)

Canceling the ACC

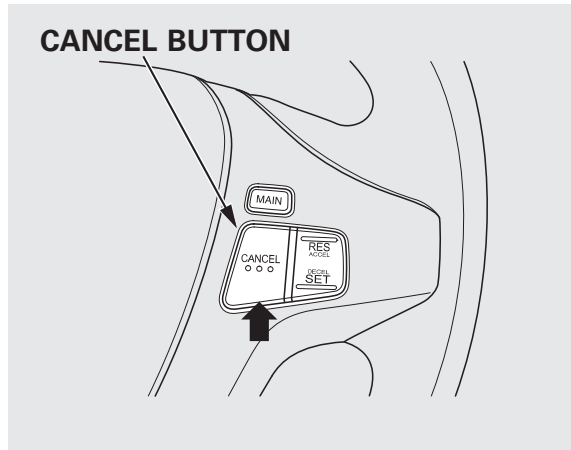

ACC is canceled whenever you do any of these actions:

- Push the CANCEL button on the steering wheel.
- Tap the brake pedal.
- Press the MAIN button. The ACC indicator in the instrument panel goes off.

When you push the CANCEL button or tap the brake pedal to cancel ACC, the set cruising speed stays in memory. When you turn on ACC again, the speed is shown on the multi-information display. To return to that speed, accelerate to over 25 mph (40 km/h), then press the RES/ACCEL button.

If you cancel ACC by pressing the MAIN button, the previously set cruising speed is erased from memory.

Automatic ACC Cancellation

When ACC is automatically canceled, the beeper sounds for about 1 second, and the ACC OFF message appears on the multi-information display for 3 seconds.

Any of these conditions may cause ACC to cancel:

- The vehicle speed decreases below 22 mph (35 km/h).
- Poor weather (rain, fog, snow, etc.)
- When the radar sensor in the front grille gets dirty.
- The vehicle ahead of you cannot be detected.
- An abnormal tire condition is detected, or the tires are skidding.

- Driving on a mountainous road, or driving off road for extended periods.
- Abrupt steering wheel movement.
- When the ABS or VSA is activated.
- When the VSA indicator comes on.

If ACC is canceled by any these conditions, wait until the condition improves, then press the RES/ACCEL button to restore ACC. When you do this, the vehicle will resume its set cruising speed.

If you turn the ignition switch to the ACCESSORY (I) or LOCK (0) position after ACC was automatically canceled, the set speed is erased, and you must enter it again (see page 353).

ACC Indicator

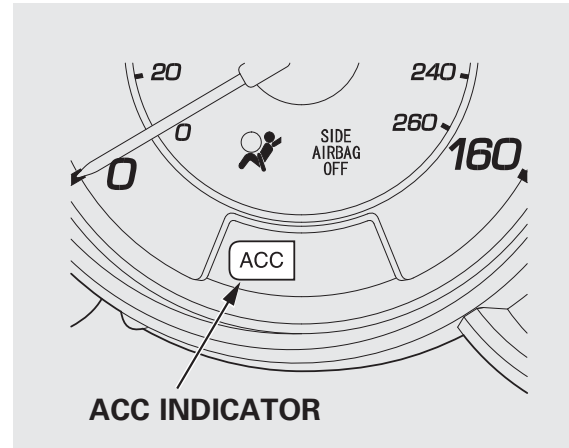

The ACC amber indicator normally comes on for a few seconds when you turn the ignition switch to the ON (II) position. If it comes on at any other time, there is a problem in the ACC system. If this happens, take the vehicle to your dealer to have it checked.





The ACC system cannot be used while this amber indicator is on.

CONTINUED



Adaptive Cruise Control (ACC)

Messages on the Multi-Information Display

The multi-information display shows various messages related to ACC. For a description of each ACC message you may see, refer to the chart on this and the following page.

Message	Description
	ACC is on.
<p>U.S.</p>  <p>CANADA</p> 	<p>ACC detects a vehicle ahead of you.</p> <p>You will hear a beep when the vehicle moves out of the ACC radar sensor's range.</p>
<p>U.S.</p>  <p>CANADA</p> 	<p>ACC does not detect a vehicle ahead of you.</p> <p>You will hear a beep when ACC detects a vehicle ahead of you.</p>

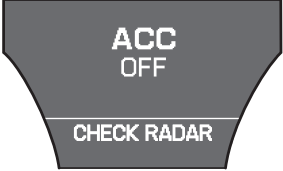
Adaptive Cruise Control (ACC)

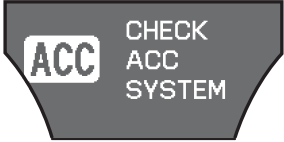
Message	Description	Message	Description
 <p>ACC OFF CHECK RADAR</p>	<p>ACC has automatically canceled because its radar sensor in the front grille is dirty.</p> <p>You will hear three beeps.</p>	 <p>BRAKE</p>	<p>Apply the brakes immediately. Your vehicle is too close to the vehicle ahead of it.</p> <p>You will hear a continuous beep.</p>
 <p>ACC OFF</p>	<p>ACC has automatically canceled because of bad weather or other conditions.</p> <p>You will hear three beeps.</p>	 <p>ACC CHECK ACC SYSTEM</p>	<p>ACC needs to be checked.</p> <p>Have your vehicle checked by a dealer.</p>

CONTINUED

Adaptive Cruise Control (ACC)

Switching to Cruise Control

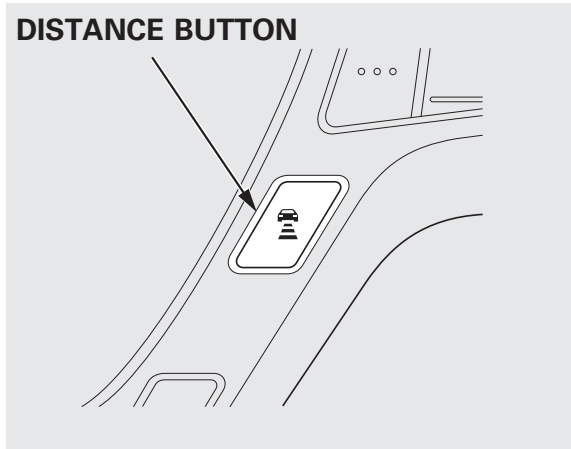

To switch from ACC to cruise control, press the distance button on the steering wheel, and hold it for 1 second.

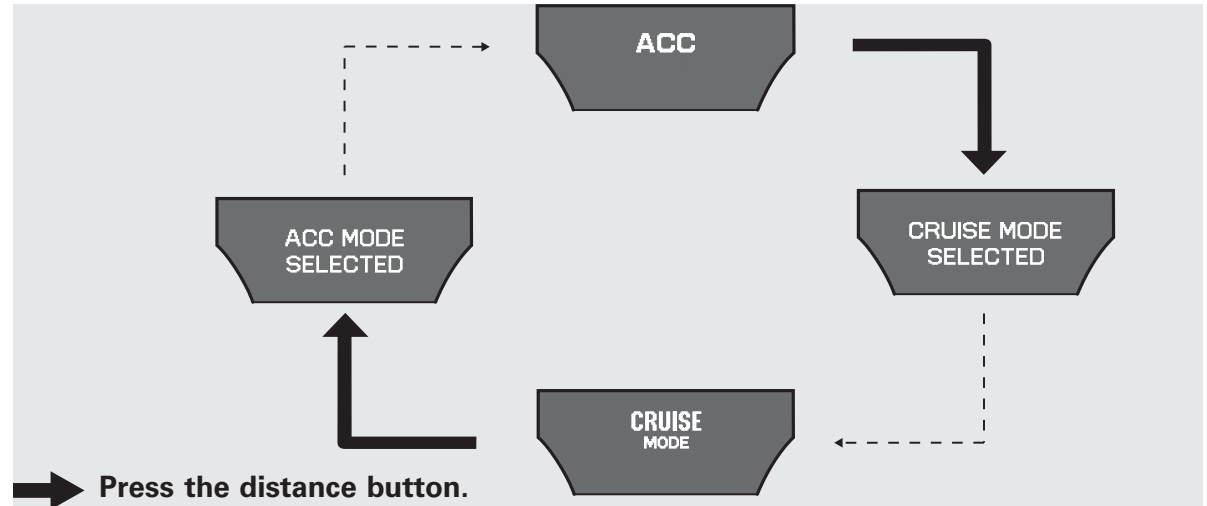

When you press the button, you will see **CRUISE MODE SELECTED** on the multi-information display for 2 seconds. To switch back to ACC, press and hold the distance button again for 1 second.

When the cruise control is selected, ACC does not sound a beeper or display a message on the multi-information display. Make sure to keep a safe distance from the vehicle ahead of you.

Always be aware which mode is selected.

The HomeLink® Universal Transceiver built into your vehicle can be programmed to operate up to three remote controlled devices around your home, such as garage doors, lighting, or home security systems.

General Safety Information

Before programming your HomeLink to operate a garage door opener, confirm that the opener has an external entrapment protection system, such as an “electronic eye,” or other safety and reverse stop features.

If your garage door was manufactured before April 1, 1982, you may not be able to program HomeLink to operate it. These units do not have safety features that cause the motor to stop and reverse it if an obstacle is detected during closing, increasing the risk of injury. Do not use HomeLink with any garage door opener that lacks safety stop and reverse features.

Units manufactured between April 1, 1982 and January 1, 1993 may be equipped with safety stop and reverse features. If your unit does not have an external entrapment protection system, an easy test to confirm the function and performance of the safety stop and reverse feature is to lay a 2 × 4 under the closing door. The door should stop and reverse upon contacting the piece of wood. As an additional safety feature, garage door openers manufactured after January 1, 1993 are required to have external entrapment protection systems, such as an electronic eye, which detect an object obstructing the door.

Important Safety Precautions

Refer to the safety information that came with your garage door opener to test that the safety features are functioning properly. If you do not have this information, contact the manufacturer of the equipment.

Before programming HomeLink to a garage door or gate opener, make sure that people and objects are out of the way of the device to prevent potential injury or damage.

When programming a garage door opener, park just outside the garage.

Training HomeLink

Before you begin – If you just received your vehicle and have not trained any of the buttons in HomeLink before, you should erase any previously learned codes before training the first button.

To do this, press and hold the two outside buttons on the HomeLink transceiver for about 20 seconds, until the red indicator flashes. Release the buttons, then proceed to step 1.

CONTINUED

HomeLink® Universal Transceiver

If you are training the second or third buttons, go directly to step 1.

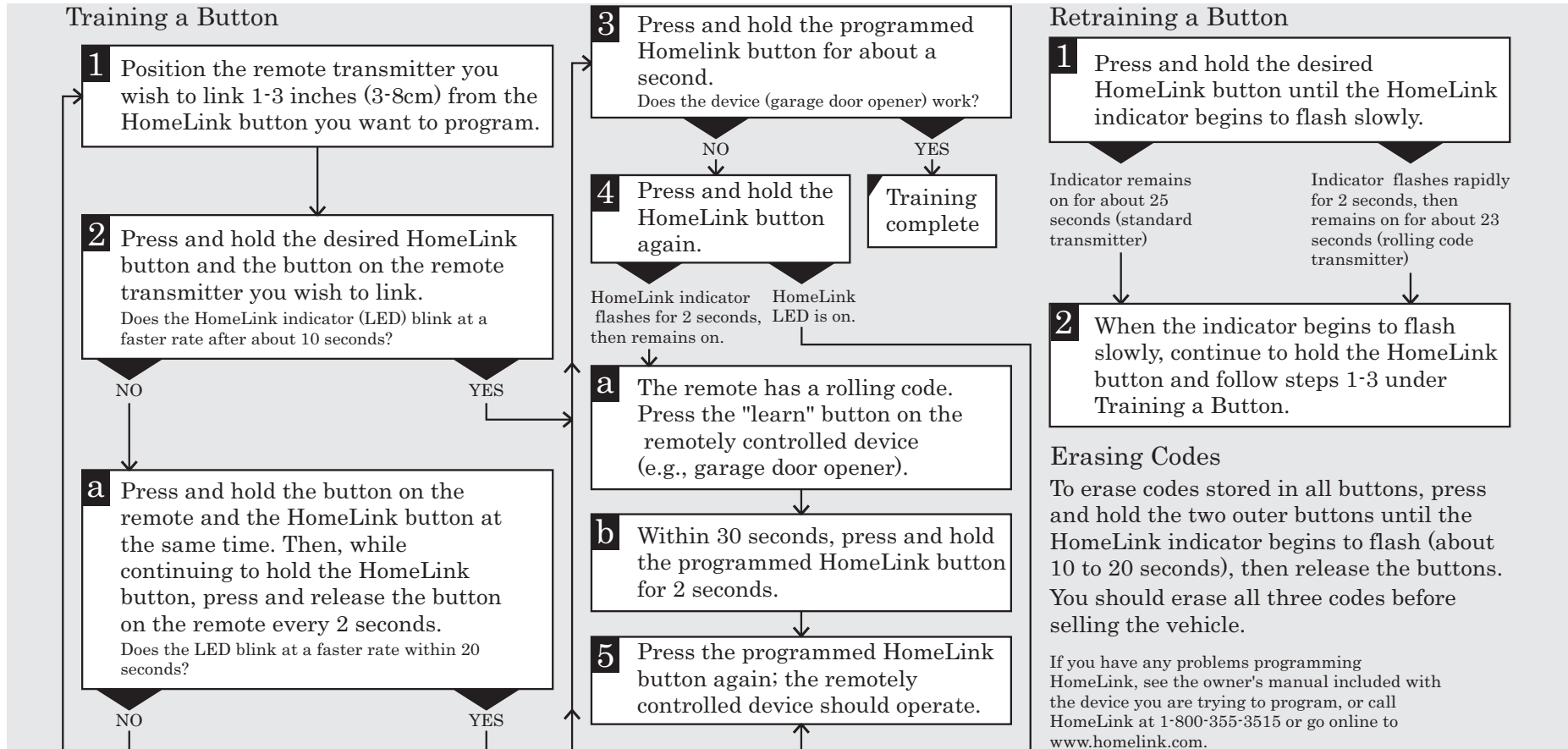

HomeLink® Universal Transceiver, *Bluetooth*® HandsFreeLink® (Models without navigation system)

HomeLink® is a registered trademark of Johnson Controls, Inc.

As required by the FCC:

This device complies with Part 15 of the FCC rules. Operation is subject to the following two conditions: (1) This device may not cause harmful interference, and (2) this device must accept any interference received, including interference that may cause undesired operation.

Changes or modifications not expressly approved by the party responsible for compliance could void the user's authority to operate the equipment.

This device complies with Industry Canada Standard RSS-210.

Operation is subject to the following two conditions: (1) this device may not cause interference, and (2) this device must accept any interference that may cause undesired operation of the device.

***Bluetooth*® HandsFreeLink® (Models without navigation system)**

Bluetooth® HandsFreeLink® (HFL) allows you to place and receive phone calls using voice commands, without handling your cell phone. To use HFL, you need a Bluetooth-compatible cell phone. For a list of compatible phones, pairing procedures, and special feature capabilities:

In the U.S., visit www.acura.com/handsfreelink, or call (888) 528-7876.

In Canada, visit www.handsfreelink.ca, or call (888) 528-7876.

CONTINUED

Bluetooth® HandsFreeLink® (Models without navigation system)

Using HFL

HFL Buttons

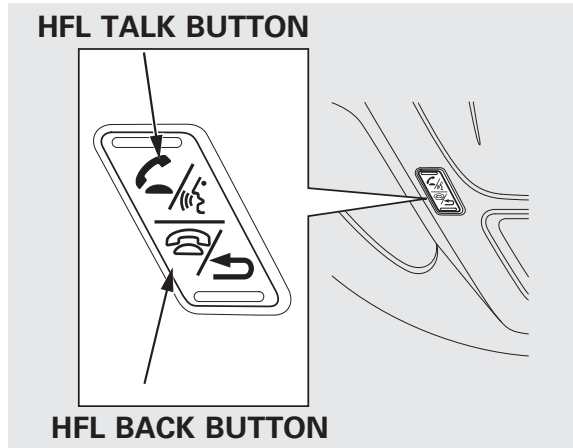

HFL Talk button – Press and release to give a command or answer a call.

HFL Back button – Press and release to end a call, go back to the previous command, or cancel the command.

Voice Control Tips

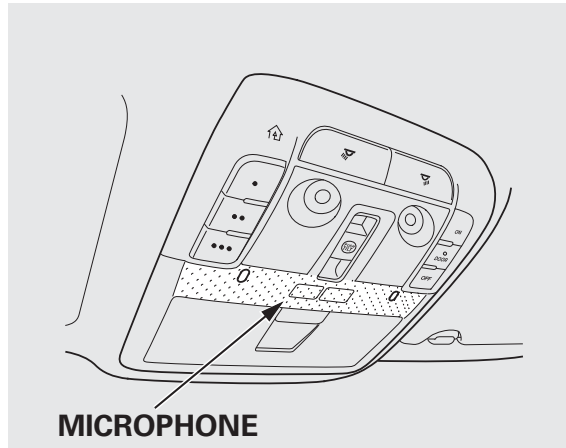

- Air or wind noise from the dashboard and side vents and all windows may interfere with the microphone. Adjust or close them as necessary.

- Press and release the HFL Talk button each time you want to make a command. After the beep, speak in a clear, natural tone.
- Try to reduce all background noise. If the microphone picks up voices other than yours, commands may be misinterpreted.
- Many commands can be spoken together. For example, you can say “Call 123-456-7890” or “Dial Peter.”

Bluetooth® HandsFreeLink® (Models without navigation system)

- To change the volume level of HFL, use the audio system volume knob or the steering wheel volume controls.

Help Features

- To hear general HFL information, including help on pairing a phone or setting up the system, say “**Tutorial.**”
- For help at any time, including a list of available commands, say “**Hands free help.**”

Information Display

As an incoming call notification, you will see the following display:

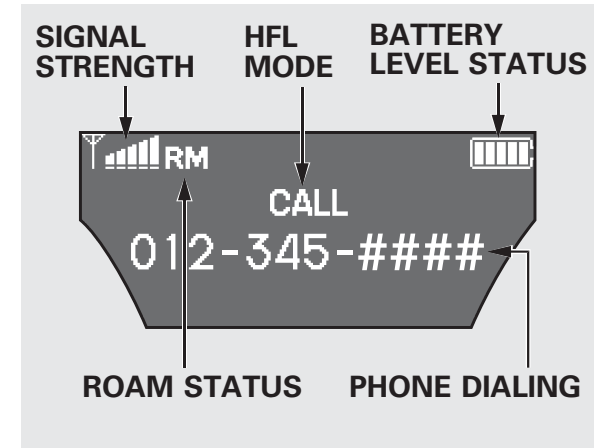

CONTINUED

Bluetooth[®] HandsFreeLink[®] (Models without navigation system)

Some phones may send battery, signal strength, and roaming status information to HFL.



You will see “HANDSFREELINK” and the “” indicator on the audio display when you operate HFL.

Bluetooth® HandsFreeLink® (Models without navigation system)

How to Use HFL

The ignition switch must be in the ACCESSORY (I) or ON (II) position.

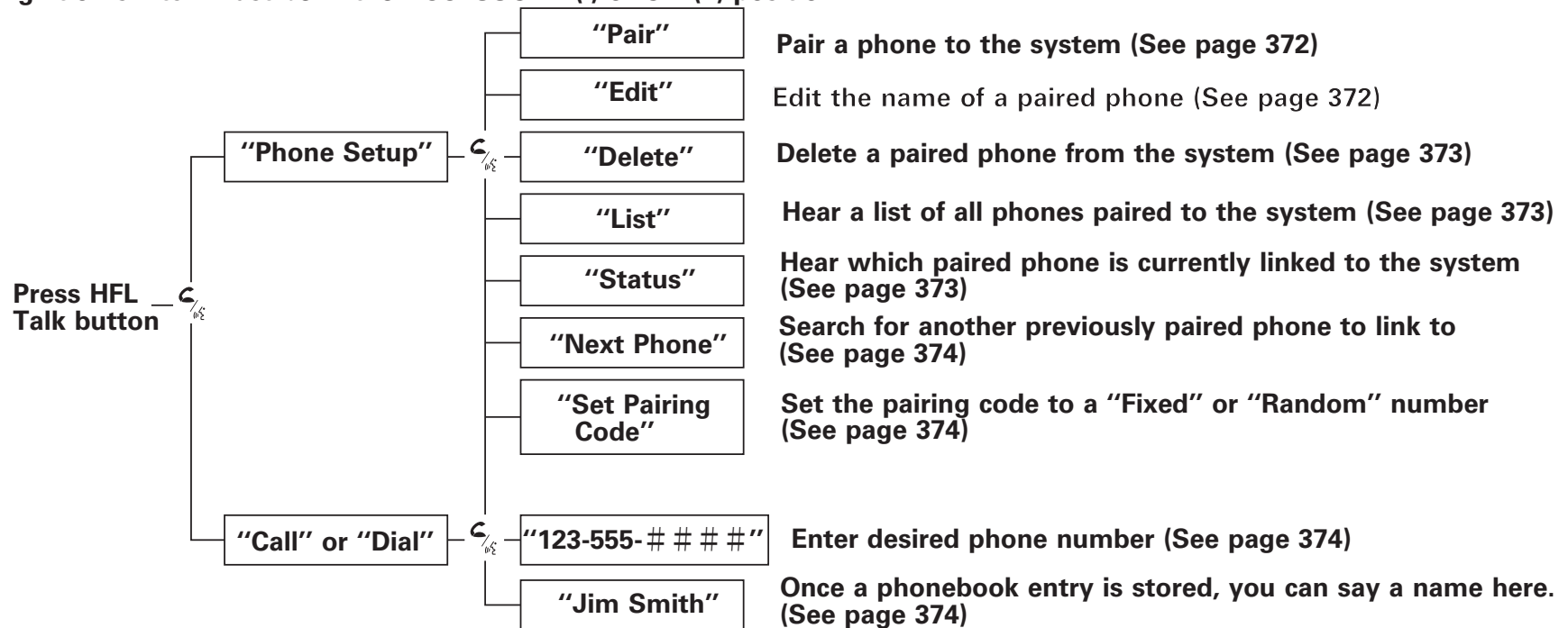

 Press and release the HFL Talk button each time you give a command.

CONTINUED

Bluetooth® HandsFreeLink® (Models without navigation system)

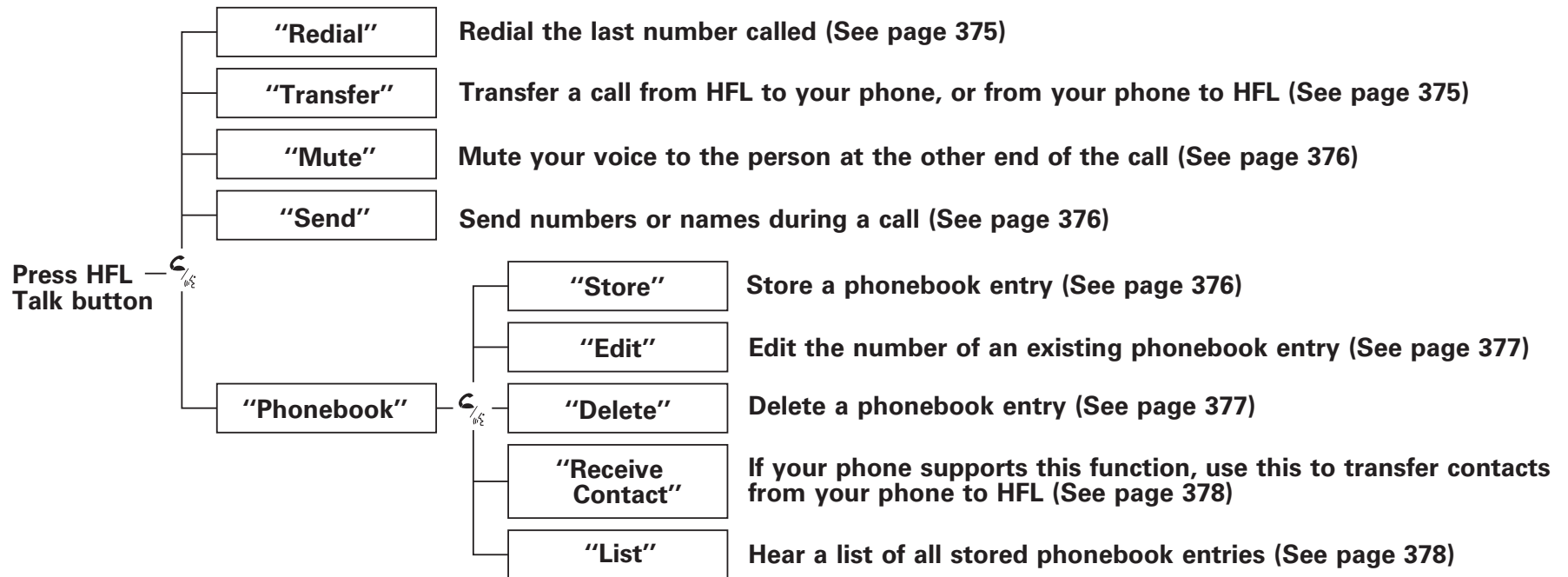

 Press and release the HFL Talk button each time you give a command.

Bluetooth® HandsFreeLink® (Models without navigation system)

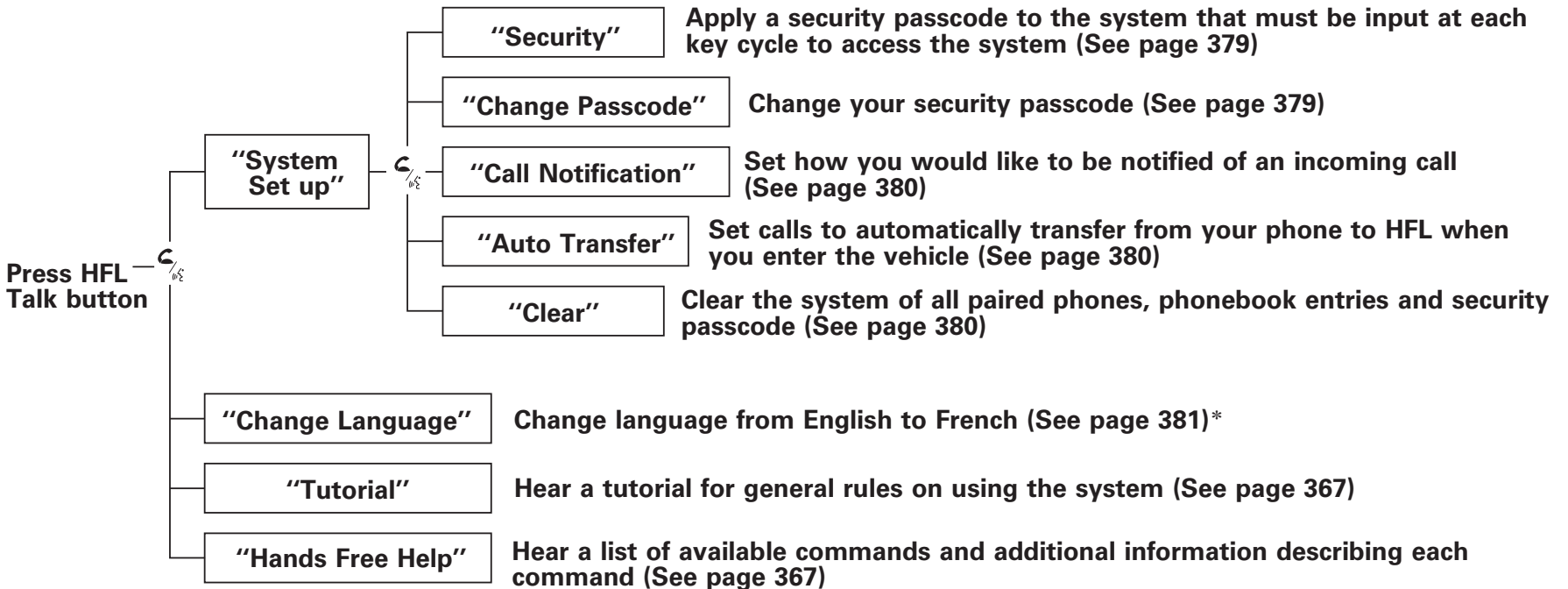

 Press and release the HFL Talk button each time you give a command.

* : Canadian models

CONTINUED

Bluetooth® HandsFreeLink® (Models without navigation system)

To use HFL, you need to pair your Bluetooth-compatible cell phone to the system.

Phone Setup

This command group is available for paired cell phones.

Phone pairing tips

- You cannot pair your phone while the vehicle is moving.
- Your phone must be in discovery or search mode to pair. Refer to your phone's manual.
- Up to six phones can be paired.
- Your phone's battery may drain faster when it is paired to HFL.
- If after three minutes your phone is not ready to pair or a phone is not found, the system will time out and return to idle.

To pair a cell phone:

1. Press and release the HFL Talk button. If you are pairing a phone for the first time, HFL will give you information about the pairing process. If it is not the first phone you are pairing, say “**Phone setup**” and say “**Pair.**”
2. Follow the HFL prompts and put your phone in discovery or search mode. HFL will give you a 4-digit pairing code and begin searching for your phone.
3. When your phone finds a Bluetooth device, select HFL from the options and enter the 4-digit code from the previous step.
4. Follow the HFL prompts and name the newly paired phone.

To rename a paired phone:

Press and release the HFL Talk button before a command.

1. Say “**Phone setup.**”
2. Say “**Edit**” after the prompts.
3. If there is more than one phone paired to the system, HFL will ask you which phone's name you want to change. Follow the HFL prompts and rename the phone.

Bluetooth® HandsFreeLink® (Models without navigation system)

To delete a paired phone:

Press and release the HFL Talk button before a command.

1. Say “**Phone setup.**”
2. Say “**Delete**” after the prompts.
3. HFL will ask you which phone you want to delete. Follow the HFL prompts to continue with the deletion.

To hear the names of all paired phones:

Press and release the HFL Talk button before a command.

1. Say “**Phone setup.**”
2. Say “**List**” after the prompts.
3. HFL will read out all the paired phone's names.

To hear which paired phone is currently linked:

Press and release the HFL Talk button before a command.

1. Say “**Phone setup.**”
2. Say “**Status**” after the prompts.
3. HFL will tell you which phone is linked to the system.

CONTINUED

Bluetooth® HandsFreeLink® (Models without navigation system)

To change from the currently linked phone to another paired phone:

Press and release the HFL Talk button before a command.

1. Say “**Phone setup.**”
2. Say “**Next phone**” after the prompts.
3. HFL disconnects the linked phone and searches for another paired phone.
4. Once another phone is found, it is linked to the system. HFL will inform you which phone is now linked.

If no other phones are found or paired, HFL will inform you that the original phone is linked again.

To change the pairing code setting:

Press and release the HFL Talk button before a command.

1. Say “**Phone setup.**”
2. Say “**Set pairing code**” after the prompts.
3. If you want HFL to create a random code each time you pair a phone, say “**Random.**” If you want to choose your own 4-digit code to be used each time, say “**Fixed**” and follow the HFL prompts.

Making a Call

You can make calls using a name in the HFL phonebook or any phone number. You can also redial the last number called.

HFL uses a Class 2 Bluetooth, which means the maximum range between your phone and vehicle is 30 feet (10 meters).

During a call, HFL allows you to talk up to 30 minutes after you remove the key from the ignition switch. However, this may weaken the vehicle's battery.

Bluetooth® HandsFreeLink® (Models without navigation system)

To make a call using a name in the HFL phonebook:

Press and release the HFL Talk button before a command.

1. Say “**Call**” or “**Dial.**”
2. Follow the HFL prompts and say the name stored in the HFL phonebook that you want to call.
3. Follow the HFL prompts to confirm the name and make the call.

To make a call using a phone number:

Press and release the HFL Talk button before a command.

1. Say “**Call**” or “**Dial.**”
2. Follow the HFL prompts and say the phone number you want to dial.
3. Follow the HFL prompts to confirm the number and say “**Call**” or “**Dial.**”

Once connected, you will hear the person you called through the audio speakers.

To redial the last number called by HFL:

Press and release the HFL Talk button and say “**Redial.**”

Transferring a Call

You can transfer a call from HFL to your phone, or from your phone to HFL.

Press and release the HFL Talk button and say “**Transfer.**”

CONTINUED

Bluetooth® HandsFreeLink® (Models without navigation system)

Muting a Call

You can mute your voice to the person you are talking to during a call.

To mute your voice during a call, press and release the HFL Talk button and say “**Mute.**”

To unmute your voice, press and release the HFL Talk button and say “**Mute**” again.

Send Numbers or Names During a Call

HFL allows you to send numbers or names during a call. This is useful when you call a menu-driven phone system.

To send a name or number during a call:

Press and release the HFL Talk button before a command.

1. Say “**Send.**”
2. Follow the HFL prompts and say the name or number you want to send.
3. Follow the HFL prompts to send the tones and continue the call.

NOTE: To send a pound (#), say “pound.” To send a star (*), say “star.”

Phonebook

You can store up to 50 names with their associated numbers in HFL. The numbers you store cannot only be phone numbers but other types, such as account numbers or passwords, which can be sent during a menu-driven call.

To store a phonebook entry:

Press and release the HFL Talk button before a command.

1. Say “**Phonebook.**”
2. Say “**Store**” after the prompts.
3. Say a name you want to list as your phonebook entry.
4. Say the number you want to store for the name entry.
5. Follow the HFL prompts and say “**Enter**” to store the entry.

Bluetooth® HandsFreeLink® (Models without navigation system)

NOTE:

- Avoid using duplicate name entries.
- Avoid using “home” as a name entry.
- It is easier for HFL to recognize a multisyllabic or longer name. For example, use “Peter” instead of “Pete,” or “John Smith” instead of “John.”

To edit the number stored in a name:

Press and release the HFL Talk button before a command.

1. Say “**Phonebook.**”
2. Say “**Edit**” after the prompts.
3. Follow the HFL prompts and say the name entry you want to edit.
4. When asked, say the new number for that name.
5. Follow the HFL prompts to complete the edit.

To delete a name:

Press and release the HFL Talk button before a command.

1. Say “**Phonebook.**”
2. Say “**Delete**” after the prompts.
3. Say the name you want to delete and follow the HFL prompts to complete the deletion.

CONTINUED

Bluetooth® HandsFreeLink® (Models without navigation system)

To list all names in the phonebook:

Press and release the HFL Talk button before a command.

1. Say “**Phonebook.**”
2. Say “**List**” after the prompts.
3. HFL begins reading the names in the order they were stored.
4. If you hear a name you want to call, immediately press the HFL Talk button and say “**Call.**”

To store a specific phone number from your cell phone directly to the HFL phonebook (available on some phones):

Press and release the HFL Talk button before a command.

1. Say “**Phonebook.**”
2. Say “**Receive contact**” after the prompts.
3. Follow the HFL prompts, select a number from your cell phone, and send it to HFL.
4. Follow the HFL prompts and name the number, or say “**Discard**” if it is not the number you want to store.
5. Follow the HFL prompts if you want to store another number.

System Setup

This command group allows you to change or customize HFL basic settings.

Bluetooth® HandsFreeLink® (Models without navigation system)

To set a 4-digit passcode to lock the HFL system for security purposes:

Press and release the HFL Talk button before a command.

1. Say “**System setup.**”
2. Say “**Security**” after the prompts.
3. Follow the HFL prompts and say the 4-digit passcode you want to set.
4. Follow the HFL prompts to confirm the number.

NOTE: Once a passcode is set, you will need to enter it to use HFL each time you start the vehicle. If you forget the code, your dealer will have to reset it for you, or you will have to clear the entire system (see page 380).

To change your security pass code:
Press and release the HFL Talk button before a command.

1. Say “**System setup.**”
2. Say “**Change passcode**” after the prompts.
3. Follow the HFL prompts and say the new 4-digit passcode.
4. Follow the HFL prompts to confirm the number.

CONTINUED

Bluetooth® HandsFreeLink® (Models without navigation system)

To select either a ring tone or a prompt as the incoming call notification*:

Press and release the HFL Talk button before a command.

1. Say “**System setup.**”
2. Say “**Call notification**” after the prompts.
3. Follow the HFL prompts and say “**Ring tone**” or “**Prompt.**” You can also say “**Off**” for no audible incoming call notification.

*: The default setting is a ring tone.

To activate or deactivate the auto transfer function:

If you get into the vehicle while you are on the phone, the call can be automatically transferred to HFL with the ignition switch in the ACCESSORY (I) or ON (II) position.

Press and release the HFL Talk button before a command.

1. Say “**System setup.**”
2. Say “**Auto transfer**” after the prompts.
3. HFL will let you know if auto transfer is on or off, depending on the previous setting. Follow the HFL prompts to change the setting.

To clear the system:

This operation clears the passcodes, paired phones, and all names in the HFL phonebook data.

Press and release the HFL Talk button before a command.

1. Say “**System setup.**”
2. Say “**Clear**” after the prompts.
3. Follow the HFL prompts to continue to complete the clearing procedure.

You can also clear the system when you have forgotten the passcode and cannot access HFL. When HFL asks you for the passcode, say “**System clear.**” Paired phones, all names in the HFL phonebook data will be lost.

Bluetooth[®] HandsFreeLink[®] (Models without navigation system)

Quick Language Selection Canadian models only

To quickly change the language:
Press and release the HFL Talk button before a command.

1. Say the language you want to change to in that language.
2. Follow the HFL prompts.

Change Language Canadian models only

To change the system language between English and French:
Press and release the HFL Talk button before a command.

1. Say “**Change language.**”
2. Follow the HFL prompts to change the language to English or French.

If you have not named your paired phone in the language you just selected, HFL will ask you to name it in the current language.

When French is your currently selected language, you can give voice commands in French.

***Bluetooth*[®] Wireless Technology**
The *Bluetooth*[®] name and logos are registered trademarks owned by Bluetooth SIG, Inc. and any use of such marks by Honda Motor Co., Ltd. is under license. Other trademarks and trade names are those of their respective owners.

CONTINUED

Bluetooth® HandsFreeLink® (Models without navigation system)

As required by the FCC:

This device complies with Part 15 of the FCC rules. Operation is subject to the following two conditions: (1) This device may not cause harmful interference, and (2) this device must accept any interference received, including interference that may cause undesired operation.

Changes or modifications not expressly approved by the party responsible for compliance could void the user's authority to operate the equipment.

This device complies with Industry Canada Standard RSS-210.

Operation is subject to the following two conditions: (1) this device may not cause interference, and (2) this device must accept any interference that may cause undesired operation of the device.

Bluetooth® HandsFreeLink® (Models with navigation system)

Bluetooth® HandsFreeLink® (HFL) allows you to place and receive phone calls using either the navigation system controls or voice commands without the distraction of handling your cell phone. To use HFL, you need a Bluetooth-compatible cell phone. For a list of compatible phones, pairing procedures, and special feature capabilities:

In the U.S., visit www.acura.com/handsfreelink, or call (888) 528-7876.

In Canada, visit www.handsfreelink.ca, or call (888) 528-7876.

Using HFL Interface Dial

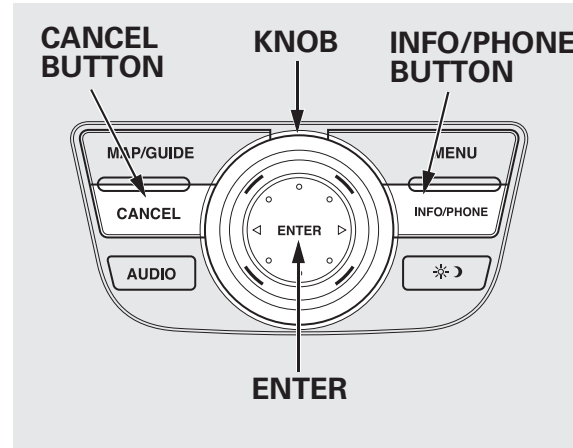

Use the Interface Dial to make menu or list selections.

To select an item on the screen, turn the selector knob left or right to highlight it, and then press ENTER.

To select an item that comes with ▲, ▼, ◀, or ▶ icons, push the knob up, down, left, or right.

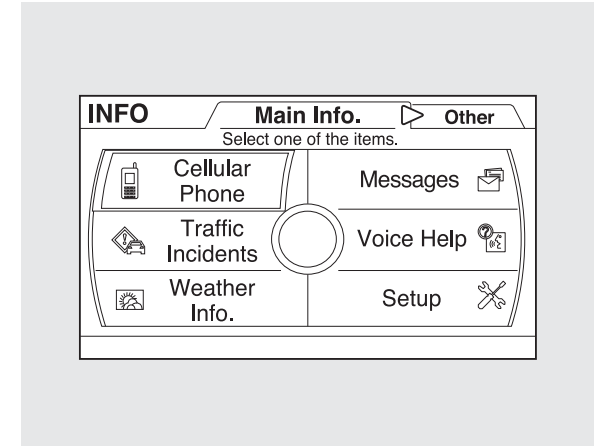

Press the INFO/PHONE button to go to the main information screen.

Press the CANCEL button to go back to previous screen.

CONTINUED

Bluetooth® HandsFreeLink® (Models with navigation system)

HFL Buttons

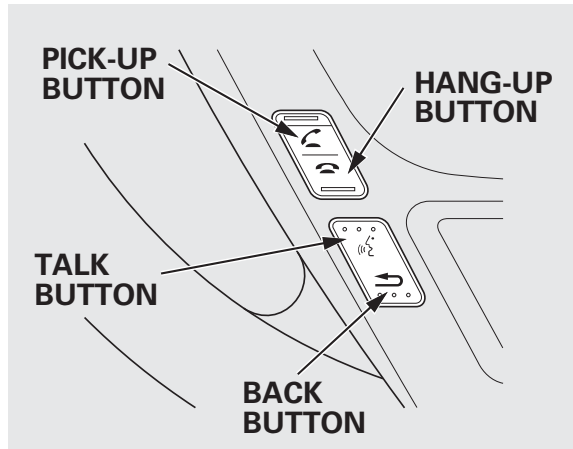

PICK-UP Button – Press and release to answer a call, or press to go directly to the Cellular Phone screen.

HANG-UP Button – Press and release to end or decline a call.

TALK Button – Press and release to give a command.

BACK Button – Press and release to go back to the previous command, or cancel the command.

Voice Control Tips

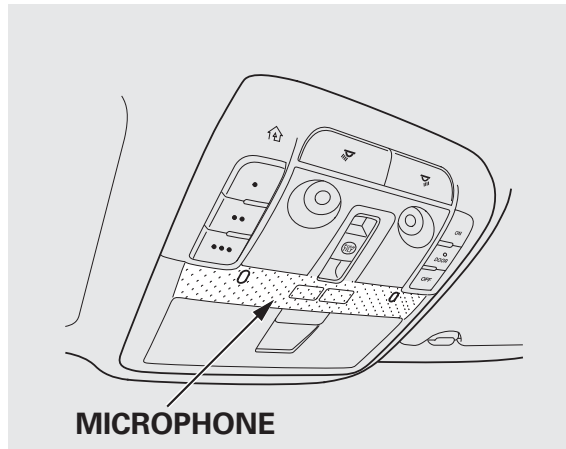

- Air or wind noise from the dashboard and side vents, and all windows may interfere with the microphone. Adjust or close them as necessary.
- Press and release the Talk button each time you want to make a command. After the beep, speak in a clear, natural tone.

- Try to reduce all background noise. If the microphone picks up voices other than yours, commands may be misinterpreted.
- To change the volume level of HFL, use the audio system volume knob or the steering wheel volume controls.

Help Feature

For help at any time, including a list of available options, say “Help.”

Language

Refer to the navigation system manual for how to change the system's language between English, French, and Spanish.

Bluetooth® HandsFreeLink® (Models with navigation system)

Displays

When you receive an incoming call, you will see the following displays and notifications.

On the audio screen:

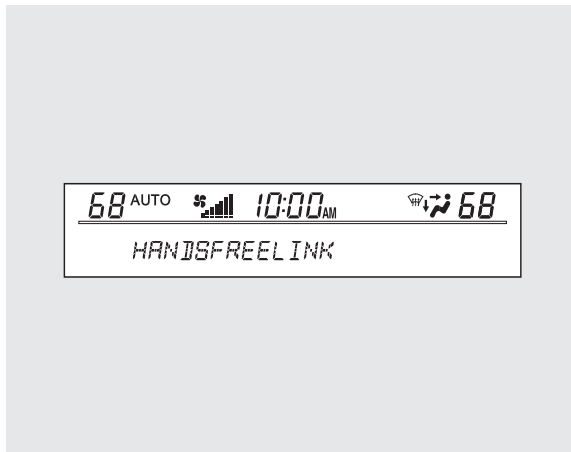

You will see “HANDSFREELINK” on the audio display while HFL is in use.

On the navigation screen:

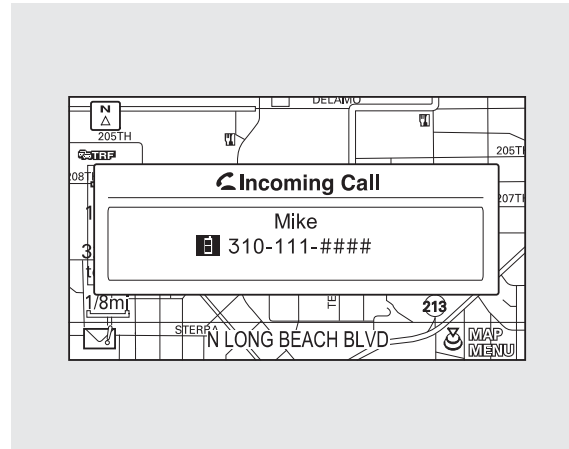

On the Cellular Phone screen:

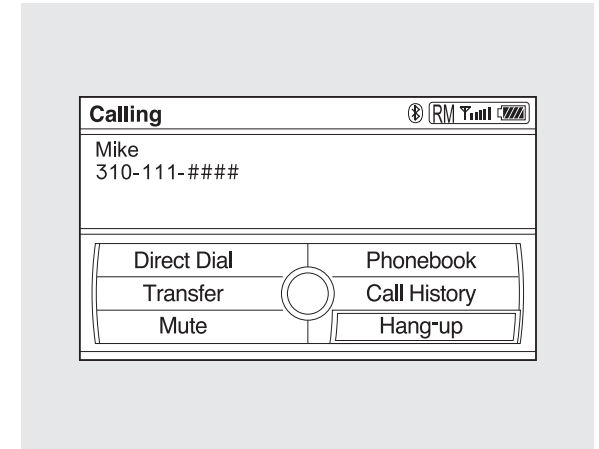

Some phones may send battery, signal strength, and roaming status information to the screen.

CONTINUED

Bluetooth® HandsFreeLink® (Models with navigation system)

How to Use HFL

- *The ignition switch must be in the ACCESSORY (I) or ON (II) position.*

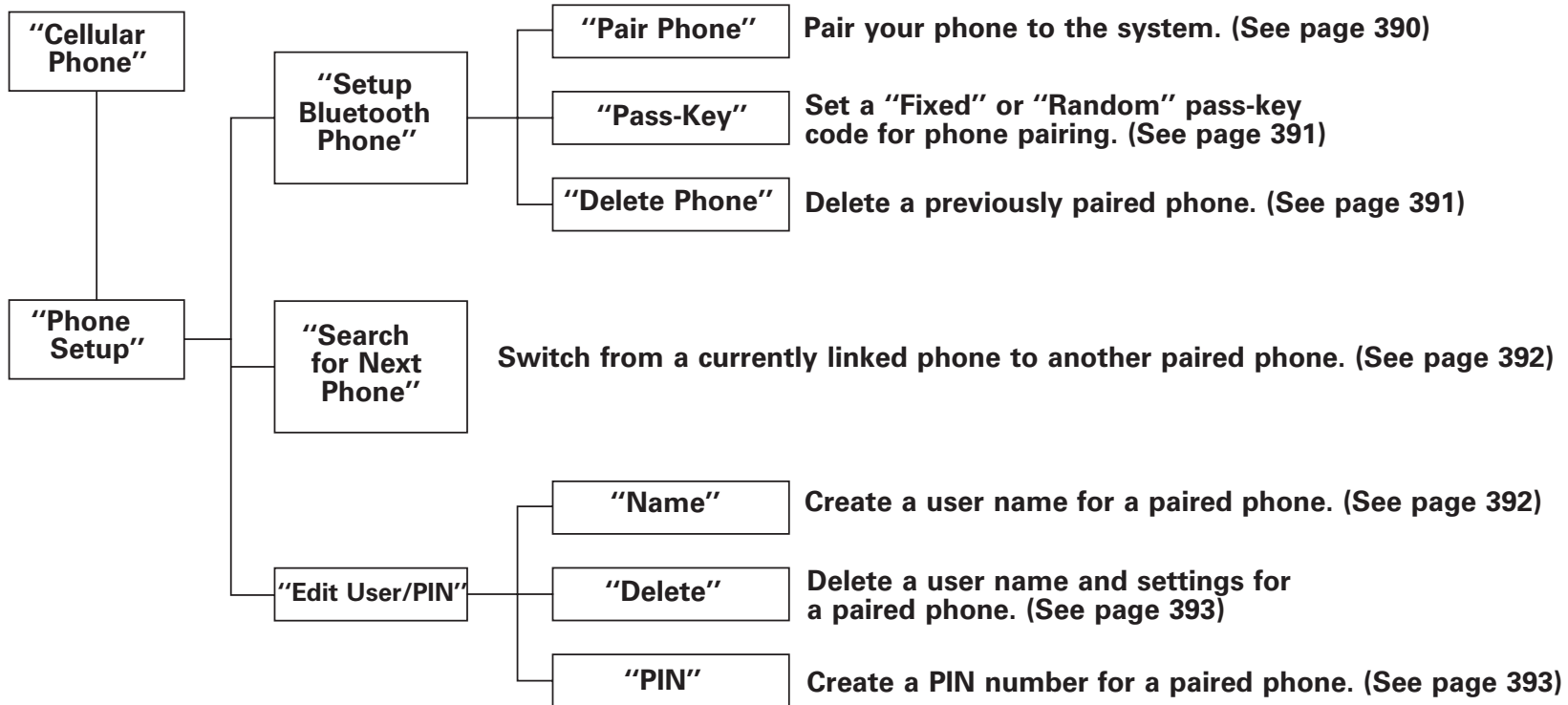

Voice commands can be used for all above options. Voice commands for the HFL system can only be used from the Cellular Phone screen. To quickly access the Cellular Phone screen, press the Pick-Up button on the steering wheel. Press and release the Talk button each time you give a command.

Bluetooth® HandsFreeLink® (Models with navigation system)

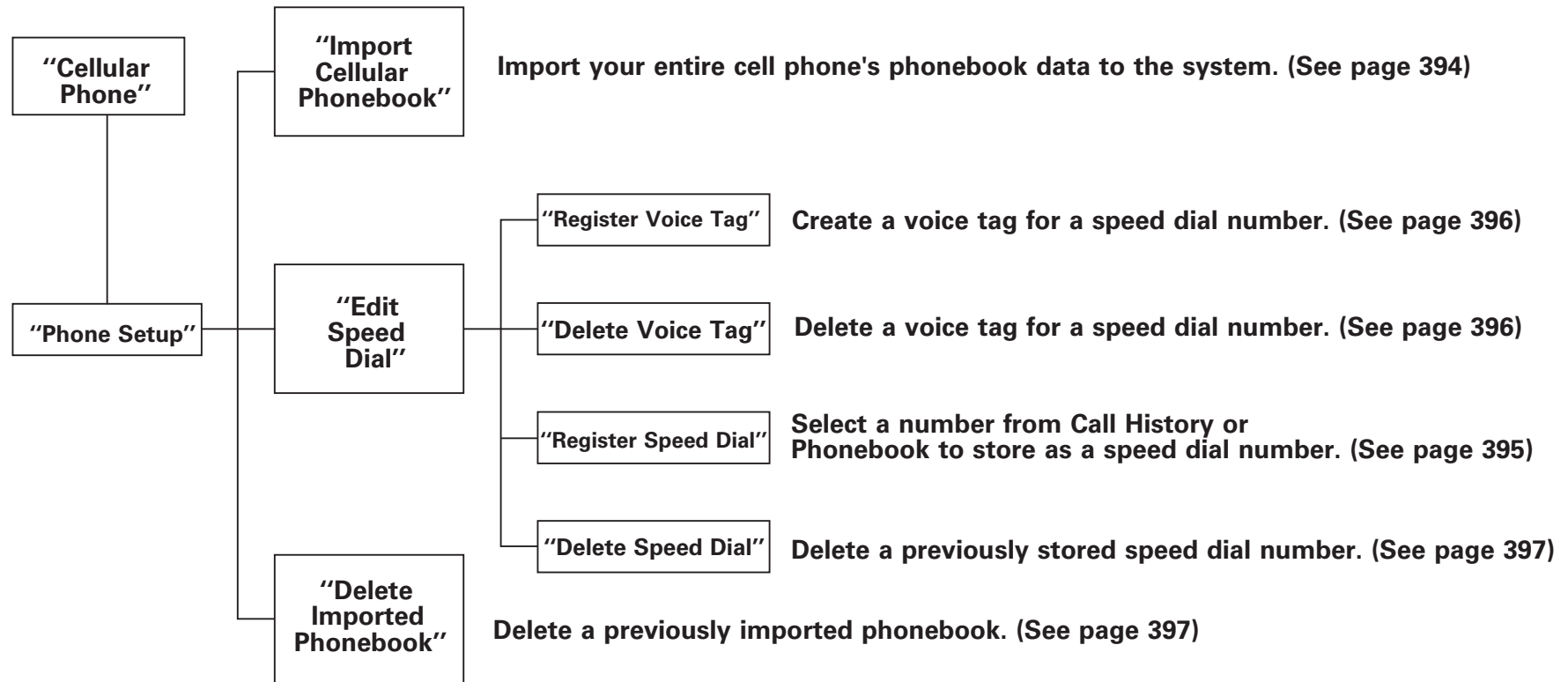

Voice commands can be used for all above options. Voice commands for the HFL system can only be used from the Cellular Phone screen. To quickly access the Cellular Phone screen, press the Pick-Up button on the steering wheel. Press and release the Talk button each time you give a command.

CONTINUED

Bluetooth® HandsFreeLink® (Models with navigation system)

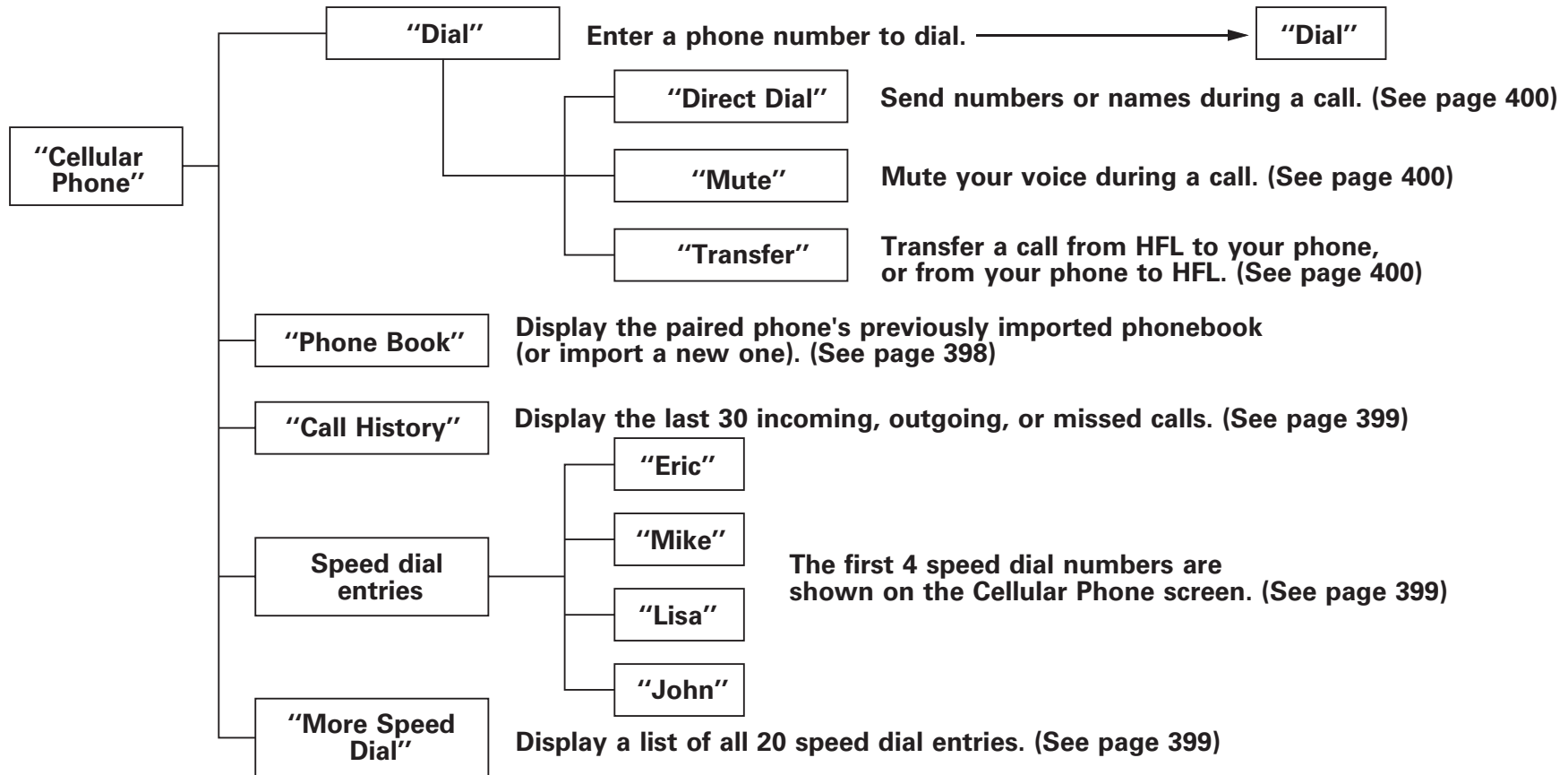

Voice commands can be used for all above options. Voice commands for the HFL system can only be used from the Cellular Phone screen. To quickly access the Cellular Phone screen, press the Pick-Up button on the steering wheel. Press and release the Talk button each time you give a command.

Bluetooth® HandsFreeLink® (Models with navigation system)

To use HFL, you need to pair your Bluetooth-compatible cell phone to the system.

HFL uses a Class 2 Bluetooth, which means the maximum range between your phone and vehicle is 30 feet (10 meters).

Cellular Phone

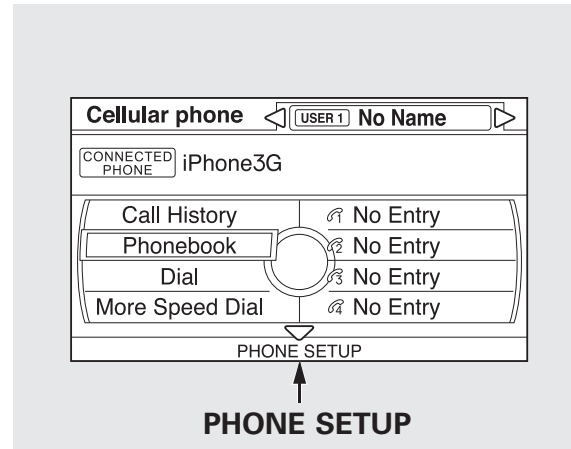

Press the PICK-UP button to go directly to the Cellular Phone screen.

Phone Setup

This menu group is for phone pairing, and user, phonebook, and speed dial editing.

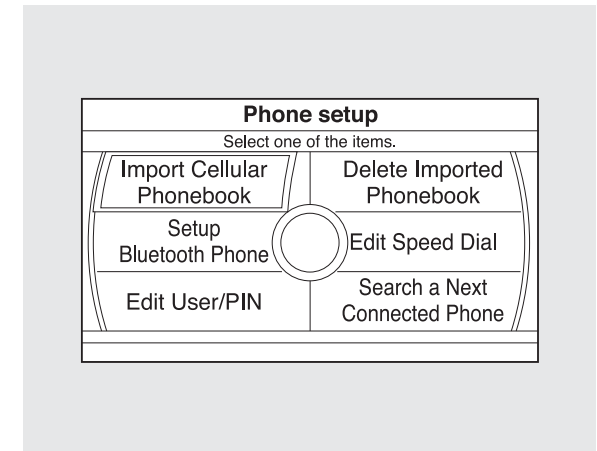

Select "PHONE SETUP" from the Cellular Phone screen.

CONTINUED

Bluetooth® HandsFreeLink® (Models with navigation system)

Setup Bluetooth Phone

To pair a cell phone:

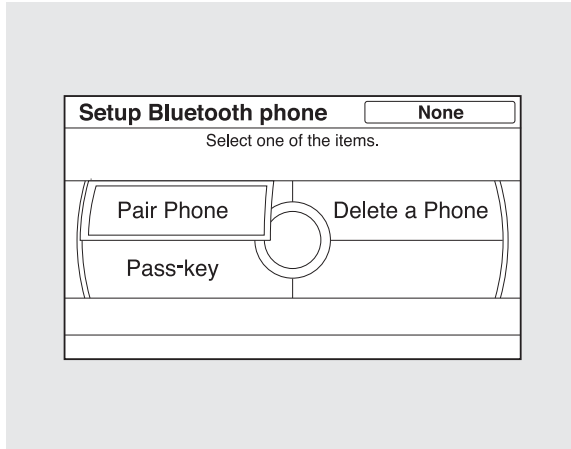

1. Select “Setup Bluetooth Phone” from the Phone Setup screen.
2. Select “Pair Phone.”
3. HFL gives you a 4-digit pass-key that you will need to input on your phone.

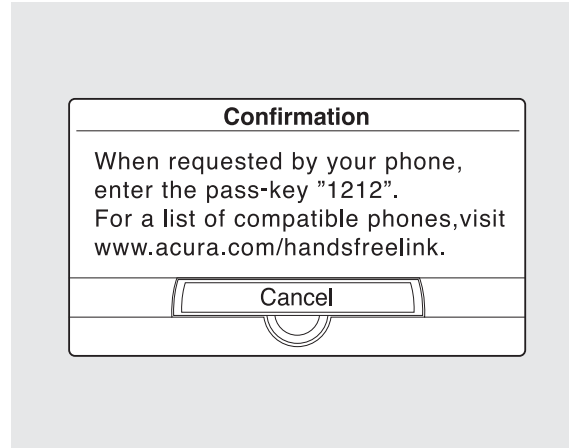

4. Put your cell phone in “Discovery” or “Search” mode, and search for a Bluetooth device.
5. When your phone prompts you, input the 4-digit pass-key.
6. You will receive a notification on the screen and your phone if pairing is successful.

Phone pairing tips:

- You cannot pair your phone while the vehicle is moving.
- Up to six phones can be paired.
- Your phone's battery may drain faster when it is paired to HFL.

Bluetooth® HandsFreeLink® (Models with navigation system)

To change the pass-key setting:

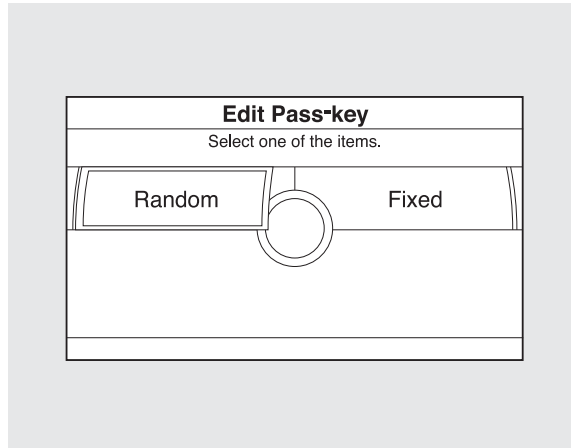

1. Select “Setup Bluetooth Phone” from the Phone Setup screen.
2. Select “Pass-Key.”

NOTE: The default pass-key “0000” is used until you change the setting.

For a randomly generated pass-key each time you pair a phone, select “Random.”

Delete the number first

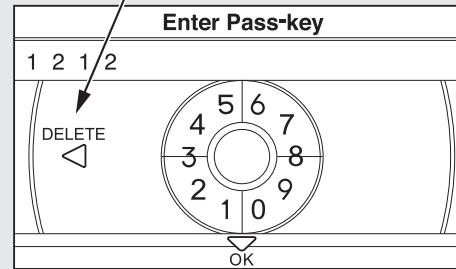

- To create your own pass-key, select “Fixed” and follow steps 3 and 4.
3. Delete the current pass-key.
 4. Enter a new pass-key, and select “OK.”

To delete a paired phone:

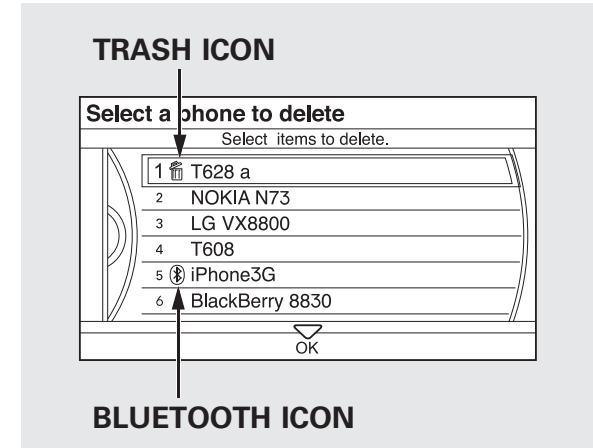

1. Select “Setup Bluetooth Phone” from the Phone Setup screen.
2. Select “Delete a phone.”
3. Select the phone you want to delete. The Bluetooth icon shows you the currently linked phone.
4. A trash icon appears next to the selected phone. Select “OK” to continue.

CONTINUED

Bluetooth® HandsFreeLink® (Models with navigation system)

Search for Next Connected Phone

To change from the currently linked phone to another paired phone, select “Search a Next Connected Phone” on the Phone Setup screen.

HFL disconnects the linked phone and starts searching for another paired phone.

If no other paired phone is found, HFL will automatically link the previous phone.

Edit User/PIN

You can name up to six HFL users. Each can be PIN protected, and have its own phonebook, speed dial, and call history.

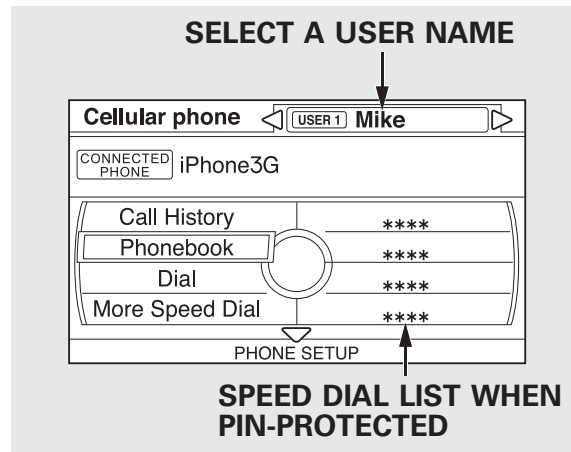

Select the user you want to edit on the Cellular Phone screen.

If the user you selected is PIN-protected, the speed dial list becomes “****.”

To name a user:

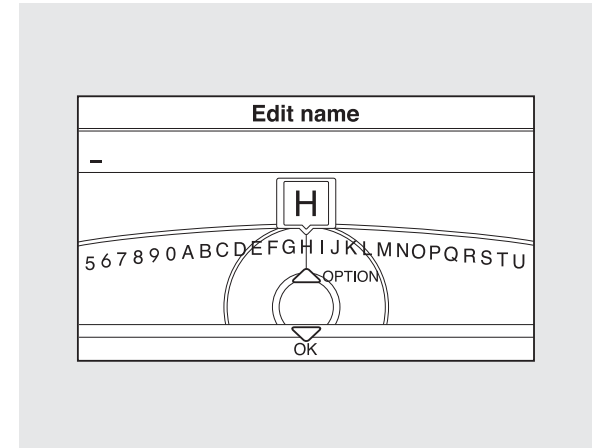

1. Select “Edit User/PIN” from the Phone Setup screen.
2. Select “Name.”
3. Enter a user name, and select “OK” when complete.

Bluetooth® HandsFreeLink® (Models with navigation system)

To create a PIN for each user:

When you set a PIN for a user, you will be asked to enter the PIN every time you select the user on the Cellular Phone screen.

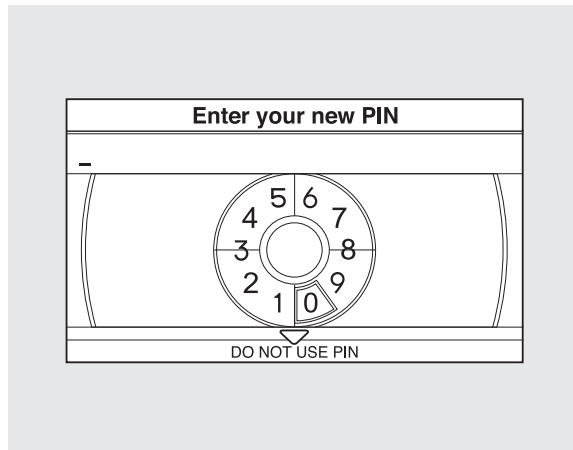

1. Select "Edit User/PIN" from the Phone Setup screen.
2. Select "PIN."

3. Enter a 4-digit PIN, re-enter it, and select "OK."

If you select "DO NOT USE PIN" before entering any number, the user will not have a PIN.

If the user is already PIN-protected, you need to enter the current PIN before creating a new one.

To delete a user:

Deleting a user will delete all settings, such as call history and phonebook.

1. Select "Edit User/PIN" from the Phone Setup screen.
2. Select "Delete."
3. Follow the prompts to complete the deletion.

CONTINUED

Bluetooth® HandsFreeLink® (Models with navigation system)

Import Cellular Phonebook (available on some phones)

The entire phonebook data (up to 1,000 entries, depending on the phone) of the cell phone that is linked to HFL can be imported to the system.

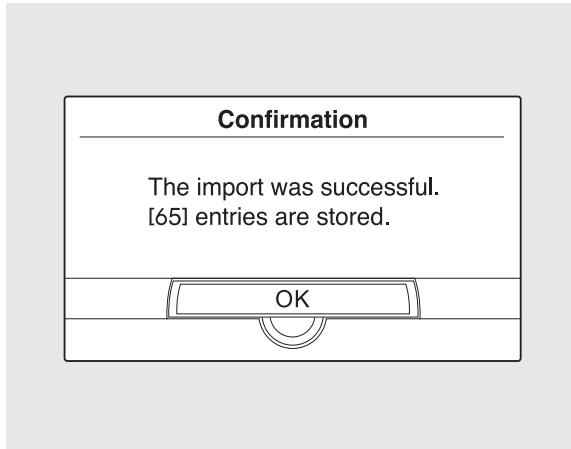

1. Select "Import Cellular Phonebook" from the Phone Setup screen.

2. HFL begins importing the phonebook. Select "OK" after the import is completed.

Up to three category icons appear next to the phonebook entries*.

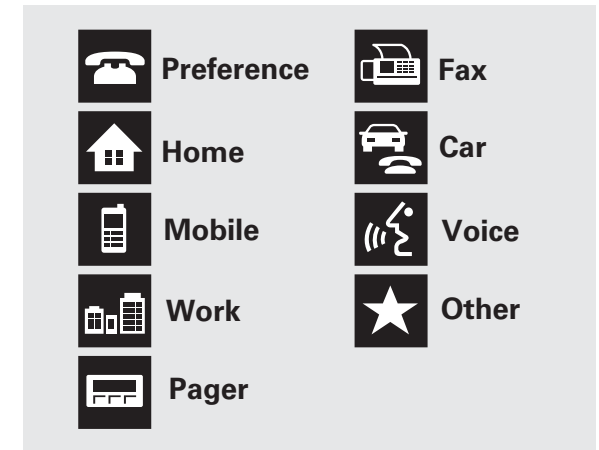

These indicate how many numbers are stored for the name. If a name has more than three category icons, "..." is displayed.

*Available on some phones

Edit Speed Dial

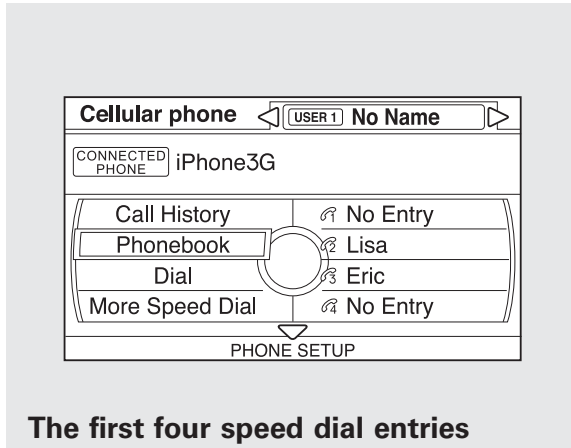

The first four speed dial entries

Up to 20 speed dial numbers can be stored per user, and the first four numbers are displayed on the Cellular Phone screen.

Select a “No Entry” field to store a speed dial entry, or use the following procedure.

To store a speed dial number:

1. Select “Edit Speed Dial” from the Phone Setup screen.
2. Select “Register Speed Dial.”
3. Select a number on the speed dial list where you want to store the number.

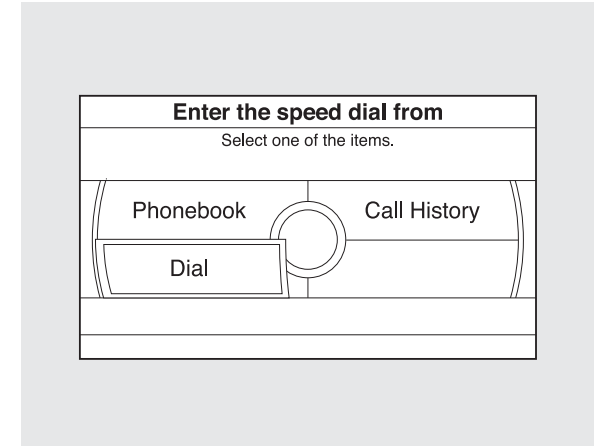

4. Choose a number from:

Phonebook – the linked cell phone's imported phonebook

Call History – the last 30 numbers

Dial – manual number input

5. When the speed dial number is successfully stored, you are asked to store a voice tag for the number. Follow the prompts.

CONTINUED

Bluetooth® HandsFreeLink® (Models with navigation system)

When a voice tag is stored for the entry, you can dial the number by saying “Call” and the voice tag name.

To add a voice tag to a stored speed dial number:

1. Select “Edit Speed Dial” from the Phone Setup screen.
2. Select “Register Voice Tag.”
3. Select the number you want to store a voice tag for.

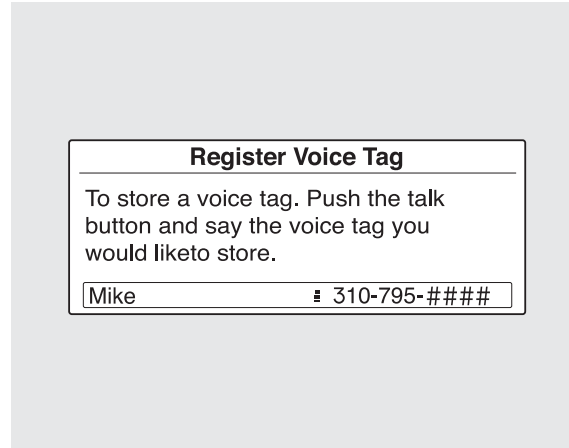

1. Follow the prompts to complete the voice tag.

NOTE:

- Avoid using duplicate voice tags.
- Avoid using “home” as a voice tag.
- It is easier for HFL to recognize a longer name. For example, use “John Smith” instead of “John.”

To delete a voice tag:

1. Select “Edit Speed Dial” from the Phone Setup screen.
2. Select “Delete Voice Tag.”
3. Select the number you want to delete the voice tag for, and select “OK.”

Bluetooth® HandsFreeLink® (Models with navigation system)

To delete a speed dial number:

1. Select “Edit Speed Dial” from the Phone Setup screen.
2. Select “Delete Speed Dial.”
3. Select the number you want to delete, and select “OK.”

Delete Imported Phonebook

This option deletes the entire phonebook of the currently linked cell phone. Follow the confirmation and notification screens.

Making a Call

You can make calls by inputting any phone number, using the imported phonebook, using the call history, or with speed dial entries.

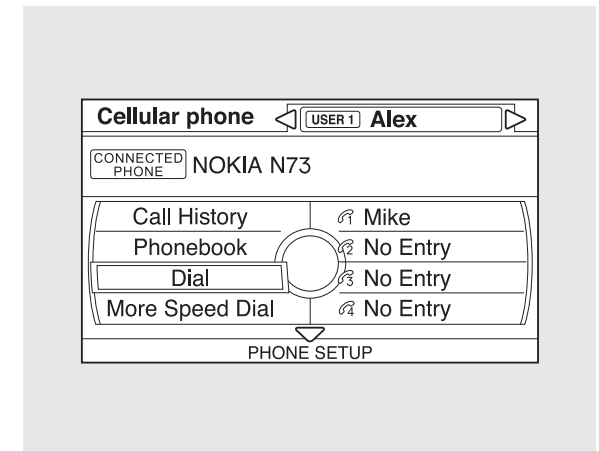

During a call, HFL allows you to talk up to 30 minutes after you remove the key from the ignition switch. However, this may weaken the vehicle's battery.

CONTINUED

Bluetooth® HandsFreeLink® (Models with navigation system)

To make a call using a name in the Phone Book:

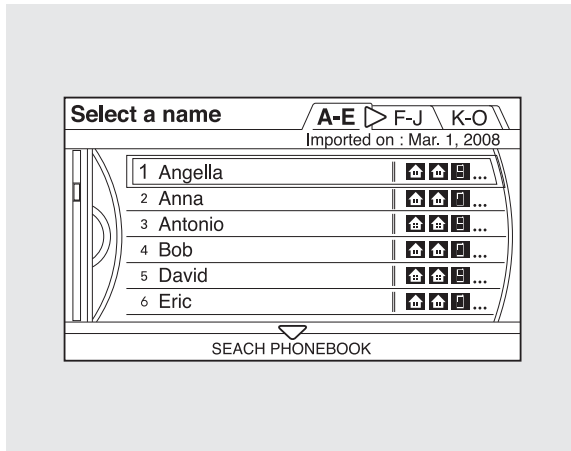

1. Select “Phonebook” from the Cellular Phone screen.

If a phonebook has not yet been imported, the system will attempt to import one first.

2. Select a name from the list. You can also select “Search Phonebook” and enter the first few letters of the name.
3. Push ENTER to begin automatic dialing.

To make a call using a phone number:

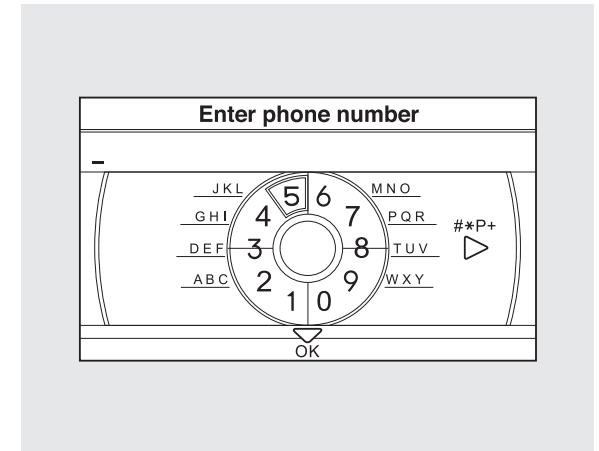

1. Select “Dial” from the Cellular Phone screen.
2. Enter the phone number, and select “Dial.”

To enter the phone number by voice, say it in a continuous string.

Bluetooth® HandsFreeLink® (Models with navigation system)

To make a call using Call History:

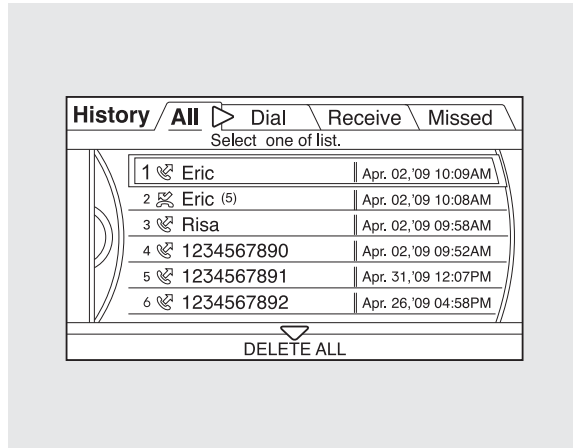

1. Select “Call History” from the Cellular Phone screen.
2. Call History is sorted by “All,” “Dial,” “Receive,” and “Missed.” Selecting a number to begin automatic dialing.

To make a call using Speed Dial:

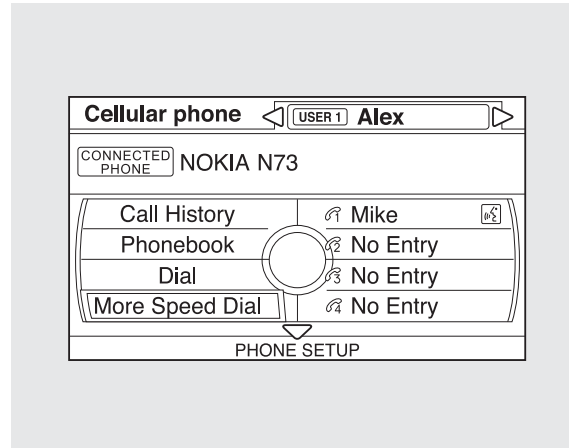

Select one of the four entries on the Cellular Phone screen, and push ENTER to begin automatic dialing.

To make a call using More Speed Dial:

1. Select “More Speed Dial” on the Cellular Phone screen.
2. A list of up to 20 stored speed dial entries is shown. Select the entry you want to call, and push ENTER to begin automatic dialing.

NOTE: Any voice-tagged speed dial entry can be dialed by voice from the Cellular Phone screen.

CONTINUED

Bluetooth® HandsFreeLink® (Models with navigation system)

Receiving a Call

When you receive a call, a notification appears on the screen. (see page 385).

To answer the call, press the PICK-UP button on the steering wheel.

To end or decline the call, press the HANG-UP button.

During a Call

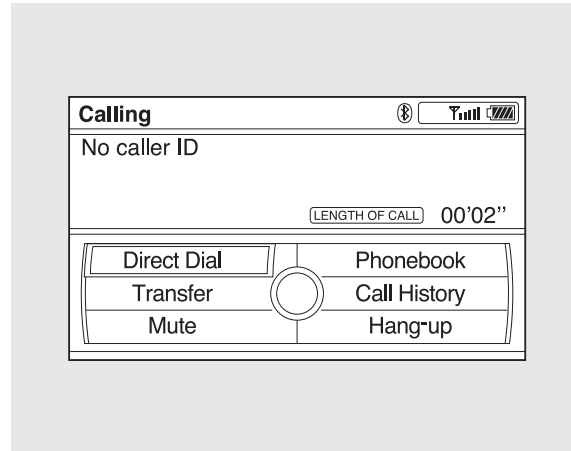

The following options are available during a call:

Direct Dial* – Allows you to send numbers or names during a call. This is useful when you call a menu-driven phone system.

Transfer – Allows you to transfer a call from HFL to your phone, or from your phone to HFL.

Mute – Allows you to mute your voice.

*Available on some phones

Bluetooth® HandsFreeLink® (Models with navigation system)

Call Waiting

If your phone has Call Waiting, press and release the PICK-UP button to put the original call on hold and answer the incoming call.

To return to the original call, press the PICK-UP button again. If you don't want to answer the incoming call, disregard it and continue with your original call. If you want to hang up the original call and answer the new call, press the HANG-UP button.

Bluetooth® Wireless Technology

The *Bluetooth®* name and logos are registered trademarks owned by Bluetooth SIG, Inc., and any use of such marks by Honda Motor Co., Ltd., is under license. Other trademarks and trade names are those of their respective owners.

As required by the FCC:

This device complies with Part 15 of the FCC rules. Operation is subject to the following two conditions: (1) This device may not cause harmful interference, and (2) this device must accept any interference received, including interference that may cause undesired operation.

Changes or modifications not expressly approved by the party responsible for compliance could void the user's authority to operate the equipment.

This device complies with Industry Canada Standard RSS-210.

Operation is subject to the following two conditions: (1) this device may not cause interference, and (2) this device must accept any interference that may cause undesired operation of the device.

AcuraLink® (U.S. models only)

AcuraLink® (U.S. models only)

On models with navigation system
AcuraLink enhances your ownership experience by providing a direct communication link between your vehicle and the Acura Server. Working through the XM radio satellite, AcuraLink works in conjunction with the navigation system, *Bluetooth*® HandsFreeLink® (HFL), and audio system in your vehicle. It displays and receives several kinds of messages, including:

- Operating tips and information on your vehicle's features.
- Important recall and safety information.
- Maintenance information to keep your vehicle in top condition.
- Diagnostic information to provide information about any problems with your vehicle.

Interface Dial

Most AcuraLink functions are controlled by the interface dial. The interface dial has two parts, a knob and a selector.

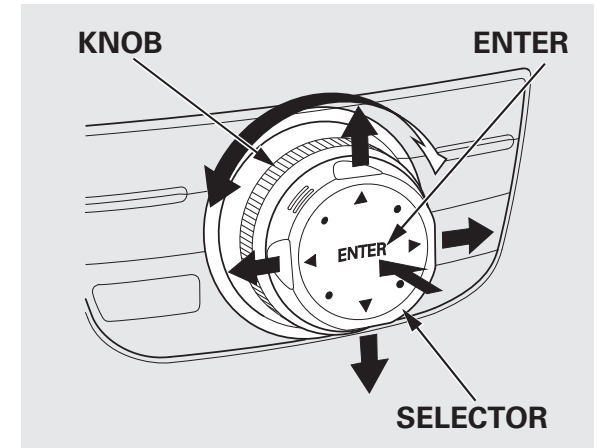

The knob turns left and right. Use it to make selections or adjustments to a list or menu on the screen.

The selector can be pushed left, right, up, down, and in. Use the selector to scroll through lists, to select menus, and to highlight menu items. When you make a selection, push the center of the selector (ENTER) to go to that selection.

Reading Messages

If you have new messages, an envelope icon appears in the lower left hand part of the navigation screen.

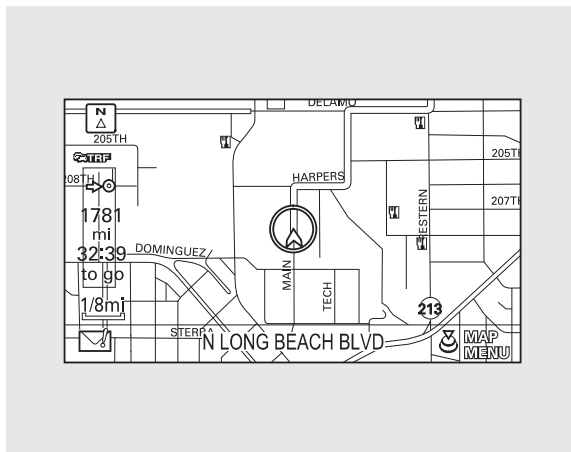

To open a message:
Press ENTER on the interface selector, then select New Message from the navigation system map menu.

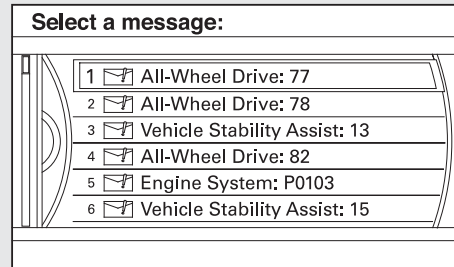

A list of all messages will be shown. New Messages will be at the top. Select the message you want to read by pressing ENTER.

To view previously read messages:

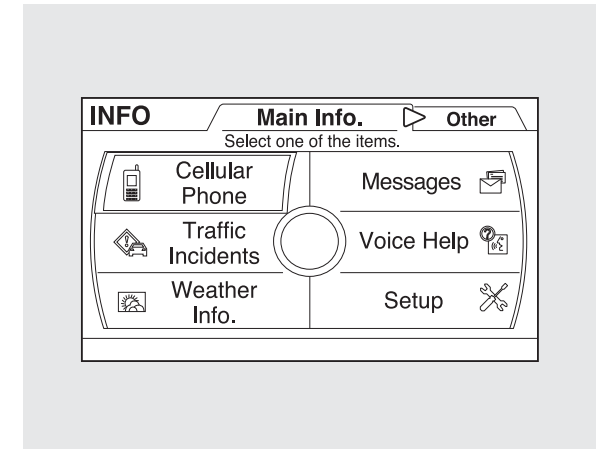

Press the INFO button. The information screen will be shown.

CONTINUED

AcuraLink® (U.S. models only)

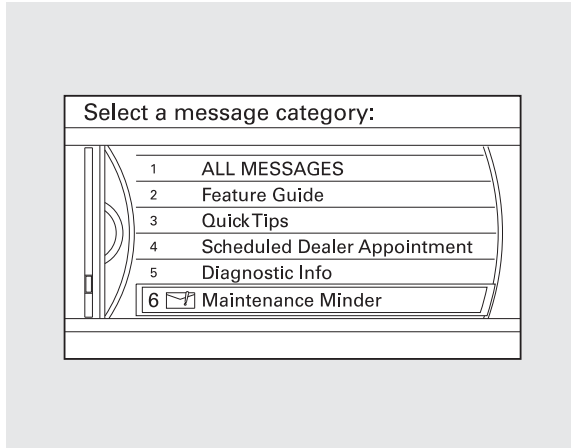

Select "Messages", then select a message category by pressing ENTER. Select the message you want to read and press ENTER.

Unread messages have a closed envelope icon next to them. The icon disappears when it has already been read.

NOTE: Only Diagnostic Info messages overlay the navigation screen while driving. They indicate if your vehicle has a problem that may need immediate attention (see page 413).

After purchasing your vehicle, messages may not appear immediately.

Your dealer has to register the vehicle identification before you can receive messages. This can take several days to process.

Message Options

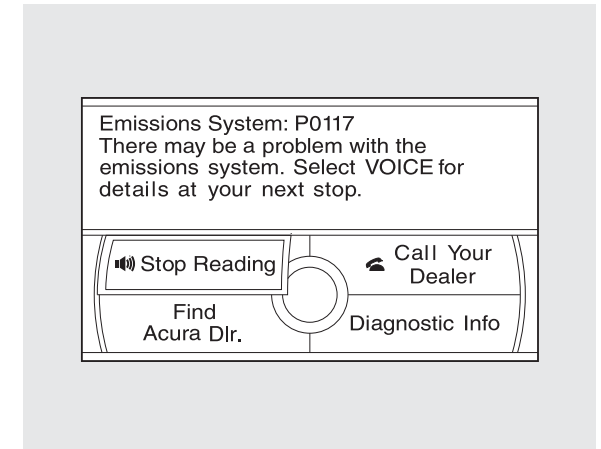

When you open a message, you can read a summary of it, and then choose one of several options. If an option is not available for a message, that button will not be highlighted.

Delete – Select this option to delete the current message.

Voice – Select this option to hear a voice read the entire message. This gives you more information than the screen can display at one time. When you select the Voice option, it changes to a Stop Reading option. Select the option again to stop the voice.

Call – Select this option to call a phone number embedded in the message. When you select **Call**, the *Bluetooth*® HandsFreeLink® (HFL) dials the number for you.

To make a call, your *Bluetooth*® compatible phone must be paired to the vehicle's HandsFreeLink system, powered on, and located within the vehicle (see page 383).

Find Acura Dlr. – Select this option to find the nearest Acura dealer using the navigation system.

Call Your Dealer – Select this option to call the Acura dealer you purchased your vehicle from. AcuraLink also directs you to this dealer so you can schedule a maintenance appointment or receive information about a message. If your assigned servicing dealer changes, AcuraLink will reset to call that dealer.

Diagnostic Info – Select this option to get more information about the current diagnostic message. To use this option, your cellphone must be paired with the HFL. In addition, the paired phone must have a compatible data service and be set up with the AcuraLink system to make a data connection. Access the handsfreelink.com website to find out which data services are currently compatible with AcuraLink.

Message Preferences

To set your AcuraLink preferences (the types of messages you want to receive, if any), visit the My Acura website at www.owners.acura.com, and choose what you would like to receive. If you do not have internet access, call Acura Client Relations at (800) 382-2238; they can set your message preferences for you.

CONTINUED

AcuraLink® (U.S. models only)

Deleting Messages

NOTE: Diagnostic info and recall/campaign messages can only be deleted by your dealer.

To delete a single message:

- Press the INFO button to bring up the Information screen.
- Scroll to the Messages option, then select it by pressing ENTER on the interface selector.
- Select the message category that contains the message you want to delete.
- Use the interface knob to scroll up or down to the message title you want to delete, and select it by pressing ENTER on the interface selector.
- Scroll to Delete with the interface knob, and select it by pressing ENTER on the interface selector.

To delete all messages:

NOTE: The Delete All Messages command does not apply to Diagnostic Info and Recall messages. They can only be deleted by your dealer.

- Press the SETUP button to view the setup screen.
- Select Other by pushing the interface selector to the right.

- Use the interface knob to scroll to the AcuraLink/Messages option, and select it by pressing ENTER on the interface selector.
- Scroll to the Delete Messages option, and select it by pressing ENTER on the interface selector.
- Scroll to the category with the messages you want to delete, and select the category by pressing ENTER on the interface selector.

Message Categories

There are six message categories in AcuraLink: Quick Tips, Feature Guide, Maintenance Minder™, Recalls/Campaigns, Diagnostic Info, and Scheduled Dealer Appointments. The system can store up to 255 messages.

Message categories can be added, revised, or deleted through broadcast messages from Acura.

Quick Tips

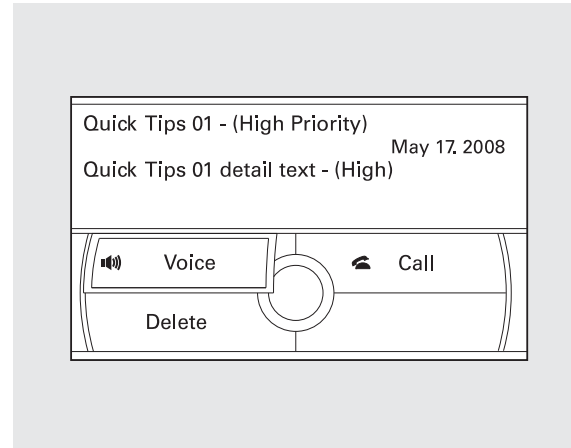

These messages, based on updated vehicle information and comments from other MDX owners, supplement your Owner's Manual. They provide you with relevant information for a safe and enjoyable ownership experience. For additional information, call Acura Client Relations directly through the HFL.

Feature Guide

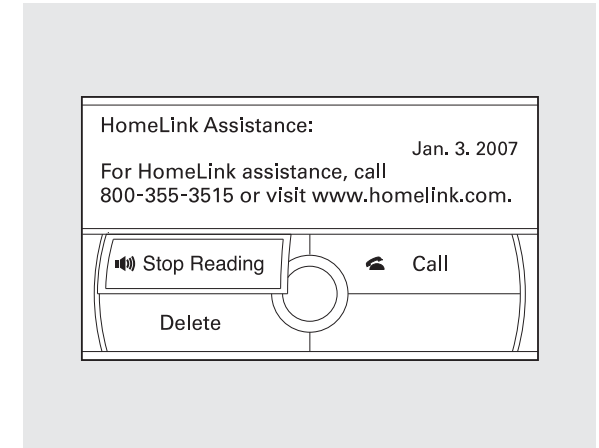

During the first 90 days of ownership, a number of messages appears each day. These messages help you to use and understand the features of your vehicle.

CONTINUED

AcuraLink® (U.S. models only)

Maintenance Minder™

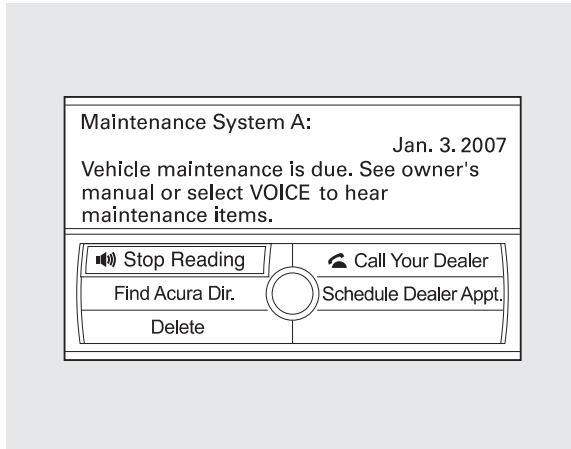

These messages provide detailed information about the service needed for your vehicle. When a maintenance message appears on the multi-information display, a list of needed maintenance items is provided through an AcuraLink message. These messages tell you the exact maintenance needed, helping you to avoid unnecessary maintenance costs.

You can use the following message options:

- Make an appointment from the schedule at the dealer.
- Reschedule the appointment with the dealer.
- Call your dealer for an appointment.
- Find the nearest dealer.

Automated Appointment

You can make an appointment with your dealer through AcuraLink when you receive a Maintenance Minder message.

To use the automated appointment function, you should visit the My Acura website at www.owners.acura.com, register some required settings, and complete the Phone-Data Connection set-up (see page 416). Your *Bluetooth*® compatible phone should also be paired and linked to your vehicle's *Bluetooth*® HFL (see page 389).

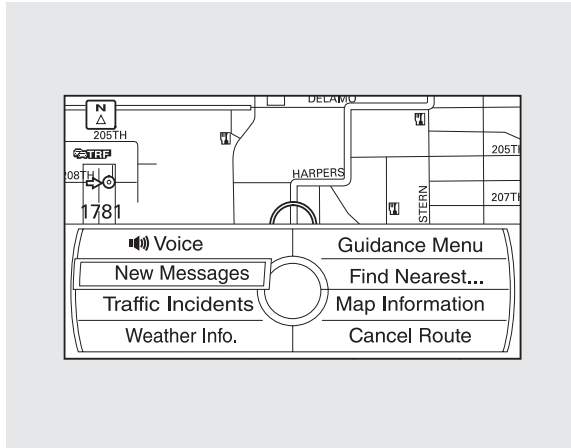

When you see the Maintenance Minder message on the multi-information display, you will also receive a message in the navigation screen. To open the message, press ENTER. Select “New Messages,” then press ENTER. You will see the list of all messages. The most recent message is listed at the top.

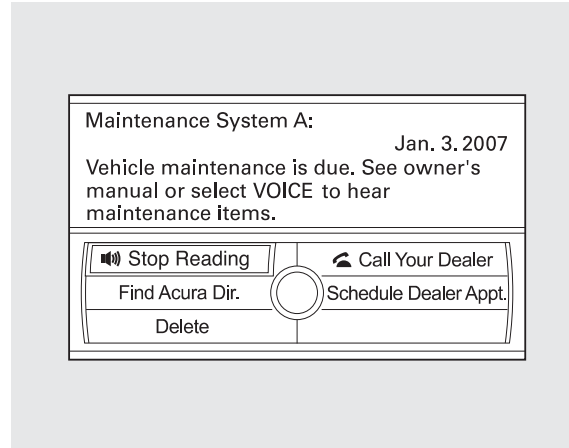

Select the received message, then press ENTER. You will see the message as shown. To make an appointment, select “Schedule Dealer Appt.” then press ENTER.

The system will automatically connect to the Acura server, then show you an appropriate appointment date and time on the navigation screen. If you accept this appointment, select “Confirm Appointment,” then press ENTER.

CONTINUED

AcuraLink® (U.S. models only)

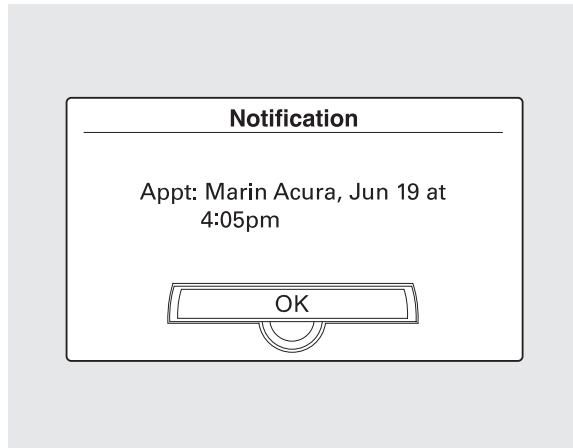

The confirmation message will be displayed on the screen. Make sure to confirm the appointment date, time and dealer. If it is OK, press ENTER.

If you want to change or reschedule the appointment date, select "Cancel," then press ENTER.

Scheduled Dealer Appointment *To reschedule the appointment:*

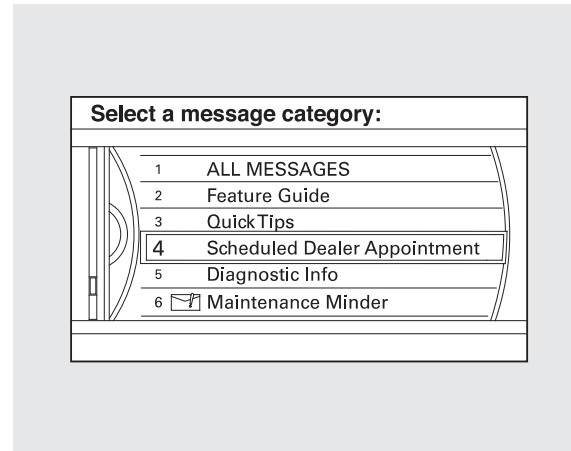

Press the INFO/PHONE button to go to the information screen. Select "Messages," then select "Scheduled Dealer Appointment" from the message category list. Then press ENTER.

You will see the screen to reschedule as shown. To make an appointment, select "Reschedule Appointment," then press ENTER.

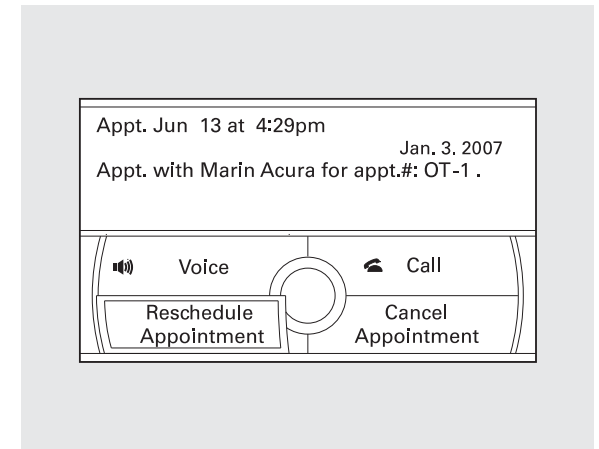

The system will automatically connect to the Acura server, then show you a new appointment date and time on the navigation screen. If you accept this appointment, select "Confirm Appointment," then press ENTER.

To cancel the appointment:

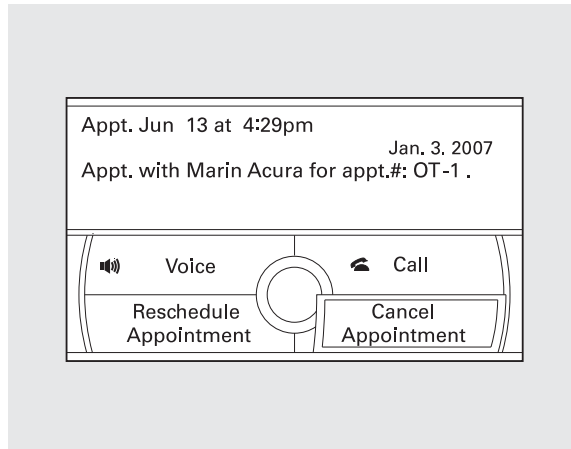

Press the INFO/PHONE button to go to the information screen. Select "Messages", then select "Scheduled Dealer Appointment" from the message category list. Then press ENTER. You will see the screen to cancel as shown. To cancel the appointment select "Cancel Appointment", then press ENTER.

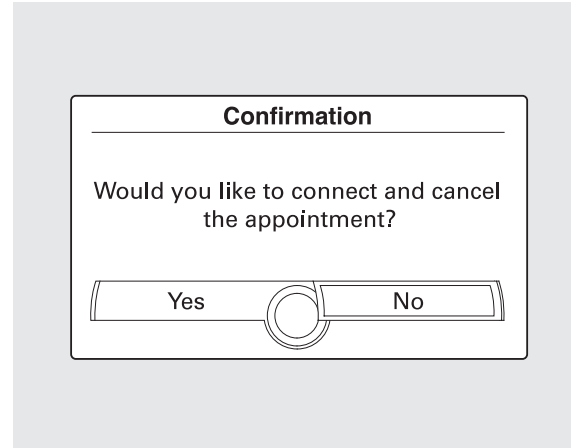

The system will request you to confirm the cancellation on the navigation screen. To cancel the appointment, select "YES," then press ENTER. If you select "NO," the screen goes back to the previous message display.

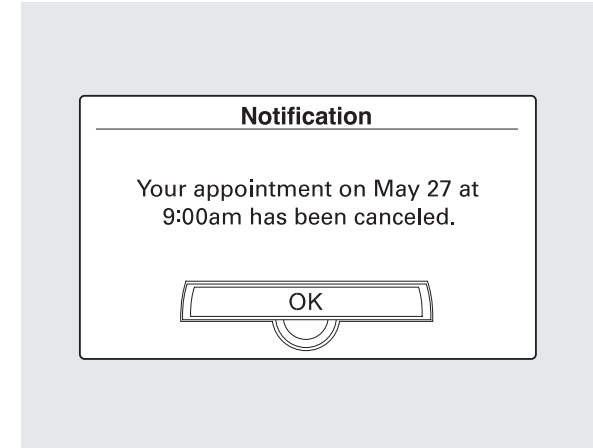

The system will automatically connect to the Acura server, then show you the confirmation on the navigation screen. If you accept the cancellation, press ENTER.

If you select the cancellation appointment, you cannot try to reschedule the appointment. If you want to change or reschedule the appointment date, call your dealer directly with the HFL.

CONTINUED

AcuraLink® (U.S. models only)

Using automated appointment, your registered dealer through My Acura is automatically selected. If you want to select another dealer, such as in case of an emergency, find the nearest dealer and call the dealer directly with the HFL.

When a maintenance appointment is due soon, you will also receive an appointment reminder message.

Recall/Campaigns

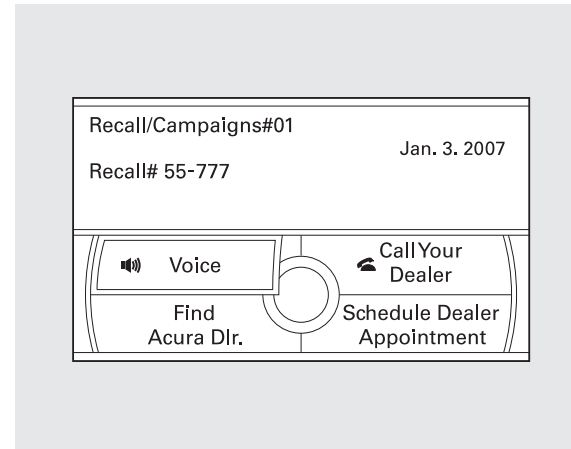

If your vehicle is affected by a recall or other important safety information, a letter will be mailed to you about the issue and how to fix it. If you don't get your vehicle fixed, you will also receive a reminder message through AcuraLink. You can then use the message options to call your dealer for an appointment or to find the nearest dealer.

For this reason, it is important that we retain your current phone number. Please update your information using My Acura at www.owners.acura.com.

Diagnostic Info

When an indicator comes on or a message is displayed on the Multi-Information Display (MID), AcuraLink can provide information about the cause of the indicator or message and the recommended action to address it. This helps you handle the problem as it occurs, preventing or limiting costly repairs.

The AcuraLink system cannot determine some mechanical problems (such as squeaks or rattles) that are not triggered by the diagnostic indicator monitors.

For more information on the instrument panel indicators, see page 68.

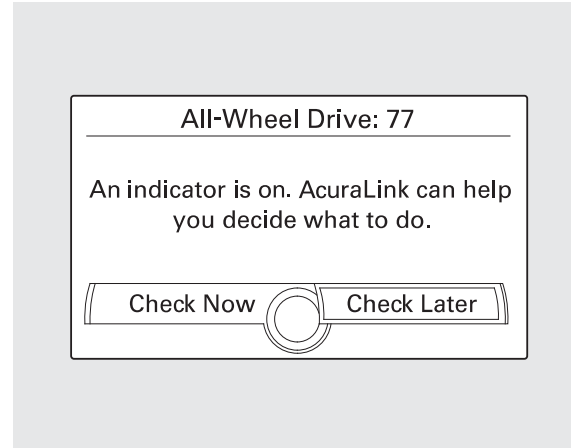

When any indicator comes on or a message is displayed on the MID, AcuraLink immediately notifies you with the message, “An indicator is on. AcuraLink can help you decide what to do.” If you do not want the information right away, select the Check Later option. If you want the information now, select the Check Now option. (If the navigation screen is not active, you must select OK from the navigation disclaimer screen before you can check the information.)

Depending on the severity of the problem, the message will let you know if you should see your dealer immediately or if you can wait until a later date.

You can then use the message options to call your dealer for an appointment or to find the nearest dealer.

CONTINUED

AcuraLink® (U.S. models only)

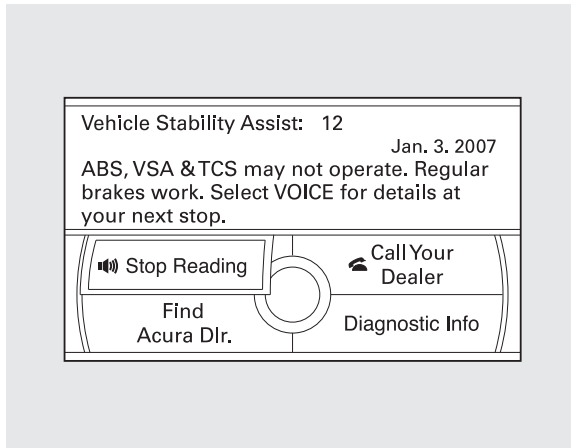

When viewing a diagnostic info message through the INFO menu, you can select the Diagnostic Info option to connect to the Acura server and retrieve the latest information regarding the problem.

NOTE: There may not be any additional information, depending on the time elapsed since the previous time you retrieved the information from the Acura server.

Reminder Message

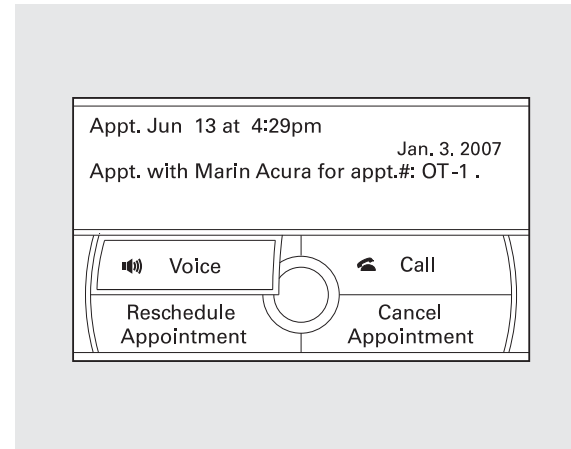

When you make an appointment through My Acura's online Scheduling Service Appointment, you can be reminded in advance about that appointment through AcuraLink.

If you need to reschedule or cancel the appointment, see page 410.

Turning the Automated Appointment preference off will disable appointment notifications in the vehicle based on appointments created or changed at My Acura's online scheduling website.

Appointments can still be created, rescheduled, and canceled from the vehicle; however, the appointment information stored in the vehicle will not be updated. Any changes to those appointments should be made from the My Acura website.

AcuraLink/Message Screen

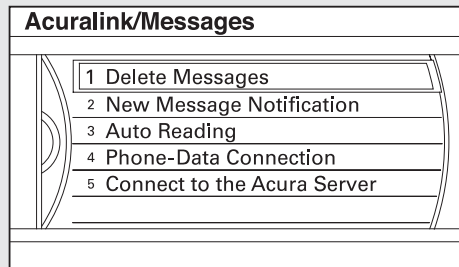
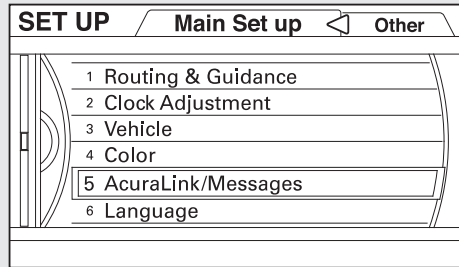

To access the following functions, press the INFO/PHONE button, then select the SETUP option, push the interface selector to the right to select Other, then rotate the interface knob to select AcuraLink/Messages.

Delete Messages – Select this option to delete all stored messages within a category, except for diagnostic info and recall campaign messages. These messages can only be deleted by a certified technician after the recall is done or the problem is corrected, or through a broadcast message from Acura.

New Message Notification – Select ON if you want to be notified of new messages (envelope icon appears on the navigation screen). Select OFF if you do not want to be notified of new messages (envelope icon does not appear on the screen). Messages can still be accessed using the INFO menu. If you would like to stop receiving messages, visit the My Acura website at www.owners.acura.com to change your messaging preferences.

Auto Reading – Select ON to have the system automatically read each message to you. Select OFF to manually select the Voice button when you want a message read to you.

CONTINUED

AcuraLink® (U.S. models only)

Phone-Data Connection – Select this option to begin the process required to connect to Acura. This is used to access the most recent diagnostic information when a problem occurs.

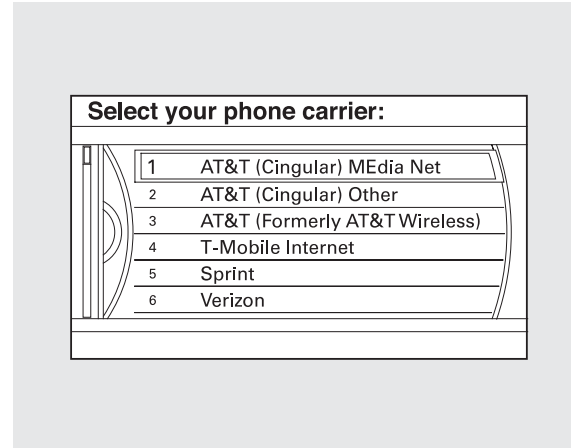
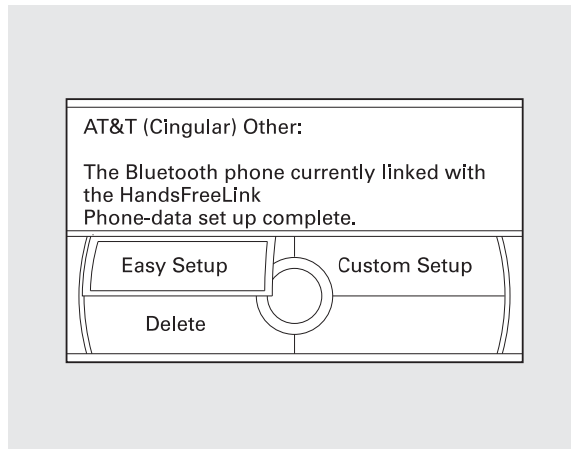

NOTE: For the Phone Data Connection button to be active, you need a *Bluetooth*® compatible and enabled cell phone paired to the *Bluetooth*® HandsFreeLink® (HFL). To complete the data connection setup, the paired phone must have a compatible data service.

To find more information on *Bluetooth*® compatible and enabled cell phones, visit www.acura.com/handsfreelink or call the HandsFreeLink® consumer support at 1-888-528-7876.

AcuraLink® (U.S. models only), Rearview Mirror with Rearview Camera Display

Connect to the Acura Server –

The default setting is prompt. When a diagnostic info message appears, and you select the Check Now option, the system will prompt you before connecting to the Acura server. If you do not wish to connect at that time, select No at the prompt, and you will see the information from the onboard database. The “Auto” setting will remove the prompt when you select the Check Now option and will automatically connect to the Acura server. This setting only applies when you have a *Bluetooth*® enabled phone that is paired with the HFL and you have completed the Phone-Data Connection setup.

As required by the FCC:

This device complies with Part 15 of the FCC rules. Operation is subject to the following two conditions: (1) This device may not cause harmful interference, and (2) this device must accept any interference received, including interference that may cause undesired operation.

Changes or modifications not expressly approved by the party responsible for compliance could void the user's authority to operate the equipment.

Rearview Mirror with Rearview Camera Display

On models with navigation system

Refer to the navigation system manual for operation of the rearview camera.

CONTINUED

Rearview Mirror with Rearview Camera Display

On models without navigation system

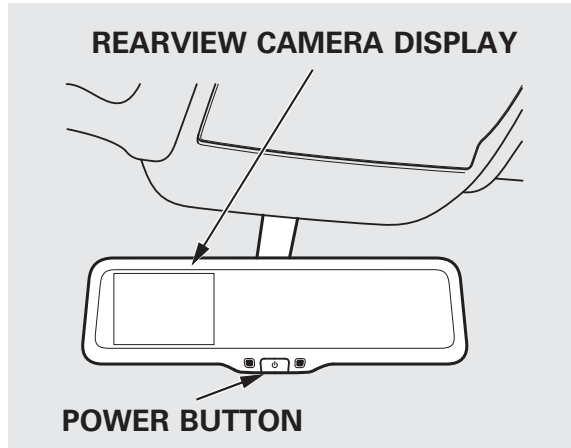

You can turn the camera display on and off by pressing the power button when the shift lever is in reverse. The camera display turns on everytime you shift to reverse, even if you turned it off the last time.

Whenever you shift to reverse (R) with the ignition switch in the ON (II) position, the rearview appears on a display in the rearview mirror.

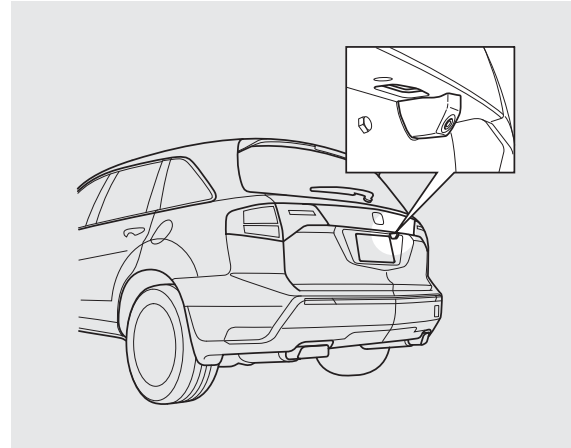

For the best picture, always keep the rearview camera clean, and do not cover the camera lens. To avoid scratching the lens when you clean it, use a moist, soft cloth.

Since the rearview camera display area is limited, you should always back up slowly and carefully, and look behind you for obstacles.

If the engine has just been started, it may take a short time for the system to display the rearview.

The camera display brightness is adjusted automatically by sensors. If you use the camera display continuously at high temperatures, the image will gradually dim.

The rearview mirror will be hot when you use the camera display for an extended period of time.

If a bright light (such as sunlight) is reflected on the mirror, the image may be difficult to see.

Rearview Mirror with Rearview Camera Display

Rearview Camera Guide Line

SCREEN DISPLAY

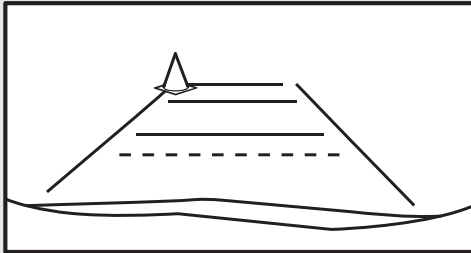

ACTUAL DISTANCE

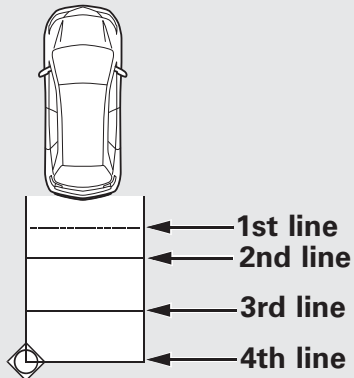

The camera display has parking guide lines that indicate distance from your vehicle.

1st Line	20in (0.5m)
2nd Line	39in (1m)
3rd Line	79in (2m)
4th Line	118in (3m)

NOTE

- The rearview camera has a unique lens that makes objects appear closer than they actually are.
- The rearview camera display has a limited coverage, and the size and position of objects may appear different than they actually are. Make sure to check the surrounding area carefully.

To turn off the guide lines, press and hold the power button for more than 3 seconds. The guide lines appear every time you shift to reverse, even if you turned them off the last time.

Before you begin driving your vehicle, you should know what gasoline to use and how to check the levels of important fluids. You also need to know how to properly store luggage or packages. The information in this section will help you. If you plan to add any accessories to your vehicle, please read the information in this section first.

Break-in Period	422
Fuel Recommendation	422
Service Station Procedures	424
Refueling.....	424
Tighten Fuel Cap Message	425
Opening and Closing the Hood.....	426
Oil Check.....	427
Engine Coolant Check	427
Fuel Economy.....	428
Accessories and Modifications	431
Carrying Cargo	433

Break-in Period, Fuel Recommendation

Break-in Period

Help assure your vehicle's future reliability and performance by paying extra attention to how you drive during the first 600 miles (1,000 km). During this period:

- Avoid full-throttle starts and rapid acceleration.
- Avoid hard braking for the first 200 miles (300 km).
- Do not change the oil until the multi-information display indicates it is needed.
- Do not tow a trailer.

You should also follow these recommendations with an overhauled or exchanged engine, or when the brakes are replaced.

Fuel Recommendation

Your vehicle is designed to operate on premium unleaded gasoline with a pump octane of 91 or higher. If this octane grade is unavailable, regular unleaded gasoline with a pump octane of 87 or higher may be used temporarily. The use of regular unleaded gasoline can cause metallic knocking noises in the engine and will result in decreased engine performance. The long-term use of regular-grade gasoline can lead to engine damage.

NOTICE

To help prevent harmful fuel system and engine deposits, use high quality fuel containing detergent and additives. In addition, in order to maintain good performance, fuel economy, and emissions control, we strongly recommend the use of gasoline that does NOT contain harmful manganesebased fuel additives such as MMT, if such gasoline is available.

Use of gasoline with these additives may adversely affect performance, and cause the malfunction indicator lamp on your instrument panel to come on. If this happens, contact your dealer for service.

Some gasoline today is blended with oxygenates such as ethanol or MTBE. Your vehicle is designed to operate on oxygenated gasoline containing up to 10% ethanol by volume and up to 15% MTBE by volume. Do not use gasoline containing methanol.

If you notice any undesirable operating symptoms, try another service station or switch to another brand of gasoline.

Because the level of detergency and additives in gasoline vary in the market, Honda endorses the use of “TOP TIER Detergent Gasoline” where available to help maintain the performance and reliability of your vehicle. TOP TIER Detergent Gasoline meets a new gasoline standard jointly established by leading automotive manufacturers to meet the needs of today’s advanced engines. Qualifying gasoline retailers will, in most cases, identify their gasoline as having met “TOP TIER Detergent Gasoline” standards at the retail location. This fuel is guaranteed to contain the proper level of detergent additives and be free of metallic additives. The proper level of detergent additives, and absence of harmful metallic additives in gasoline, help avoid build-up of deposits in your engine and emission control system.

For further important fuel-related information for your vehicle, or information on gasoline that does not contain MMT, visit My Acura at owners.acura.com. In Canada, visit www.acura.ca for additional information on gasoline.

Service Station Procedures

Refueling

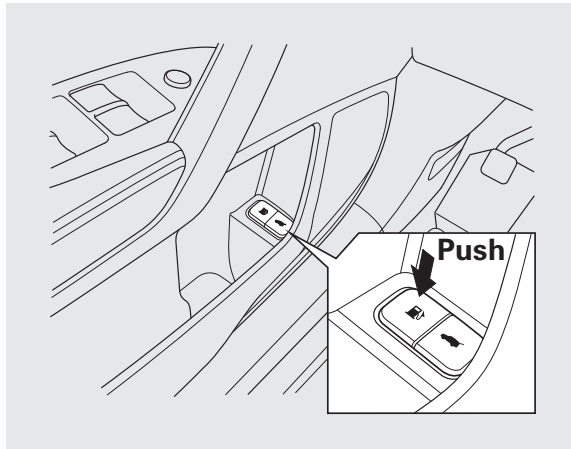

1. Park with the driver's side closest to the service station pump.
2. Open the fuel fill door by pressing the button in the driver's door. (To open the fuel fill door manually, see page 572.)

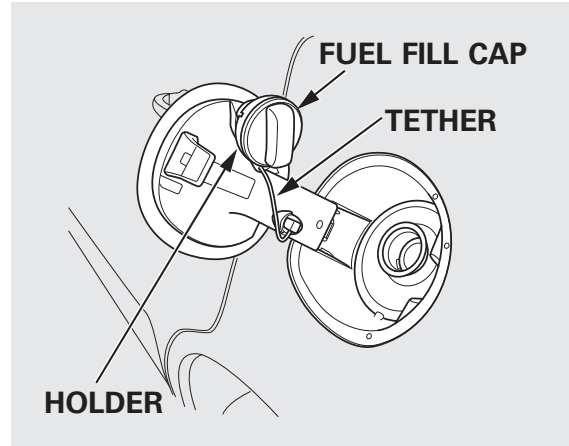

3. Remove the fuel fill cap slowly. You may hear a hissing sound as pressure inside the tank equalizes. Place the cap in the holder on the fuel fill door.
4. Stop filling the tank after the fuel nozzle automatically clicks off. Do not try to “top off” the tank. Leave some room for the fuel to expand with temperature changes.

If the fuel nozzle keeps clicking off even though the tank is not full, there may be a problem with your vehicle's fuel vapor recovery system. The system helps keep fuel vapor from going into the atmosphere. Try filling at another pump. If this does not fix the problem, consult your dealer.

⚠ WARNING

Gasoline is highly flammable and explosive. You can be burned or seriously injured when handling fuel.

- Stop the engine, and keep heat, sparks, and flame away.
- Handle fuel only outdoors.
- Wipe up spills immediately.

5. Screw the fuel fill cap back on until it clicks at least once. If you do not properly tighten the cap, you will see a “TIGHTEN FUEL CAP” message on the multi-information display (see right column on this page), and the malfunction indicator lamp may also come on (see page 563).
6. Push the fuel fill door closed until it latches.

Tighten Fuel Cap Message



Your vehicle's on board diagnostic system will detect a loose or missing fuel fill cap as an evaporative system leak. The first time a leak is detected a “TIGHTEN FUEL CAP” message appears on the multi-information display. Turn the engine off, and confirm the fuel fill cap is installed. If it is, loosen it, then retighten it until it clicks at least once. The message should go off after several days of normal driving once you tighten or replace the fuel fill cap. To scroll to another message, press the INFO button. The “TIGHTEN FUEL CAP” message will appear each time you restart the engine until the system turns the message off.

If the system still detects a leak in the vehicle's evaporative emissions system, the malfunction indicator lamp (MIL) comes on. If the fuel fill cap was not already tightened, turn the engine off, and check or retighten the fuel fill cap until it clicks at least once. The MIL should go off after several days of normal driving once the cap is tightened or replaced. If the MIL does not go off, have your vehicle inspected by a dealer. For more information, see page 563.

Service Station Procedures

Opening and Closing the Hood



1. Park the vehicle, and set the parking brake. Pull the hood release handle located under the lower left corner of the dashboard. The hood will pop up slightly.

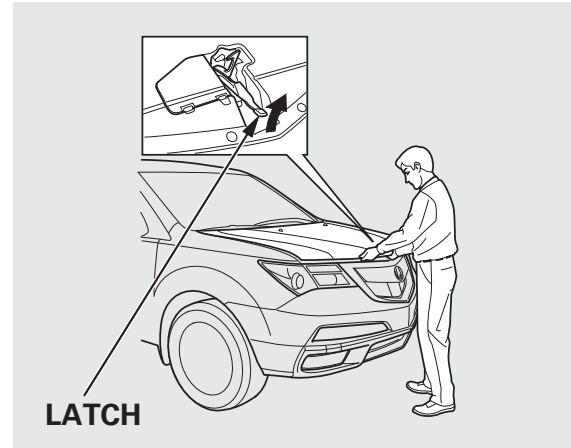

2. Put your fingers under the front edge of the hood near the center. Slide your hand to your left until you feel the hood latch handle. Push this handle up until it releases the hood. Lift up the hood.

If the hood latch handle moves stiffly, or if you can open the hood without lifting the handle, the mechanism should be cleaned and lubricated.

3. Lift the hood up most of the way. The hydraulic supports will lift it up the rest of the way and hold it up.

To close the hood, lower the hood to about a foot (30 cm) above the fender, then press down firmly with your hands. Make sure it is securely latched.

Oil Check

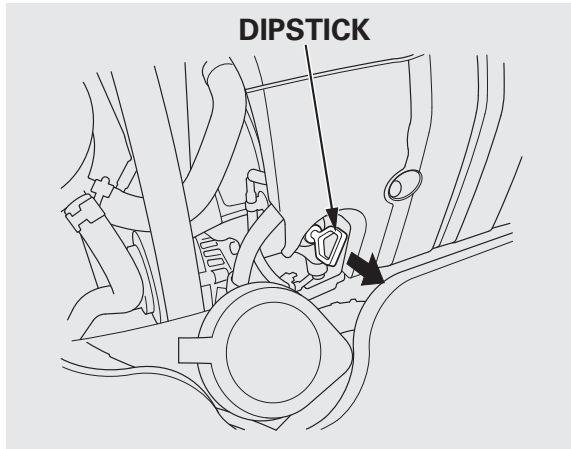

Wait a few minutes after turning the engine off before you check the oil.

1. Remove the dipstick (orange loop).
2. Wipe off the dipstick with a clean cloth or paper towel.
3. Insert the dipstick all the way back into its hole.

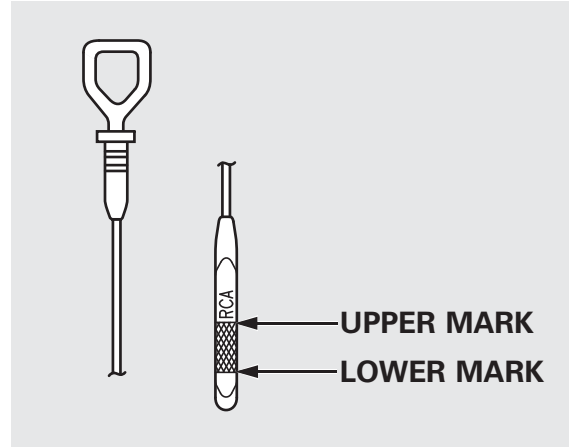

4. Remove the dipstick again, and check the level. It should be between the upper and lower marks.

If it is near or below the lower mark, see **Adding Engine Oil** on page 517.

Engine Coolant Check

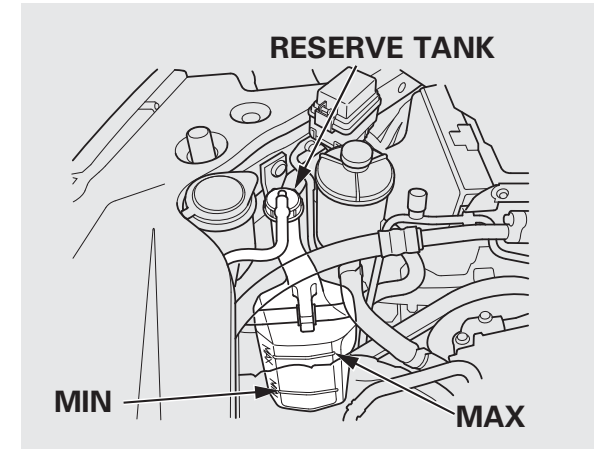

Look at the coolant level in the radiator reserve tank. Make sure it is between the MAX and MIN lines. If it is below the MIN line, see **Adding Engine Coolant** on page 520 for information on adding the proper coolant.

Refer to **Owner's Maintenance Checks** on page 513 for information about checking other items on your vehicle.

CONTINUED

Fuel Economy

Actual Mileage and EPA Fuel Economy Estimates Comparison. Fuel economy is not a fixed number. It varies based on driving conditions, driving habits and vehicle condition. Therefore, it is not possible for one set of estimates to predict fuel economy precisely for all drivers in all environments.

The EPA fuel economy estimates shown in the example to the right are a useful tool for comparison when buying a vehicle. EPA estimates include:

City MPG – Represents urban driving in a vehicle in light traffic. A range of miles per gallon achieved is also provided.

Highway MPG – Represents a mixture of rural and interstate driving, in a warmed-up vehicle, typical of longer trips in free-flowing traffic. A range of miles per gallon achieved is also provided.

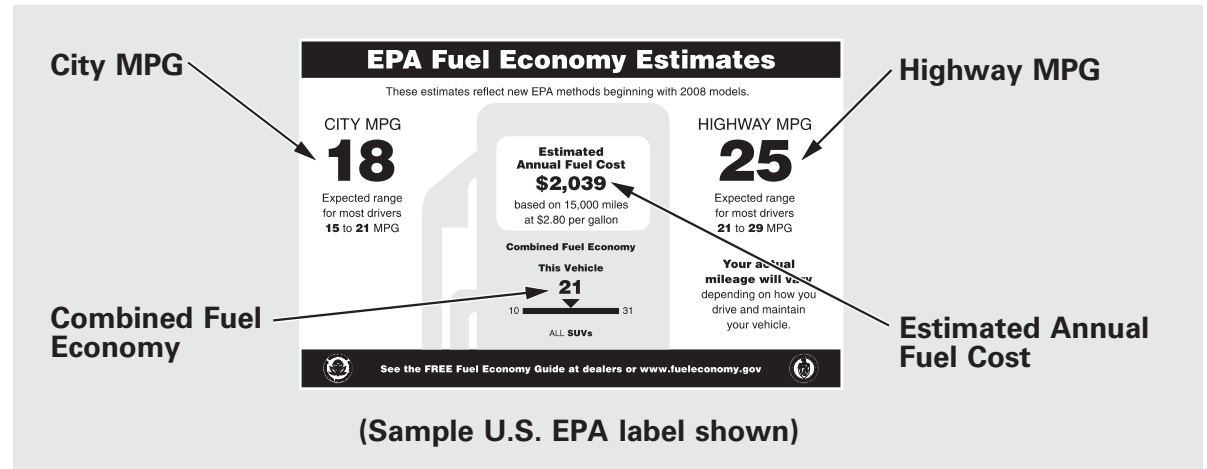

Combined Fuel Economy – Represents a combination of city and highway driving. The scale represents the range of combined fuel economy for other vehicles in the class.

Estimated Annual Fuel Cost – Provides an estimated annual fuel cost, based on 15,000 miles in the U.S. or 20,000 km in Canada per year multiplied by the cost per gallon (based on EPA fuel cost data) divided by the combined fuel economy.

For more information on fuel economy ratings and factors that affect fuel economy, visit www.fueleconomy.gov (Canada: Visit www.vehicles.gc.ca)

Fuel Economy Factors

The following factors can lower your vehicle's fuel economy:

- Aggressive driving (hard acceleration and braking)
- Excessive idling, accelerating and braking in stop-and-go traffic
- Cold engine operation (engines are more efficient when warmed up)
- Driving with a heavy load or the air conditioner running
- Improperly inflated tires

Improving Fuel Economy

Vehicle Maintenance

A properly maintained vehicle maximizes fuel economy. Poor maintenance can significantly reduce fuel economy. Always maintain your vehicle according to the maintenance messages displayed on the multi-information display (see **Owner's Maintenance Checks** on page 513).

For example:

- **Use the recommended viscosity motor oil, displaying the API Certification Seal (see page 517).**
- **Maintain proper tire inflation** – An underinflated tire increases “rolling resistance,” which reduces fuel economy.
- **Avoid carrying excess weight in your vehicle** – It puts a heavier load on the engine, increasing fuel consumption.
- **Keep your vehicle clean** – In particular, a build-up of snow or mud on your vehicle's underside adds weight and rolling resistance. Frequent cleaning helps your fuel economy.

Drive Efficiently

- **Drive moderately** – Rapid acceleration, abrupt cornering, and hard braking increase fuel consumption.

- **Observe the speed limit** – Aerodynamic drag has a big effect on fuel economy at speeds above 45 mph (75 km/h). Reduce your speed and you reduce the drag. Trailers, car top carriers, roof racks and bike racks are also big contributors to increased drag.
- **Always drive in the highest gear possible** – If your vehicle has a manual transmission, you can boost your fuel economy by up shifting as early as possible.
- **Avoid excessive idling** – Idling results in 0 miles per gallon (0 kms per liter).

CONTINUED

Fuel Economy

- **Minimize the use of the air conditioning system** – The A/C puts an extra load on the engine which makes it use more fuel. Use the fresh-air ventilation when possible.
- **Plan and combine trips** – Combine several short trips into one. A warmed-up engine is more fuel efficient than a cold one.

Calculating Fuel Economy

Measuring Techniques

Direct calculation is the recommended source of information about your actual fuel economy. Using frequency of fill-ups or taking fuel gauge readings are NOT accurate measures of fuel economy. Fuel economy may improve over the first several thousand miles (kilometers).

Checking Your Fuel Economy

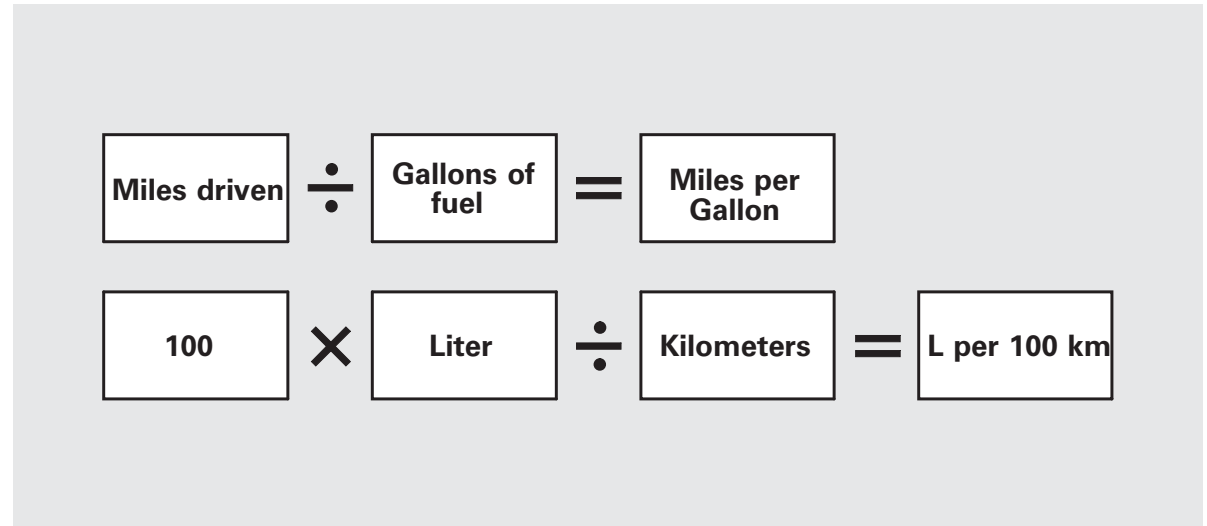

- 1) Fill the fuel tank until the nozzle automatically clicks off.
- 2) Reset trip counter to zero.
- 3) Record the total gallons (liters) needed to refill.
- 4) Follow one of the simple calculations above.

Modifying your vehicle, or installing non-Acura accessories, may make your vehicle unsafe. Before you make any modifications or add any accessories, be sure to read the following information.

Accessories

Your dealer has Acura accessories that allow you to personalize your vehicle. These accessories have been designed and approved for your vehicle, and are covered by warranty.

Although non-Acura accessories may fit on your vehicle, they may not meet factory specifications, and could adversely affect your vehicle's handling, stability, and reliability.

⚠ WARNING

Improper accessories or modifications can affect your vehicle's handling, stability, and performance, and cause a crash in which you can be hurt or killed.

Follow all instructions in this owner's manual regarding accessories and modifications.

When properly installed, cellular phones, alarms, two-way radios, and low-powered audio systems should not interfere with your vehicle's computer controlled systems, such as your airbags, anti-lock brakes, and tire pressure monitoring system.

Before installing any accessory:

- Make sure the accessory does not obscure any lights, or interfere with proper vehicle operation or performance.
- Be sure electronic accessories do not overload electrical circuits (see page 566) or interfere with proper operation of your vehicle.
- Do not install accessories on the side pillars or across the rear windows. Accessories installed in these areas may interfere with proper operation of the side curtain airbags.
- Before installing any electronic accessory, have the installer contact your dealer for assistance. If possible, have your dealer inspect the final installation.

CONTINUED

Accessories and Modifications

Modifying Your Vehicle

Removing parts from your vehicle, or replacing components with non-Acura components could seriously affect your vehicle's handling, stability, and reliability.

Some examples are:

- Lowering your vehicle with a non-Acura suspension kit that significantly reduces ground clearance can allow the undercarriage to hit speed bumps or other raised objects, which could cause the airbags to deploy.
- Raising your vehicle with a non-Acura suspension kit can affect the handling and stability.
- Non-Acura wheels, because they are a universal design, can cause excessive stress on suspension components and will not be compatible with the tire pressure monitoring system (TPMS).

- Larger or smaller wheels and tires can interfere with the operation of your vehicle's anti-lock brakes and other systems.

Modifying your steering wheel or any other part of your vehicle's safety features can make the systems ineffective.

If you plan to modify your vehicle, consult your dealer.

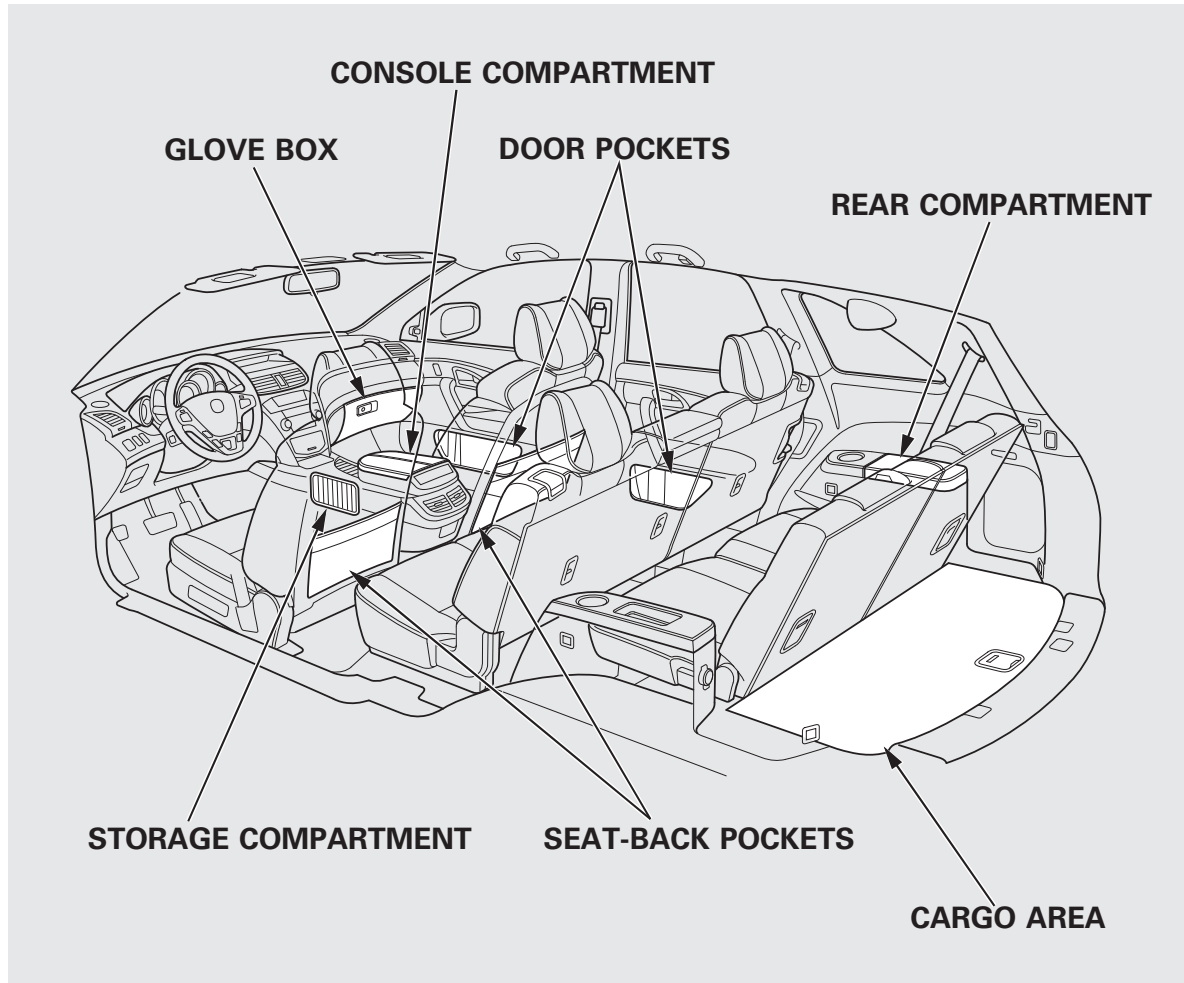

Your vehicle has several convenient storage areas:

- Glove box
- Door and seat-back pockets
- Rear cargo area, including the second and third row seats when folded flat
- Console compartment
- Storage compartment
- Rear compartment
- Roof-rack (if equipped)

However, carrying too much cargo, or improperly storing it, can affect your vehicle's handling, stability, stopping distance, and tires, and make it unsafe. Before carrying any type of cargo, be sure to read the following pages.

CONTINUED

Carrying Cargo

Load Limits

The maximum load for your vehicle is 1,150 lbs (525 kg).

See Tire And Loading Information label attached to the driver's doorjamb.

Label Example

TIRE AND LOADING INFORMATION			
SEATING CAPACITY : TOTAL 5 ; FRONT 2 ; REAR 3			
The combined weight of occupants and cargo should never exceed 385kg or 850lbs.			
TIRE	SIZE	COLD TIRE PRESSURE	SEE OWNER'S MANUAL FOR ADDITIONAL INFORMATION
FRONT	XXXX/XXXXX XXX	XXXKPA, XXPSI	
REAR	XXXX/XXXXX XXX	XXXKPA, XXPSI	
SPARE	XXXX/XXXXX XXX	XXXKPA, XXPSI	

This figure includes the total weight of all occupants, cargo, and accessories, and the tongue load if you are towing a trailer.

⚠ WARNING



Overloading or improper loading can affect handling and stability and cause a crash in which you can be hurt or killed.

Follow all load limits and other loading guidelines in this manual.

Steps for Determining Correct Load Limit –

- (1) Locate the statement “The combined weight of occupants and cargo should never exceed XXX kg or XXX lbs.” on your vehicle's placard.
- (2) Determine the combined weight of the driver and passengers that will be riding in your vehicle.
- (3) Subtract the combined weight of the driver and passengers from XXX kg or XXX lbs.
- (4) The resulting figure equals the available amount of cargo and luggage load capacity. For example, if the “XXX” amount equals 1,400 lbs. and there will be five 150 lb. passengers in your vehicle, the amount of available cargo and luggage load capacity is 650 lbs.
 $(1,400 - 750 (5 \times 150) = 650$ lbs.)
- (5) Determine the combined weight of luggage and cargo being loaded on the vehicle. That weight may not safely exceed the available cargo and luggage load capacity calculated in Step 4.
- (6) If your vehicle will be towing a trailer, load from your trailer will be transferred to your vehicle. Consult this manual to determine how this reduces the available cargo and luggage load capacity of your vehicle.

Carrying Cargo

<p>Example 1</p>	 <p>Max Load (1,150 lbs) (525 kg)</p> <p>Passenger Weight (150 lbs x 2 = 300 lbs) (68 kg x 2 = 136 kg)</p> <p>Cargo Weight (850 lbs) (389 kg)</p>
<p>Example 2</p>	 <p>Max Load (1,150 lbs) (525 kg)</p> <p>Passenger Weight (150 lbs x 4 = 600 lbs) (68 kg x 4 = 272 kg)</p> <p>Cargo Weight (550 lbs) (253 kg)</p>
<p>Example 3</p>	 <p>Max Load (1,150 lbs) (525 kg)</p> <p>Passenger Weight (150 lbs x 5 = 750 lbs) (68 kg x 5 = 340 kg)</p> <p>Cargo Weight (400 lbs) (185 kg)</p>

In addition, the total weight of the vehicle, all occupants, accessories, cargo, and trailer tongue load must not exceed the Gross Vehicle Weight Rating (GVWR) or the Gross Axle Weight Rating (GAWR). Both are on a label on the driver's doorjamb.

Carrying Cargo

Carrying Cargo in the Passenger Compartment

- Store or secure all items that could be thrown around and hurt someone during a crash.
- Be sure items placed on the floor behind the front seats cannot roll underneath and interfere with the proper operation of the seats, the sensors under the seats, or the driver's ability to operate the pedals.

Also, keep all cargo below the bottom of the windows. If it is higher, it could interfere with the proper operation of the side curtain airbags.

- Keep the glove box closed while driving. If it is open, a passenger could injure their knees during a crash or sudden stop.

Carrying Cargo in the Cargo Area or on a Roof Rack

- Distribute cargo evenly on the floor of the cargo area, placing the heaviest items on the bottom and as far forward as possible. Tie down items that could be thrown about the vehicle during a crash or sudden stop.
- If you fold down the second or third row seats, tie down items that could be thrown about the vehicle during a crash or sudden stop.

- If you carry large items that prevent you from closing the tailgate, exhaust gas can enter the passenger area. To avoid the possibility of **carbon monoxide poisoning**, follow the instructions on page 61.
- If you carry any items on a roof rack, be sure the total weight of the rack and the items does not exceed 165 lbs (75 kg).

Optional Separation Net

The separation net can be used to hold back soft, lightweight items stored in the cargo area. Heavy items should be tied down, as the net may not prevent them from being thrown about the vehicle in a crash or a sudden stop.

Optional Cargo Cover

The cargo cover can be used to cover the cargo area behind the third row seats. When the third row seats are folded down, the cargo cover can be extended over the larger area. Do not install the cover over the larger area if the third row seats are not folded down.

Cargo Hooks

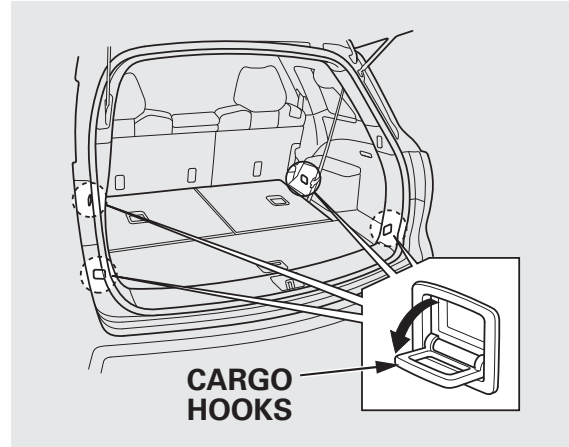

The four hooks on the side panels can be used to install a net for securing items. Each hook is designed to hold up to 50 lbs (23 kg) of weight.



Your vehicle also has a grocery hook on each side panel in the cargo area. They are designed to hold light items. Heavy objects may damage the hook. Make sure any items put on each hook weigh less than 6.5 lbs (3 kg).

This section gives you tips on starting the engine under various conditions, and how to operate the automatic transmission. It also includes important information on parking your vehicle, the braking system, the Super Handling-All Wheel Drive™ (SH-AWD®) system, the vehicle stability assist (VSA®) system, active damper system (If equipped), the tire pressure monitoring system (TPMS), the collision mitigation braking system™ (CMBS™), the blind spot information system (BSI) and facts you need if you are planning to tow a trailer or drive off-high way.

Driving Guidelines.....	440	Vehicle Stability Assist (VSA®), aka Electronic Stability Control (ESC), System.....	473
Preparing to Drive	441	Blind Spot Information System (BSI)	476
Starting the Engine	442	Active Damper System.....	484
Check Starting System		Towing a Trailer.....	487
Message	443	Trailer Stability Assist	498
Automatic Transmission	443	Off-Highway Driving Guidelines.....	500
Driving with the Paddle			
Shifters.....	447		
Using the Paddle Shifters in the D position (D-Paddle Shift Mode)	447		
Using the Paddle Shifters in the S position (Sequential Shift Mode)	449		
Super Handling-All Wheel Drive™ (SH-AWD®)			
System	452		
Parking	454		
Tire Pressure Monitoring System (TPMS)	455		
Braking System	460		
Anti-lock Brakes (ABS)	461		
Collision Mitigation Braking System™ (CMBS™)	463		

Driving Guidelines

Your vehicle has higher ground clearance that allows you to travel over bumps, obstacles, and rough terrain. It also provides good visibility so you can anticipate problems earlier.

Because your vehicle rides higher off the ground, it has a high center of gravity that can cause it to roll over if you make abrupt turns. Utility vehicles have a significantly higher roll over rate than other types of vehicles.

To prevent rollovers or loss of control:

- Take corners at slower speeds than you would with a passenger vehicle.
- Avoid sharp turns and abrupt maneuvers whenever possible.
- Do not modify your vehicle in any way that would raise the center of gravity.
- Do not carry heavy cargo on the roof.

Your vehicle is equipped with a super handling-all wheel drive (SH-AWD) system. When the system senses a loss of one or more wheel traction, it automatically transfers some power to the other wheels. This gives you better traction and mobility.

You still need to exercise the same care when accelerating, steering, and braking that you would in a two-wheel drive vehicle.

See page 500 for off-highway driving guidelines.

You should do the following checks and adjustments before you drive your vehicle.

1. Make sure all windows, mirrors, and outside lights are clean and unobstructed. Remove frost, snow, or ice.
2. Check that the hood is fully closed.
3. Visually check the tires. If a tire looks low, use a gauge to check its pressure.
4. Check that any items you may be carrying are stored properly or fastened down securely.
5. Check the seat adjustment (see page 149).
6. Check the adjustment of the inside and outside mirrors (see page 165).
7. Check the steering wheel adjustment (see page 134).
8. Make sure the doors and tailgate are securely closed and locked.
9. Fasten your seat belt. Check that your passengers have fastened their seat belts (see page 16).
10. When you start the engine, check the gauges and indicators in the instrument panel, and the messages on the multi-information display (see pages 67, 78 and 87).

Starting the Engine

Your vehicle's starting system has an auto control mode. When you turn the ignition switch to the START (III) position, this feature keeps the engine's starter motor running until the engine starts. Follow these instructions to start the engine:

1. Apply the parking brake.
2. In cold weather, turn off all electrical accessories to reduce the drain on the battery.
3. Make sure the shift lever is in Park. Press on the brake pedal.

4. Without touching the accelerator pedal, turn the ignition switch to the START (III) position, then release the ignition switch. You do not need to hold the ignition switch in the START (III) position to start the engine. Depending on the outside temperature, the starter motor runs for about 6 to 9 seconds until the engine starts.

If you hold the ignition switch in the START (III) position for more than 7 seconds, the starter motor, depending on the outside temperature, runs for about 10 to 25 seconds until the engine starts.

If the engine does not start, wait at least 10 seconds before trying again.

NOTICE

The immobilizer system protects your vehicle from theft. If an improperly-coded key (or other device) is used, the engine's fuel system is disabled. For more information, see page 138.

The engine is harder to start in cold weather. Also, the thinner air found at altitudes above 8,000 feet (2,400 meters) adds to this problem.

Starting the Engine, Automatic Transmission

Check Starting System Message

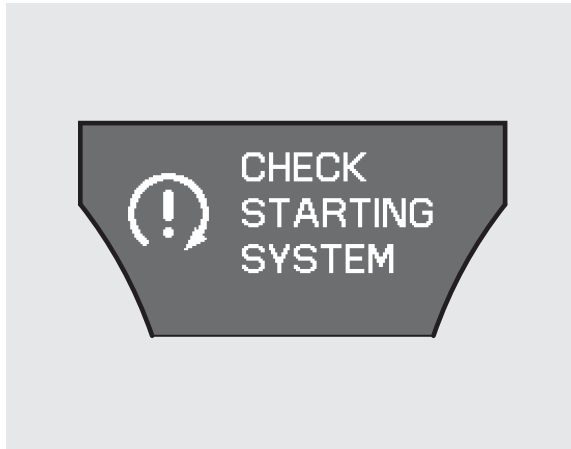

If there is a problem with the starting system, you will see a “CHECK STARTING SYSTEM” message on the multi-information display when the ignition switch is turned to the ON (II) position. You will also see this message when the auto control mode of the starting system has a problem.

If this message is on, the ignition switch has to be held in the START (III) position manually until the engine starts. The ignition switch can be held in that position up to 15 seconds.

Even though you may be able to start the engine manually without the auto control mode of the starting system, have your dealer inspect your vehicle.

Shift Lever Position Indicators

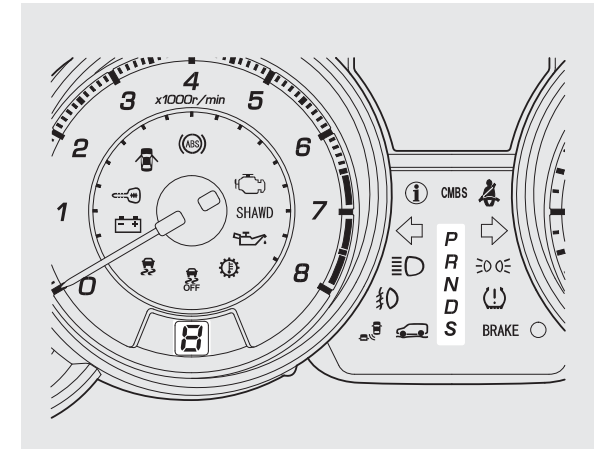

These indicators on the instrument panel show which position the shift lever is in.

The “D” indicator comes on for a few seconds when you turn the ignition switch to the ON (II) position. If it flashes while driving (in any shift position), it indicates a possible problem in the transmission.

CONTINUED

Automatic Transmission

If the malfunction indicator lamp comes on along with the “D” indicator, there is a problem with the automatic transmission control system. Avoid rapid acceleration, and have the transmission checked by your dealer as soon as possible.

When the “D” indicator warns of a possible problem with the transmission, you will see a “CHECK TRANSMISSION” message on the multi-information display (see page 88).

Shifting

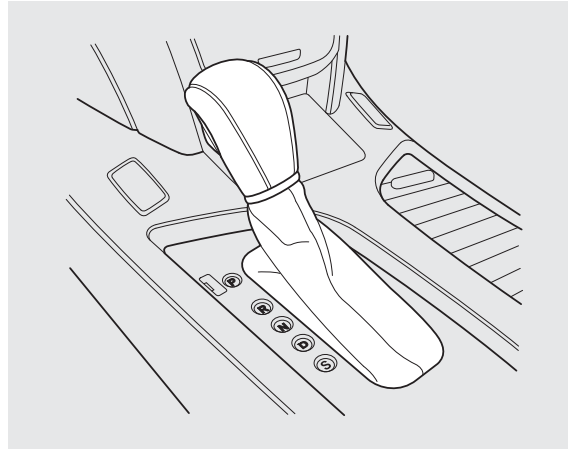

To shift from Park to any position, press firmly on the brake pedal, and press the release button on the front of the shift lever, then move the lever. You cannot shift out of Park when the ignition switch is in the LOCK (0) or ACCESSORY (I) position.

To shift from:	Do this:
P to R	Press the brake pedal, and press the shift lever release button.
R to P N to R D to S	Press the shift lever release button.
S to D D to N N to D R to N	Move the shift lever.

Park (P) – This position mechanically locks the transmission. Use Park whenever you are turning off or starting the engine. To shift out of Park, you must press on the brake pedal and press the release button on the shift lever. Make sure your foot is off the accelerator pedal.

If you have done all of the above and still cannot move the lever out of Park, see **Shift Lock Release** on page 446.

To avoid transmission damage, come to a complete stop before shifting into Park. You must also press the release button to shift into park. The shift lever must be in Park before you can remove the key from the ignition switch.

Reverse (R) – Press the brake pedal and the release button on the front of the shift lever to shift from Park to reverse. To shift from reverse to neutral, come to a complete stop, and then shift. Press the release button before shifting into reverse from neutral.

Neutral (N) – Use neutral if you need to restart a stalled engine, or if it is necessary to stop briefly with the engine idling. Shift to the Park position if you need to leave your vehicle for any reason. Press on the brake pedal when you are moving the shift lever from neutral to another gear.

Drive (D) – Use this position for your normal driving. The transmission automatically selects a suitable gear (1 through 6) for your speed and acceleration. You may notice the transmission shifting up at higher engine speeds when the engine is cold. This helps the engine warm up faster.

S Position (S) – To shift into the S position, press the release button on the front of the shift lever, and move the lever to S. This position is similar to D, except only gears from first to fifth are selected. (When shifting up automatically, the vehicle speed is higher than when in the D position.) The S position keeps the transmission from cycling between fourth, fifth, and sixth gears in stop-and-go driving.

With the shift lever in D or S, you can also use the paddle shifters to shift the transmission up or down. Once you begin to use the paddle shifters in S, the transmission will no longer upshift or downshift automatically. For more information of driving with the paddle shifters, see page 449.

CONTINUED

Automatic Transmission

Engine Speed Limiter

If you exceed the maximum speed for the gear you are in, the engine speed will enter into the tachometer's red zone. If this occurs, you may feel the engine cut in and out. This is caused by a limiter in the engine's computer controls. The engine will run normally when you reduce the rpm below the red zone.

Before downshifting, make sure the engine will not go into the tachometer's red zone.

The engine may cut in and out in R position or depending on the road condition even when the engine speed is lower than the tachometer's red zone. This is the engine's computer working to protect the transmission.

Shift Lock Release

This allows you to move the shift lever out of Park if the normal method of pushing on the brake pedal and pressing the release button does not work.

1. Set the parking brake.
2. Remove the key from the ignition switch.

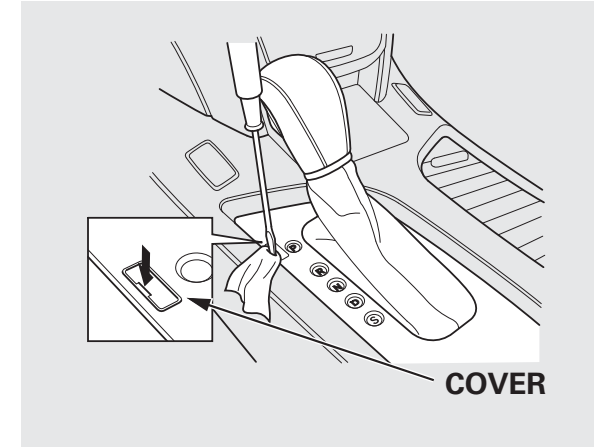

3. Put a cloth on the edge of the shift lock release slot cover. Use a small flat-tip screwdriver or metal fingernail file to carefully pry up the edge of the cover and remove it from the slot.

Automatic Transmission, Driving with the Paddle Shifters

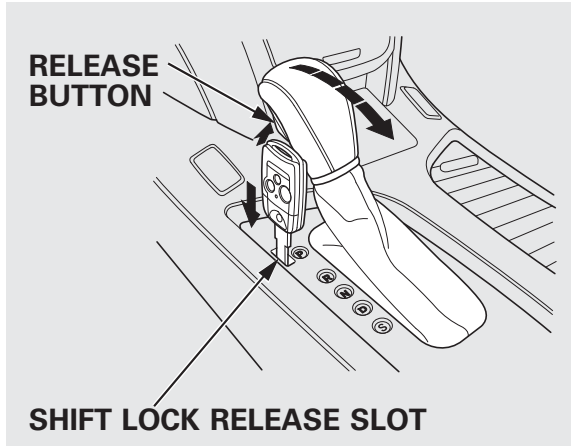

4. Insert a key into the shift lock release slot.
5. Push down on the key while you press the release button on the front of the shift lever and move the shift lever out of Park to neutral.

6. Remove the key from the shift lock release slot, then reinstall the cover. Make sure the notch on the cover is on the driver's side. Press the brake pedal, and restart the engine.

If you need to use the shift lock release, it means your vehicle is developing a problem. Have the vehicle checked by a dealer.

Using the Paddle Shifters in the D position (D-Paddle Shift Mode)

When you are driving in the D position, pulling either paddle shifter switches from D-normal drive mode, to D-paddle shift mode. You can shift the transmission up or down manually with the paddle shifters.

Downshifting gives you more power when climbing, and provides engine braking when going down a steep hill.

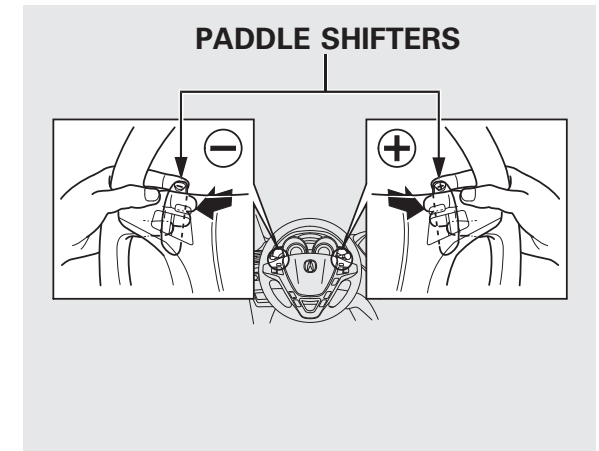

CONTINUED

Driving with the Paddle Shifters

To shift up or down, use the + (right) or - (left) paddle shifter on either side of the steering wheel.

Each time you pull + (right), the transmission shifts to a higher gear. Pull - (left) to downshift. You will see the selected gear number on the instrument panel.

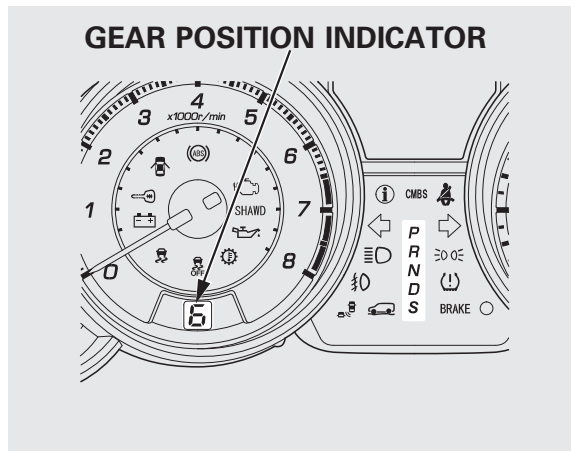

When you pull either paddle shifter, the gear position indicator shows you the selected gear number.

The transmission control system monitors the accelerator pedal use and your driving conditions. When you press the accelerator pedal as in normal driving, the system judges that you are driving at a constant cruising speed without using the paddle shifters. Under these conditions, D-paddle shift mode is canceled, and the transmission automatically returns to drive mode (D).

Hold the + (right) paddle shifter for 2 seconds to return to drive mode (D).

When the transmission returns to drive mode (D), the displayed gear number goes out.

The transmission remains in the selected gear if you do not accelerate.

Each time you pull either paddle shifter, the transmission shifts one gear up or down. If you want to shift up or down more than two gears, pull the paddle shifter twice, pause, and then pull it again.

The automatic transmission will not allow you to shift up or down if:

- You downshift before the engine speed reaches the highest threshold of the lower gear.
If you try to do this, the gear position indicator will flash the number of the lower gear several times, then return to a higher gear.
- You upshift before the engine speed reaches the lowest threshold of the higher gear.
- You press both paddle shifters at the same time.

- You press one of the two paddle shifters while another paddle shifter is being pressed.
- You are trying to downshift from second to first with the accelerator pedal off. This will only work when the accelerator pedal is applied deeply.

The transmission downshifts to first gear and returns to drive mode (D) when the vehicle comes to a complete stop and the vehicle speed is about 6 mph (9 km/h).

If there is a problem in the transmission while you are driving with the paddle shifters, the D indicator flashes, the D-paddle shift mode is canceled, and the transmission returns to drive mode (D).

Using the Paddle Shifters in the S position (Sequential Shift Mode)

With the shift lever in the S position, you can select the sequential shift mode to shift gears; much like a manual transmission using the paddle shifters, but without a clutch pedal.

To enter the sequential shift mode, press the release button on the front of the shift lever, move the lever to the S position, then pull either paddle shifter. To cancel the sequential shift mode and return to the ordinary automatic transmission, move the shift lever from S position. When moving the shift lever, be careful not to operate incorrectly. While you are driving in the sequential shift mode, the transmission will not automatically return to ordinary automatic transmission.

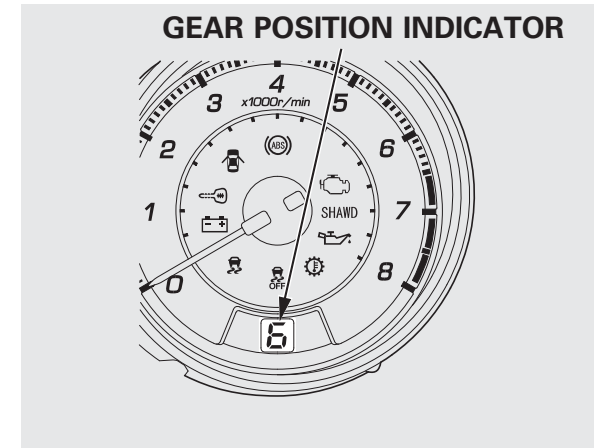

When you move the shift lever from “D” to “S” position and pull either paddle shifter, the gear position indicator displays the selected gear number.

Shifting between first and second gears may occur automatically. Downshifting from second to first with the accelerator pedal off is not allowed.

CONTINUED

Driving with the Paddle Shifters

To upshift, pull the + (right) paddle shifter. To downshift, pull the – (left) paddle shifter.

When you accelerate from a stop, the transmission starts in first gear, and shifts from first to second automatically. You must manually upshift between second and sixth gears. Make sure you upshift before the engine speed reaches the tachometer's red zone.

The transmission remains in the selected gear (6, 5, 4, 3, or 2). There is no automatic downshift when you push the accelerator pedal to the floor.

When you are driving, the transmission downshifts to the lower gear under the following conditions:

- The vehicle slows down to a certain speed.
- You press the brake pedal.

Downshifting with the paddle shifter allows you to increase the engine braking when going down steep or long hills, and provides more power when climbing uphill. You can upshift the transmission manually to reduce the rpm.

The transmission also shifts automatically as the vehicle comes to a complete stop. It downshifts to first gear when the vehicle speed reaches 6 mph (9 km/h) or less.

The automatic transmission will not allow you to shift up or down if:

- You downshift before the engine speed reaches the highest threshold of the lower gear.

If you try to do this, the gear position indicator will flash the number of the lower gear several times, then return to a higher gear.

- You cannot upshift with the paddle shifter before the engine speed reaches the lowest threshold of the higher gear.
- You try to shift to third or a higher gear when the vehicle is stationary.
- You press both paddle shifters at the same time.
- You press one of the two paddle shifters while another paddle shifter is being pressed.
- The vehicle detects that you are driving uphill or downhill.

Starting in Second Gear

When you are in sequential shift mode, and the vehicle is stopped, pull the + (right) paddle shifter to shift to second gear. You will see “2” in the display. Starting in second gear helps to reduce wheelspin in deep snow or on a slippery surface.

Recommended Shift Points

Drive in the highest gear that lets the engine run and accelerate smoothly. This will give you good fuel economy and effective emissions control. The following shift points are recommended:

Shift Up	Normal acceleration
1st to 2nd	15 mph (24 km/h)
2nd to 3rd	25 mph (40 km/h)
3rd to 4th	40 mph (64 km/h)
4th to 5th	45 mph (72 km/h)
5th to 6th	50 mph (80 km/h)

Super Handling-All Wheel Drive™ (SH-AWD®) System

The super handling-all wheel drive (SH-AWD) system is a full time all-wheel-drive system that automatically controls and transfers varying amounts of engine torque to all wheels independently, according to the driving conditions.

While the SH-AWD system helps to enhance the vehicle's driving stability in all situations, it is still your responsibility to drive and corner at reasonable speeds and to leave a sufficient margin of safety.

SH-AWD Torque Distribution Monitor

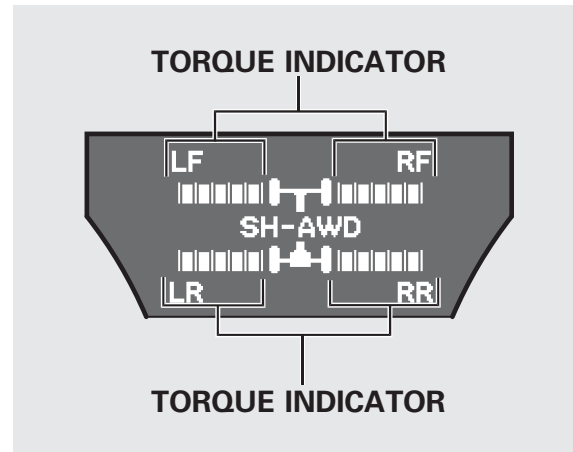

The SH-AWD torque distribution monitor on the multi-information display shows you the amount of torque being sent to the wheels. Each wheel-right front (RF), left front (LF), right rear (RR), and left rear (LR)-has its own torque indicator.

Each torque indicator is displayed as a bar graph divided into 5 segments. The number of segments represents the amount of torque distributed to each wheel.

When there is only a slight change in torque distribution while driving, such as cruising on level roads at the same speed, the torque distribution monitor may stop displaying the amount of torque. This is not a system problem. The monitor will show the amount if the system senses any change in torque distribution.

Super Handling-All Wheel Drive™ (SH-AWD®) System

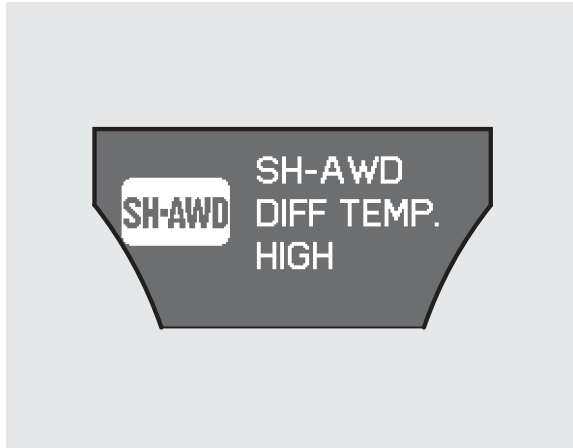

If the SH-AWD indicator blinks while driving, it indicates the differential temperature is too high. You will also see an “SH-AWD DIFF TEMP. HIGH” message on the multi-information display. If this happens, pull to the side of the road when it is safe, shift to Park, and let the engine idle until the indicator goes out. If the indicator does not go out, take your vehicle to a dealer to have it checked.

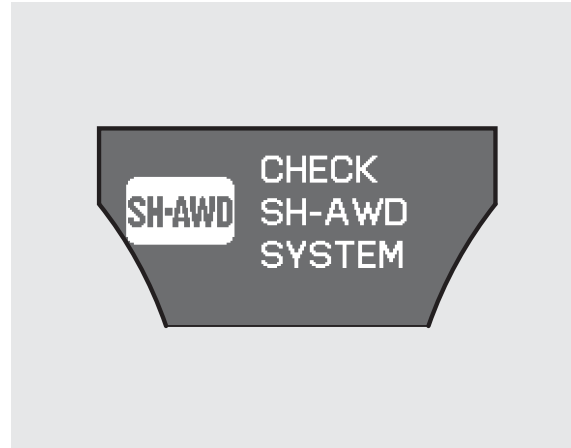

If the SH-AWD indicator on the instrument panel stays on, and the “CHECK SH-AWD SYSTEM” message also appears on the multi-information display, there is problem with the SH-AWD system.

Your vehicle still has normal front-wheel drive with vehicle stability assist (VSA), but does not have the advantages of SH-AWD. Have your vehicle checked by a dealer as soon as possible.

Parking

Always use the parking brake when you park your vehicle. Make sure the parking brake is set firmly, or your vehicle may roll if it is parked on an incline.

Set the parking brake before you put the transmission in Park. This keeps the vehicle from moving and putting pressure on the parking mechanism in the transmission.

Parking Tips

- Make sure the moonroof and the windows are closed.
 - Turn off the lights.
 - Place any packages, valuables, etc. in the cargo area or take them with you.
 - Lock the doors and the tailgate.
- Never park over dry leaves, tall grass, or other flammable materials. The hot three way catalytic converter could cause these materials to catch on fire.
 - If the vehicle is facing uphill, turn the front wheels away from the curb.
 - If the vehicle is facing downhill, turn the front wheels toward the curb.
 - Check the indicator on the instrument panel to verify that the security system is set.
 - Make sure the parking brake is fully released before driving away. Driving with the parking brake partially set can overheat or damage the rear brakes.

Tire Pressure Monitoring System (TPMS)

Your vehicle is equipped with a tire pressure monitoring system (TPMS) that turns on every time you start the engine and monitors the pressure in your tires while driving.

Each tire has its own pressure sensor. If the air pressure of a tire becomes significantly low, the sensor in that tire immediately sends a signal that causes the low tire pressure/TPMS indicator in the instrument panel to come on. If this happens, you will see which tire is losing pressure on the multi-information display along with a “CHECK TIRE PRESSURE” message.



Low Tire Pressure/ TPMS Indicator

When the low tire pressure/TPMS indicator is on, one or more of your tires is significantly underinflated. You should stop and check your tires as soon as possible, and inflate them to the proper pressure as indicated on the vehicle's tire information placard.

It is possible that the pressures shown on the multi-information display and the pressures you manually measure are slightly different.

If the difference is significant or you cannot make the low tire pressure/TPMS indicator and message on the multi-information display go out after inflating the tires to the specified values, have your dealer check the system as soon as possible.

If you think you can safely drive a short distance to a service station, proceed slowly to the station, then inflate the tire to the recommended pressure.

If the tire is flat, or if the tire pressure is too low to continue driving, replace the tire with the compact spare tire (see page 551).

Driving on a significantly underinflated tire causes the tire to overheat and can lead to tire failure. Under-inflation also reduces fuel efficiency and tire tread life, and may affect the vehicle's handling and stopping ability.

Because tire pressure varies by temperature and other conditions, the low tire pressure/TPMS indicator may come on unexpectedly.

CONTINUED

Tire Pressure Monitoring System (TPMS)

For example, if you check and fill your tires in a warm area, then drive in extremely cold weather, the tire pressure will be lower than measured and could be underinflated and cause the low tire pressure/TPMS indicator to come on. Or, if you check and adjust your tire pressure in cooler conditions, and drive into extremely hot conditions, the tire may become overinflated. However, the low tire pressure/TPMS indicator will not come on if the tires are overinflated.

Refer to page 540 for tire inflation guidelines.

If there is a problem with the TPMS, this indicator begins to flash. It stops flashing after approximately 1 minute, then stays on. You will also see a “CHECK TPMS SYSTEM” message on the multi-information display (see page 88).

Although your tire pressure is monitored, you must manually check the tire pressures monthly.

Each tire, including the spare, should be checked monthly when the vehicle is cold, and set to the recommended inflation pressure as specified on the vehicle placard and in the owner's manual (see page 541).

Tire Pressure Monitor



To select the tire pressure monitor, press the INFO button several times with the ignition switch in the ON (II) position.

You will see the above display on the multi-information display when all tire pressures are normal.

Tire Pressure Monitoring System (TPMS)

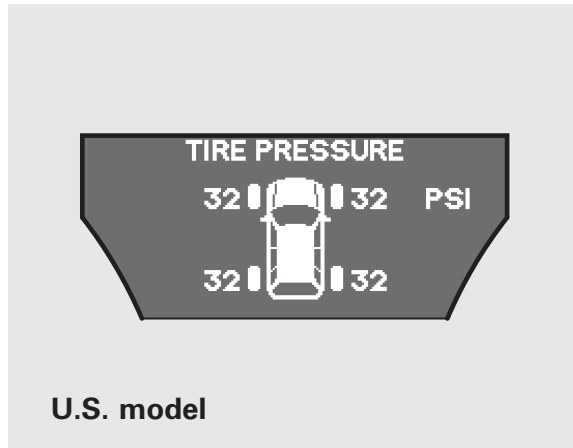

To see the inflation pressures of all four tires, press the SEL/RESET button. The display changes as shown above.

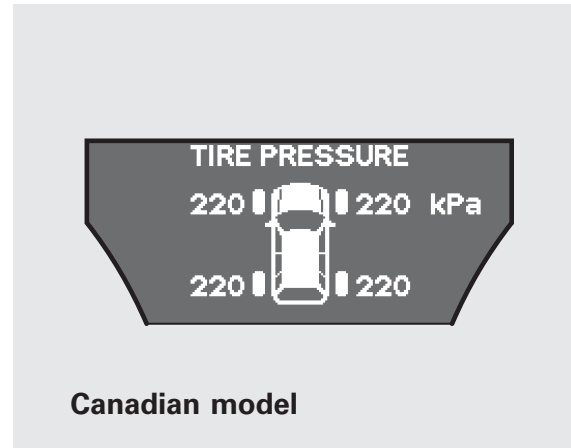

Each tire pressure is shown in PSI (U.S. models) or in kPa (Canadian models).



Each tire has its own pressure sensor. If the air pressure of a tire becomes significantly low, the sensor in that tire immediately sends a signal that causes the low tire pressure/TPMS indicator in the instrument panel to come on. If this happens, you will see which tire is losing pressure on the multi-information display along with a "CHECK TIRE PRESSURE" message.

Tire Pressure Monitoring System (TPMS)



If any of the tires has low pressure, the tire pressure monitor also shows the above message to warn you about the low tire pressure when you select the display by pressing the INFO button several times. Following this display, press the SEL/RESET button to see each tire pressure. When you continue driving after installing the spare tire, you will also see this message on the multi-information display.

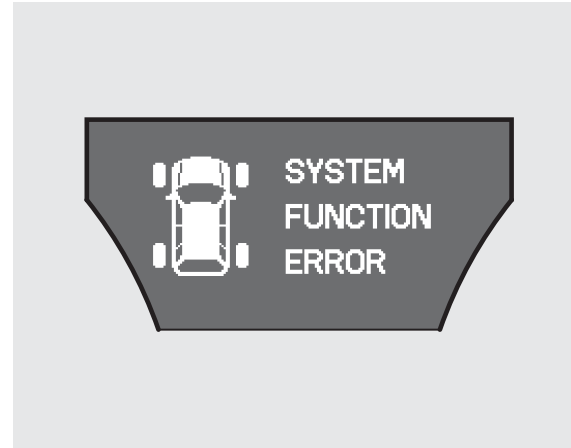

If there is a problem with the TPMS, the tire pressure monitor shows a "SYSTEM FUNCTION ERROR" message and the tire pressure readings are not displayed. If this happens, you will first see a system warning message "CHECK TPMS SYSTEM" on the multi-information display.

TPMS System Failure

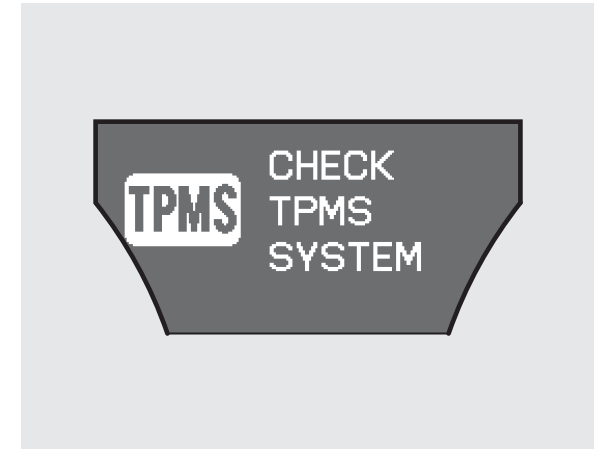

If there is a problem with the TPMS, you will see the above message on the multi-information display.

If you see this message, the system is off and is not monitoring the tire pressures. Have the system checked by your dealer as soon as possible.

Also, the low tire pressure/TPMS indicator begins to flash, then stays on (see page 455).

Tire Pressure Monitoring System (TPMS)

If the low tire pressure/TPMS indicator comes on, or the multi-information display shows a “CHECK TPMS SYSTEM” message, the VSA system automatically turns on even when the VSA system is turned off by pressing the VSA OFF button (see page 474). If this happens, you cannot turn the VSA system off by pressing the VSA OFF button again.

When you restart the vehicle with the compact spare tire, the TPMS system message will also be displayed on the multi-information display after several miles (kilometers) driving.

Changing a Tire with TPMS

If you have a flat tire, the low tire pressure/TPMS and tire monitor indicators will come on. Replace the indicated flat tire with the compact spare tire (see page 551).

After the flat tire is replaced with the spare tire, the low tire pressure/TPMS indicator stays on while driving. After several miles (kilometers) driving, this indicator begins to flash, then stays on again. You will also see a “CHECK TPMS SYSTEM” message on the multi-information display. This is normal; the system cannot monitor the spare tire pressure. Manually check the spare tire pressure to be sure it is correct.

This indicator and the warning message on the multi-information display will go off, after several miles (kilometers) driving, when the spare tire is replaced with the specified regular tire equipped with the tire pressure monitor sensor.

Each wheel is equipped with a tire pressure sensor. You must use TPMS specific wheels. It is recommended that you always have your tires serviced by your dealer or a qualified technician.

Never use a puncture-repairing agent in a flat tire. If used, you will have to replace the tire pressure sensor. Have the flat tire repaired by your dealer as soon as possible.

CONTINUED

Tire Pressure Monitoring System (TPMS), Braking System

As required by the FCC:

This device complies with Part 15 of the FCC rules. Operation is subject to the following two conditions: (1) This device may not cause harmful interference, and (2) this device must accept any interference received, including interference that may cause undesired operation.

Changes or modifications not expressly approved by the party responsible for compliance could void the user's authority to operate the equipment.

This device complies with Industry Canada Standard RSS-210.

Operation is subject to the following two conditions: (1) this device may not cause interference, and (2) this device must accept any interference that may cause undesired operation of the device.

Braking System

Your vehicle is equipped with disc brakes at all four wheels. A power assist helps reduce the effort needed on the brake pedal. The emergency brake assist system increases the stopping force when you depress the brake pedal hard in an emergency situation. The anti-lock brake system (ABS) helps you retain steering control when braking very hard.

Resting your foot on the pedal keeps the brakes applied lightly, builds up heat, and reduces their effectiveness and reduces brake pad life. In addition, fuel economy can be reduced. It also keeps your brake lights on all the time, confusing drivers behind you.

Constant application of the brakes when going down a long hill builds up heat and reduces their effectiveness. Use the engine to assist the brakes by taking your foot off the accelerator and downshifting to a lower gear.

Check the brakes after driving through deep water. Apply the brakes moderately to see if they feel normal. If not, apply them gently and frequently until they do. Be extra cautious in your driving.

Braking System Design

The hydraulic system that operates the brakes has two separate circuits. Each circuit works diagonally across the vehicle (the left-front brake is connected with the right-rear brake, etc.). If one circuit should develop a problem, you will still have braking at two wheels.

Brake Wear Indicators

All four brakes have audible brake wear indicators.

If the brake pads need replacing, you will hear a distinctive, metallic screeching sound when you apply the brake pedal. If you do not have the brake pads replaced, they will screech all the time. It is normal for the brakes to occasionally squeal or squeak when you apply them.

Anti-lock Brakes (ABS)

The anti-lock brake system (ABS) helps prevent the wheels from locking up, and helps you retain steering control by pumping the brakes rapidly, much faster than a person can do it.

The electronic brake distribution (EBD) system, which is part of the ABS, also balances the front-to-rear braking distribution according to vehicle loading.

You should never pump the brake pedal. Let the ABS work for you by always keeping firm, steady pressure on the brake pedal. This is sometimes referred to as “stomp and steer.”

You will feel a pulsation in the brake pedal when the ABS activates, and may hear some noise. This is normal: it is the ABS rapidly pumping the brakes. On dry pavement, you will need to press on the brake pedal very hard before the ABS activates. However, you may feel the ABS activate immediately if you are trying to stop on snow or ice.

CONTINUED

Anti-lock Brakes (ABS)



ABS Indicator

If this indicator comes on, the anti-lock function of the braking system has shut down. The brakes still work like a conventional system, but without anti-lock. You should have your dealer inspect your vehicle as soon as possible.

You will also see a “CHECK ABS SYSTEM” message on the multi-information display (see page 88).

If the indicator comes on while driving, test the brakes as instructed on page 564.

If the ABS indicator and the brake system indicator come on together, and the parking brake is fully released, the EBD system may also be shut down.

Test your brakes as instructed on page 564. If the brakes feel normal, drive slowly and have your vehicle repaired by your dealer as soon as possible. Avoid sudden hard braking which could cause the rear wheels to lock up and possibly lead to a loss of control.

Important Safety Reminders
ABS does not reduce the time or distance it takes to stop the vehicle. It only helps with steering control during braking.

ABS will not prevent a skid that results from changing direction abruptly, such as trying to take a corner too fast or making a sudden lane change. Always drive at a safe speed for the road and weather conditions.

ABS cannot prevent a loss of stability. Always steer moderately when you are braking hard. Severe or sharp steering wheel movement can still cause your vehicle to veer into oncoming traffic or off the road.

A vehicle with ABS may require a longer distance to stop on loose or uneven surfaces, such as gravel or snow, than a vehicle without anti-lock.

Collision Mitigation Braking System™ (CMBS™)

Overview

If equipped

The collision Mitigation braking system™ (CMBS™) can assist the driver when there is a possibility of colliding with the vehicle in front of yours. It is designed to reduce the speed of your vehicle before an unavoidable collision occurs and, if possible, to alert you to a potential collision while there is time for the driver to prevent it. Here is a brief description of what the CMBS can do:

When your speed is above 10 mph (15 km/h), the CMBS is monitoring the vehicle ahead of you with radar. When your vehicle is approaching the vehicle ahead of yours too quickly, the system may activate one or more of the following: a visual alert, an audible alert, apply the brakes and e-pretensioners to tighten the front seat belts - first as a warning, then to prepare for an impending crash. (see page 24).

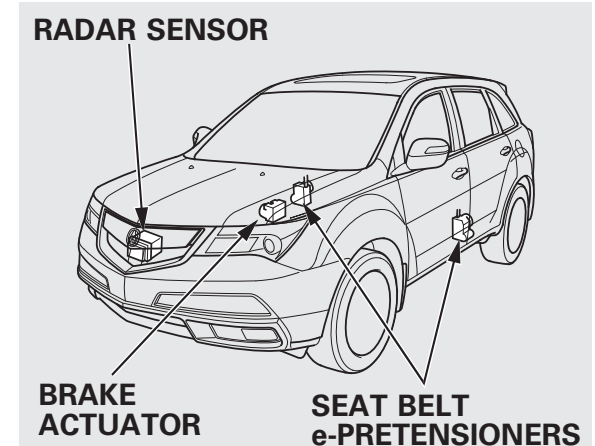

The CMBS consists of a radar sensor in the front grille, a brake actuator in the engine compartment, an indicator on the instrument panel, seat belt e-pretensioners on the front seats, and an on/off button on the dashboard.

Driving

CONTINUED

Collision Mitigation Braking System™ (CMBS™)

Radar Sensor

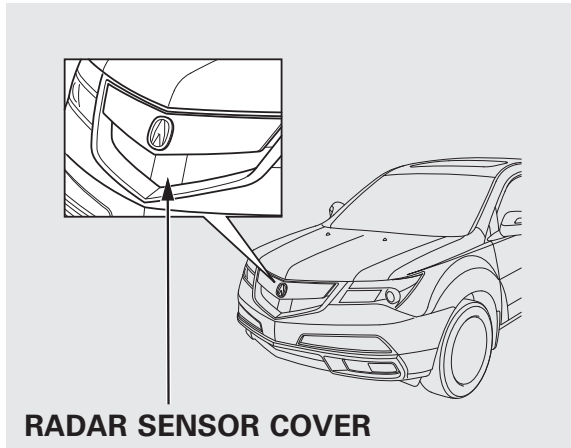

The radar sensor is located under the Acura emblem in the front grille. If the radar sensor cover is covered with mud, dirt, dead leaves, wet snow, etc., or if you put a sticker on it, the CMBS will automatically shut off, and the CMBS indicator on the instrument panel will come on. You will also see a “CHECK CMBS RADAR SENSOR” message on the multi-information display for about 5 seconds.

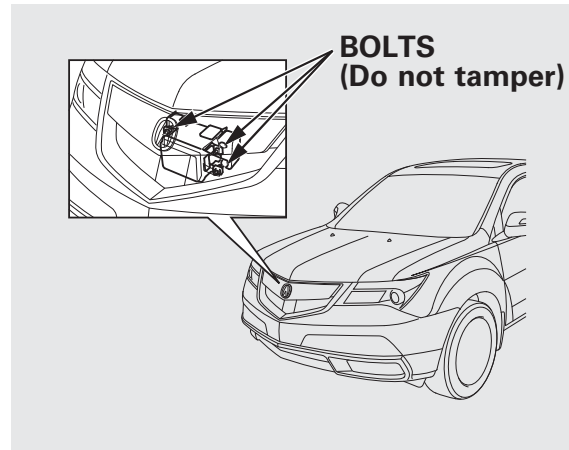

Always keep the radar sensor cover clean. If it gets dirty, clean it with water or a mild detergent. Never use chemical solvents or polishing powder.

There are three bolts on the sides of the radar sensor. Do not tamper with these bolts, or you may cause the system to malfunction.

Do not allow anything to impact the radar sensor or the radar sensor cover. If either of these parts receives a strong impact, switch the system off by pressing the CMBS off button, and have your vehicle checked by a dealer. If the front grille ever needs to be repaired, consult a dealer first.

If the radar sensor cover or the radar sensor ever needs to be removed, take your vehicle to a dealer.

NOTICE

When the CMBS is on, the radar sensor constantly scans for vehicles directly ahead of you. This means that driving on a road with a few or no vehicles could cause a CHECK CMBS RADAR SENSOR message to appear on the multi-information display. This is normal and not a cause for concern.

Certain conditions may cause the radar aim to be temporarily out of proper range, such as the following two examples:

- Your vehicle is tilted because of a heavy load in the rear or from modifications to the suspension. Do not overload your vehicle (see Carrying Cargo on page 433), and do not make any modifications to the suspension (see Accessories and Modifications on page 431).
- The tires are not correctly maintained. Always make sure the tire pressures are correct (see page 540), and that the tires are the correct size and in good condition (see Tires on page 540).

Collision Alert

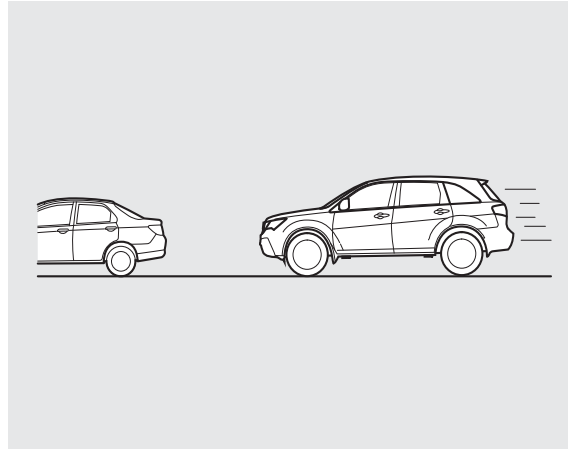



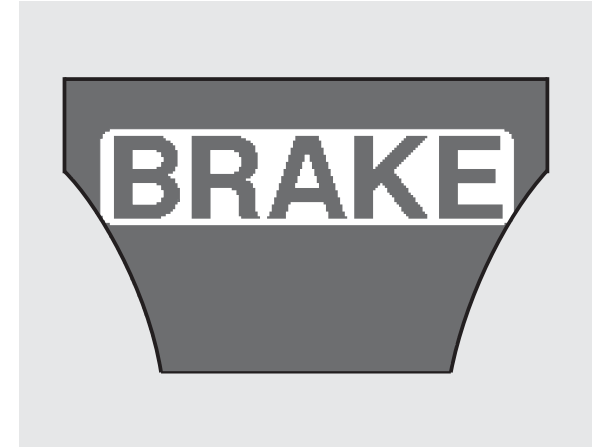

If the system senses a likely collision with a vehicle or object ahead of you, it alerts you with a visual alert or a combination of a visual alert and an audible alert.

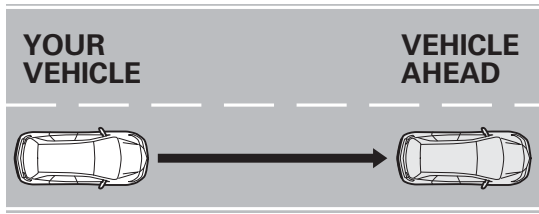
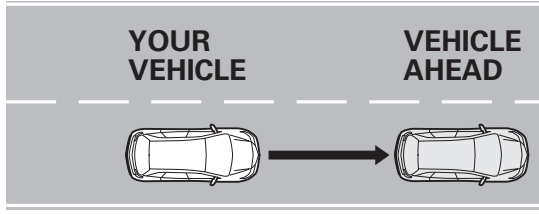

The visual alert is an amber colored BRAKE message that flashes on the multi-information display, the audible alert is a constant beeping sound. If one or more of the alerts come on, take the appropriate means to prevent a collision (apply the brakes, change lanes, etc.).

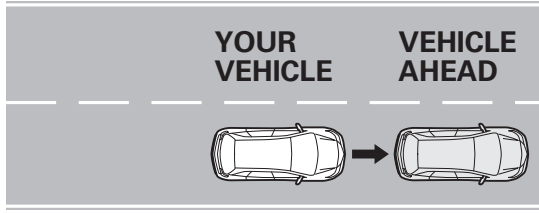
Collision Mitigation Braking System™ (CMBS™)

Distance between vehicles		CMBS			
		The radar sensor detects a vehicle	E-pretensioner	Audio & Visual WARNINGS	Braking
Stage one		There is a risk of a collision with the vehicle ahead of you.	—	“BRAKE” flashes on the multi-information display.	—
Stage two		The risk of a collision has increased, time to respond is reduced.	Retracts the driver's seat belt gently a few times, providing a physical warning. 	A beep sounds and “BRAKE” flashes on the multi-information display.	Lightly applied
Stage three*		The CMBS determines that a collision is unavoidable.	Forcefully tightens driver and front passenger seat belts. 		Forcefully applied

*: Depending on the circumstances, CMBS may not go through all of the alert stages before initiating the last stage.

CMBS OFF Button

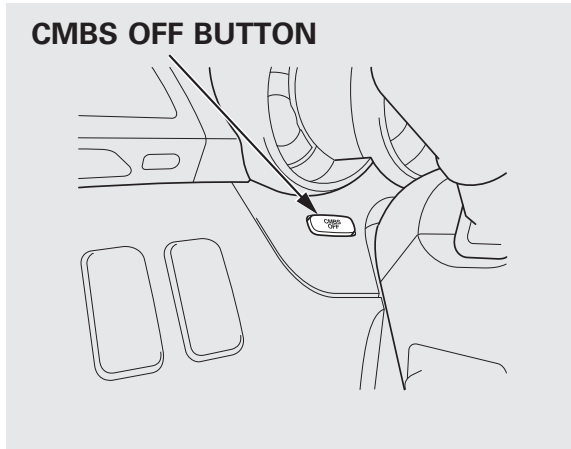

To switch the CMBS off, press the CMBS OFF button on the dashboard for about 1 second. When you do this, a beeper sounds, a CMBS indicator on the instrument panel comes on, and a CMBS OFF message appears on the multi-information display. To switch the system back on, press the button again for about 1 second.

When you turn the ignition switch to the ON (II) position, the CMBS will be in the previously selected on or off setting.

Automatic Shut Off

Any of the conditions below can cause the CMBS to shut off. When the system shuts off, the CMBS indicator in the instrument panel comes on, and a CHECK CMBS SYSTEM message appears on the multi-information display for about 5 seconds.

- An abnormal tire condition is detected (wrong tire size, flat tire, etc.).
- Extended off-road or mountainous driving.
- Driving your vehicle with the parking brake applied.
- Driving your vehicle in bad weather (rain, fog, snow, etc.).
- A dirty radar sensor cover on the front grille.

CONTINUED

Collision Mitigation Braking System™ (CMBS™)

The CMBS will automatically switch on again if the conditions that caused it to switch off are improved.

CMBS Indicator

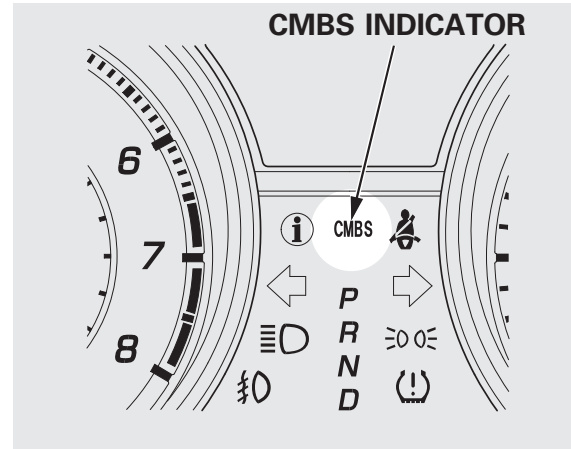

This indicator comes on for several seconds when you turn the ignition switch to the ON (II) position. It also comes on and stays on when you turn the CMBS off by pressing the CMBS OFF button.

To switch the CMBS back on, make sure the vehicle is stopped and the ignition switch is in the ON (II) position, then press the CMBS OFF button for about 1 second.

The CMBS indicator normally comes on under these conditions:

- When you manually switch off the system.
- When the system shuts off automatically.
- When you drive in bad weather (rain, snow, fog, etc.).
- If anything covers the radar sensor cover (dirt, mud, dry leaves, wet snow, etc.).

Collision Mitigation Braking System™ (CMBS™)

- When the VSA system indicator comes on (see page 473).
- When you turn the ignition switch to the ON (II) position, the CMBS indicator should come on for a few seconds, then go off. If the indicator comes on at any other time and a CHECK CMBS SYSTEM message appears on the multi-information display, there is a problem with the CMBS. You can still drive your vehicle, but CMBS will not be operating. Have your vehicle checked by a dealer.

Limitations

The CMBS may not activate under some conditions. Here are a few examples:

- The distance between your vehicle and the vehicle ahead of you is too short.
- A vehicle cuts in front of you at a slow speed, or it brakes suddenly.

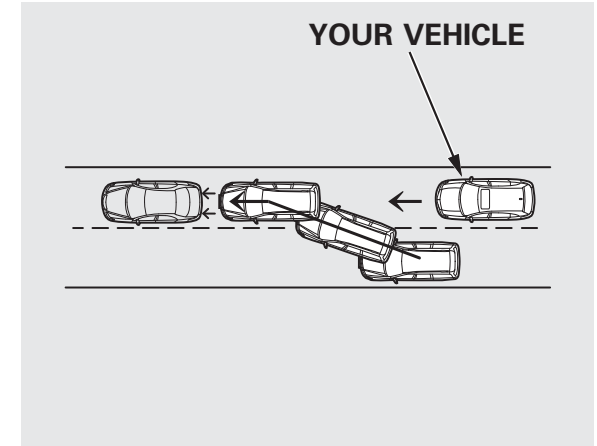

- When you accelerate rapidly and approach the vehicle ahead of you at high speed.
- Immediately after you begin driving.

Collision Mitigation Braking System™ (CMBS™)

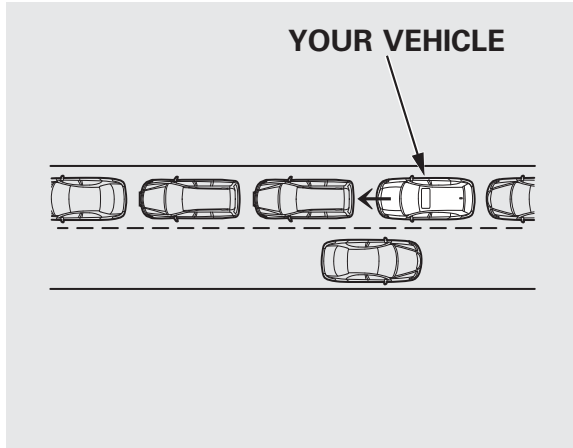

- Driving in heavy, stop-and-go traffic.
- The vehicle ahead of you is a motorcycle or other small vehicle.

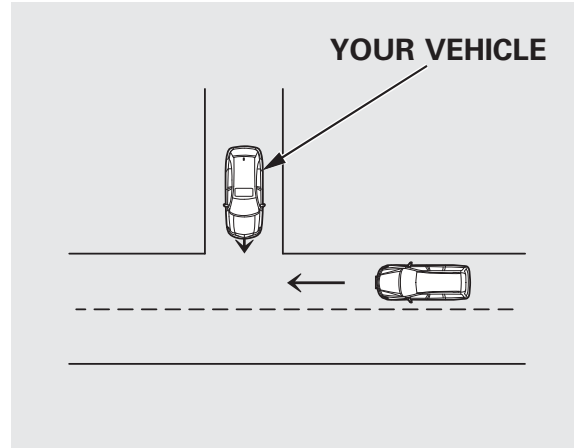

- A vehicle suddenly crosses in front of you.

NOTICE

The CMBS is not designed to detect pedestrians.

This system is designed to detect and provide sufficient advanced warning of a collision. As a result, you may experience occasional false activations.

Even with little or no chance of a collision, the CMBS may activate under these conditions:

- When you change lanes quickly, and go around the vehicle ahead of you.

Collision Mitigation Braking System™ (CMBS™)

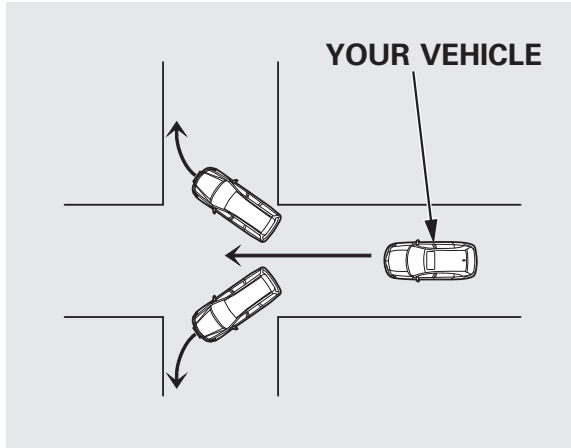

- When you approach or pass a vehicle ahead of you that is turning left or right in an intersection.

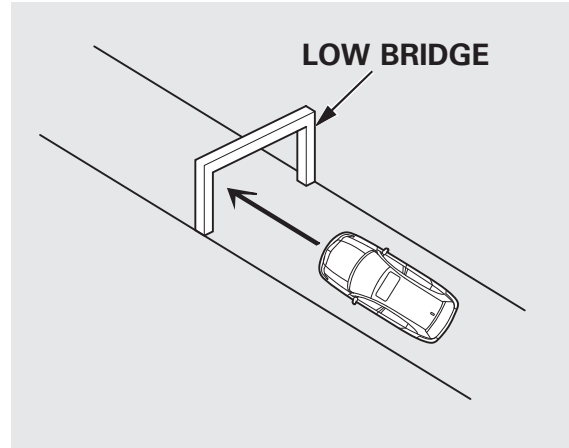

- When you pass a low bridge at high speed.
- When you go over a sharp-edged speed bump at high speed.
- When you go over areas of construction on the road surface.

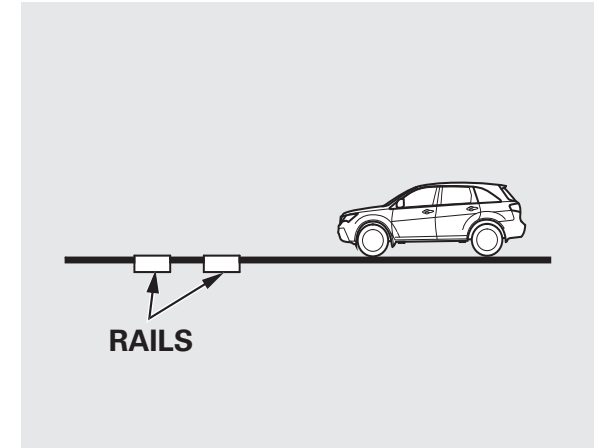

- When you approach train tracks.

Collision Mitigation Braking System™ (CMBS™)

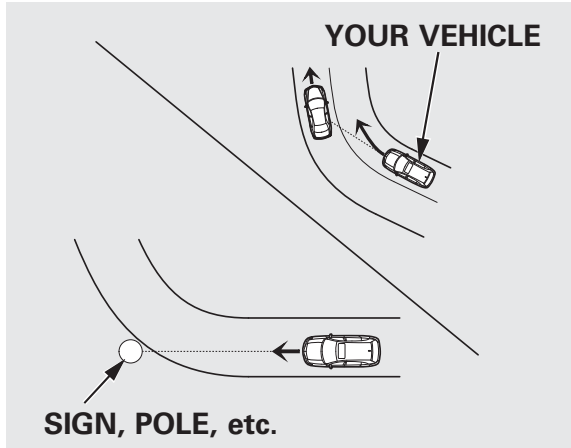

Because of the road condition (curved, winding, etc.) or the state of your vehicle (turning angle, lane position, etc.), CMBS can sometimes mistake a stationary object (light pole, traffic sign, guard rail, etc.) as a vehicle ahead of you and temporarily operate. This is normal.

Important Safety Reminder

The main purpose of the CMBS is to reduce the severity of injuries caused by an unavoidable collision. While the CMBS may help to alert you and minimize the severity of a collision, it may not activate in every dangerous situation.

Even with the CMBS, it is still your responsibility to operate the brake pedal and steering wheel appropriately, according to the driving conditions.

As required by the FCC:

This device complies with Part 15 of the FCC rules. Operation is subject to the following two conditions: (1) This device may not cause harmful interference, and (2) this device must accept any interference received, including interference that may cause undesired operation.

Changes or modifications not expressly approved by the party responsible for compliance could void the user's authority to operate the equipment.

This device complies with Industry Canada Standard RSS-210.

Operation is subject to the following two conditions: (1) this device may not cause interference, and (2) this device must accept any interference that may cause undesired operation of the device.

Vehicle Stability Assist (VSA®), aka Electronic Stability Control (ESC), System

The vehicle stability assist (VSA) system helps to stabilize the vehicle during cornering if the vehicle turns more or less than desired. It also assists you in maintaining traction while accelerating on loose or slippery road surfaces. It does this by regulating the engine's output and by selectively applying the brakes.

When VSA activates, you may notice that the engine does not respond to the accelerator in the same way it does at other times. There may also be some noise from the VSA hydraulic system. You will also see the VSA system indicator blink.

The VSA system cannot enhance the vehicle's driving stability in all situations and does not control your vehicle's entire braking system. It is still your responsibility to drive and corner at reasonable speeds and to leave a sufficient margin of safety.



VSA Off Indicator

When VSA is off, the VSA off indicator comes on as reminder.



Vehicle Stability Assist (VSA) System Indicator

When VSA activates, you will see the VSA system indicator blink.

If this indicator comes on while driving, pull to the side of the road when it is safe, and turn off the engine. Reset the system by restarting the engine. If the VSA system indicator stays on or comes back on while driving, have the VSA system inspected by your dealer.

NOTE: The main function of the VSA system is generally known as Electronic Stability Control (ESC). The system also includes a traction control function.

If the indicator does not come on when the ignition switch is turned to the ON (II) position, there may be a problem with the VSA system. Have your dealer inspect your vehicle as soon as possible.

CONTINUED

Vehicle Stability Assist (VSA®), aka Electronic Stability Control (ESC), System

You will also see a “CHECK VSA SYSTEM” message on the multi-information display if there is a problem with the VSA system.

If the low tire pressure/TPMS indicator comes on, or the multi-information display shows a “CHECK TPMS SYSTEM” message with the indicator flashing (see page 458), the VSA system automatically turns on even if the VSA system is turned off by pressing the VSA OFF button. If this case, you cannot turn the VSA system off by pressing the VSA OFF button again.

Without VSA, your vehicle will have normal braking and cornering ability, but it will not have VSA traction and stability enhancement.

VSA Off Button

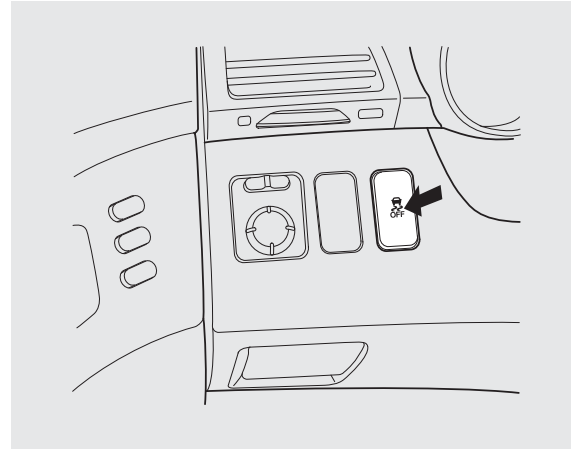

This switch is under the driver's side vent. To turn the VSA system on and off, press and hold it until you hear a beep.

When VSA is off, the VSA off indicator comes on as a reminder. Press and hold the switch again. It turns the system back on. With the VSA off, the trailer stability assist function is also turned off (see page 498).

VSA is turned on every time you start the engine, even if you turned it off the last time you drove the vehicle.

In certain unusual conditions when your vehicle gets stuck in shallow mud or fresh snow, it may be easier to free it with the VSA temporarily switched off. When the VSA system is off, the traction control system is also off. You should only attempt to free your vehicle with the VSA off if you are not able to free it when the VSA is on.

Immediately after freeing your vehicle, be sure to switch the VSA on again. We do not recommend driving your vehicle with the VSA and traction control systems switched off.

Vehicle Stability Assist (VSA®), aka Electronic Stability Control (ESC), System

VSA and Tire Sizes

Driving with varying tire or wheel sizes may cause the VSA to malfunction. When replacing tires, make sure they are of the same size and type as your original tires (see page 545).

If you install winter tires, make sure they are the same size as those that were originally supplied with your vehicle. Exercise the same caution during winter driving as you would if your vehicle was not equipped with VSA.

Hill Start Assist

Your vehicle is equipped with a hill start assist feature to help prevent the vehicle from rolling on steep inclines as you move your foot from the brake pedal to the accelerator.

This feature starts operating a few seconds after you are in any drive gear position (when faced uphill) or in reverse (when faced downhill). This feature requires that the vehicle has come to a complete stop before it can work.

Hill start assist may not hold a heavily loaded vehicle, such as when your vehicle is connected to a trailer, or prevent your vehicle from rolling downhill on a very steep or slippery slope.

Blind Spot Information System (BSI)

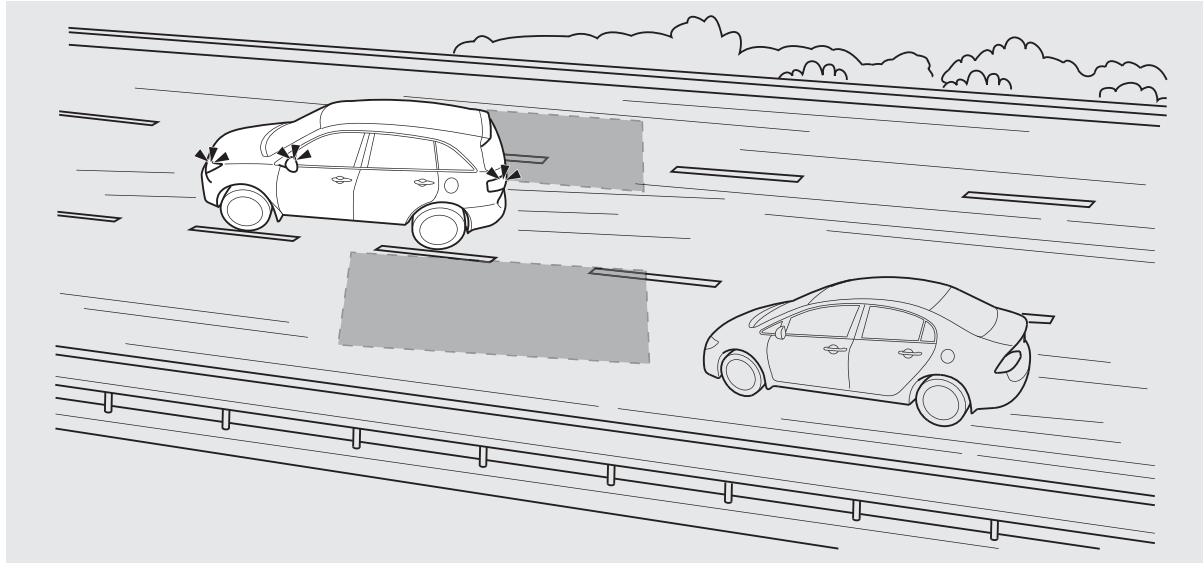

If equipped
The blind spot information system (BSI) is designed to assist you when you are changing lanes.

If the system detects vehicles in adjacent lanes, it automatically illuminates the appropriate indicator to provide assistance when you change lanes. It is not a substitute for visual confirmation that it is safe to change lanes.

⚠ WARNING

Failure to visually confirm that it is safe to change lanes before doing so may result in a crash and serious injury or death. Do not rely only on the blind spot information system when changing lanes.

Always look in your mirrors, to either side of your vehicle, and behind you for other vehicles before changing lanes.

BSI Operation

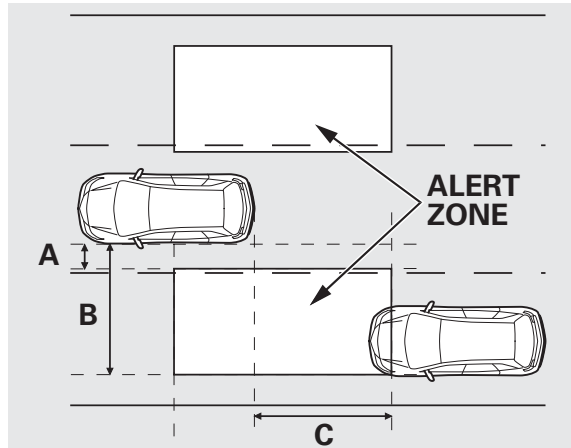

A: Approximately 1.6 ft. (0.5m)

B: Approximately 10 ft. (3m)

C: Approximately 10 ft. (3m)

BSI is designed to detect vehicles in specified alert zones adjacent to your vehicle, particularly in harder to see areas commonly known as “blind spots.”

When BSI detects a vehicle in an alert zone, a BSI alert indicator comes on near the corresponding outside rearview mirror.

While your vehicle is moving forward at a speed between 6 mph (10 km/h) and 100 mph (160 km/h), the BSI alert indicator comes on under either of the following conditions:

- Another vehicle overtakes you, entering the alert zone from behind, at a speed that differs from your vehicle's speed by no more than 31 mph (50 km/h).
- You pass a vehicle at a speed that differs from that vehicle's speed by no more than 12 mph (20 km/h). The indicator comes on approximately 2 seconds after the vehicle enters the alert zone.

The system will not alert you to all vehicles in blind spot zones (such as vehicles you have just passed which you should already be aware of) unless it remains in the alert zone for approximately 2 or more seconds.

While the system is on, BSI is active whenever the shift lever is in the D or S position.

CONTINUED

Blind Spot Information System (BSI)

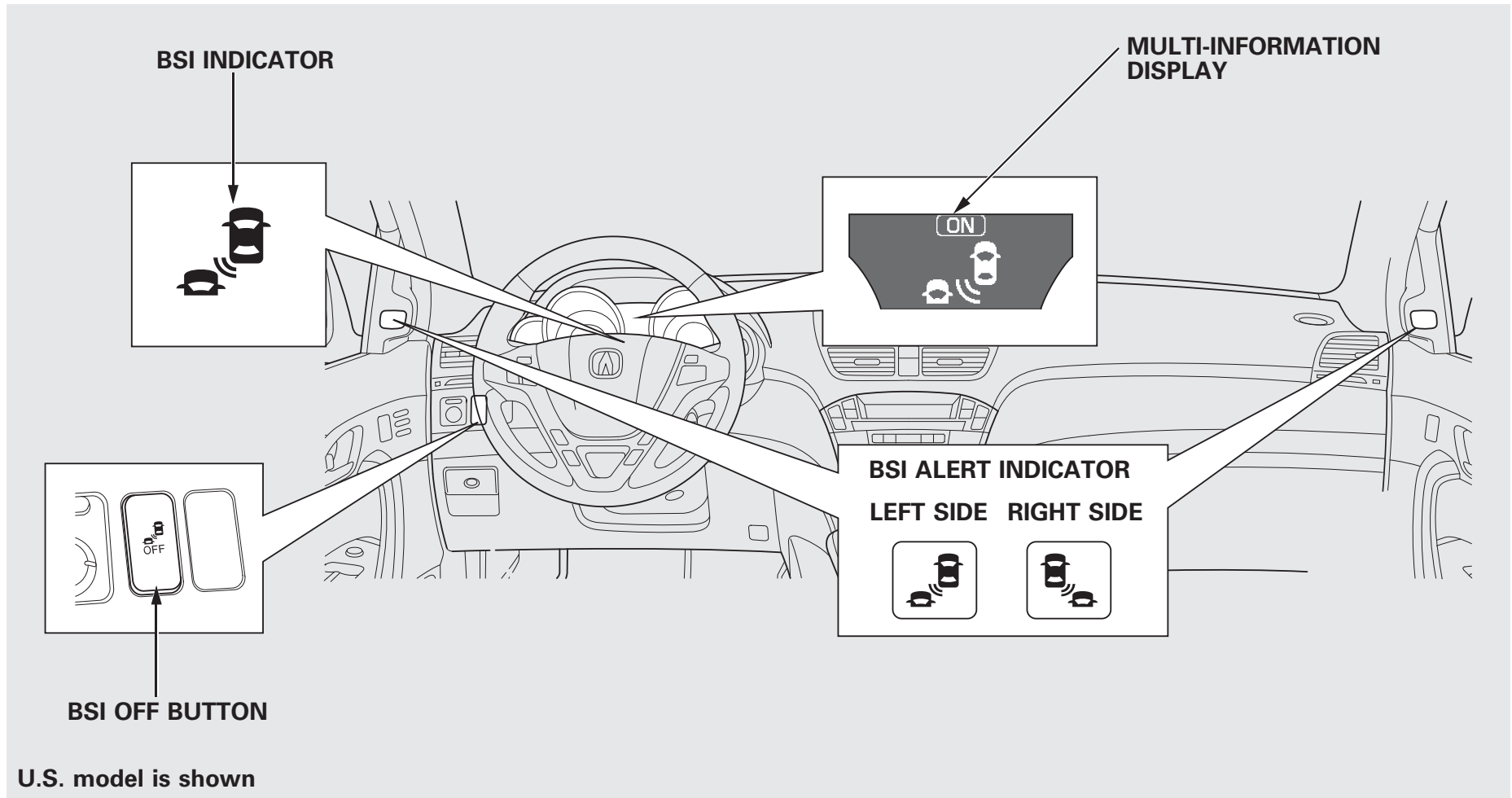

Blind Spot Information System (BSI)

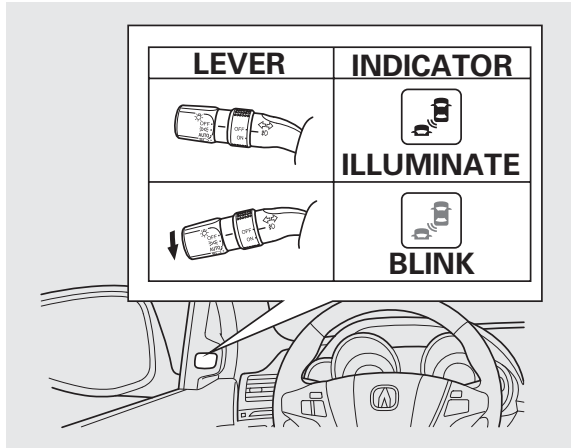

The BSI alert indicator starts to blink as a reminder if you move the turn signal lever in the direction of the detected vehicle.

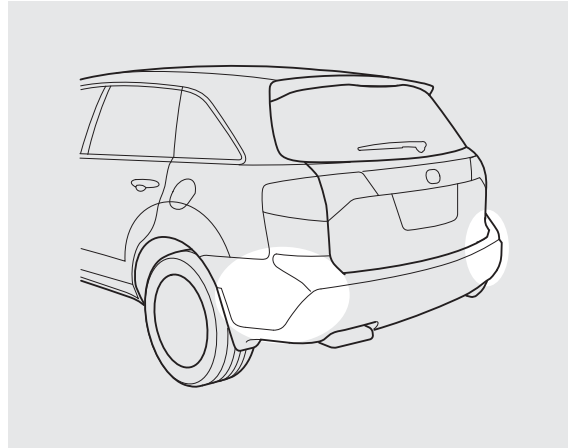

Radar sensors, located underneath each corner of the rear bumper, detect objects. Do not cover this area with labels or stickers of any kind. Always keep this area is free of any kind of dirt every time you get in the vehicle.

Impacts to the radar sensors or the area around them can affect system performance. If an impact occurs, have the system checked by your dealer.

Blind Spot Information System (BSI)

Important Precautions

Like all assistance systems, BSI has limitations. Over-reliance on BSI may result in a collision. Always look in your mirrors, to either side of your vehicle, and behind you for other vehicles before changing lanes.

The system should be turned off when towing a trailer. Due to the added mass and resulting changes in radar coverage, the system cannot operate as intended, and detection of the trailer itself by the radar sensors may cause the BSI alert indicators to illuminate.

Limitations

The BSI alert indicators may not illuminate under the following circumstances:

- The speed difference between your vehicle and a vehicle approaching from behind is greater than 31 mph (50 km/h).
- A vehicle is parked in a side lane.
- The speed difference between your vehicle and the vehicle you are passing is greater than 6 mph (10 km/h).
- An object not detected by the radar sensors approaches or passes your vehicle.

Blind Spot Information System (BSI)

BSI may be adversely affected under the following circumstances:

- When objects such as guard rails, poles, trees, etc., are detected.
- When an object that doesn't reflect radio waves well, such as a motorcycle, is in the alert zone.
- A vehicle is behind or approaching your vehicle while on a curved road.
- When towing a trailer.
- A vehicle is moving from a far lane to the adjacent lane.
- The system picks up external electrical interference.
- The rear bumper has been deformed, or improperly repaired.

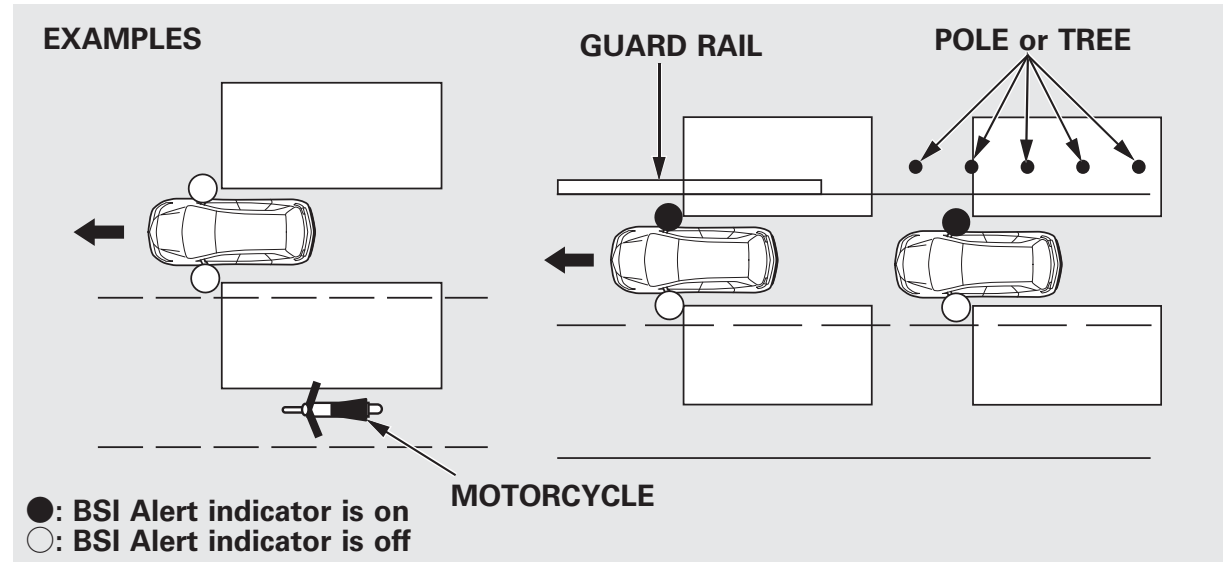

- The orientation of the sensors has been changed.
- Bad weather conditions, such as heavy rain, snow and fog.

The system is for your convenience. Even if an object is within the alert zone, the system may not detect it, depending on its shape. Always look in your mirrors, to either side of your vehicle, and behind you for other vehicles before changing lanes.

Blind Spot Information System (BSI)

BSI OFF Button

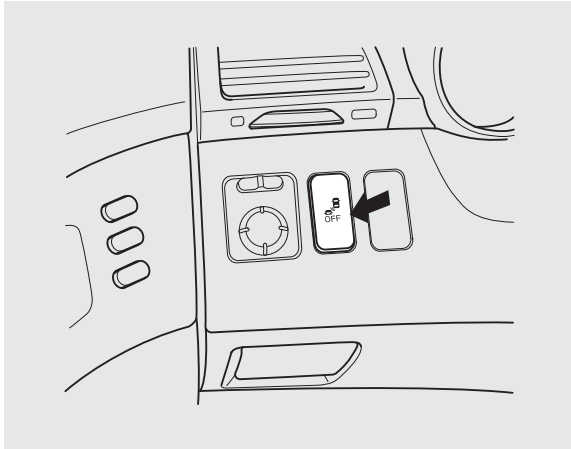







To turn the system off, press the BSI OFF button when the ignition switch is in the ON (II) position. The BSI indicator on the instrument panel glows amber, indicating that the system is turned off. The multi-information display indicates that the system is off.

To turn the system on again, press the same button. The BSI indicator on the instrument panel turns off. The multi-information display indicates that the system is on.

When the ignition switch is turned to the ON (II) position, the system will be in the previously selected ON or OFF setting.

Blind Spot Information System (BSI)

BSI Status Displays

System Status	Multi-information display message	BSI Indicator	Description
ON		—	When you push the BSI OFF button, a BSI ON or OFF message is displayed on the multi-information display for about 5 seconds. The BSI indicator will remain on while the system is off. A chime sounds to indicate that the system has been turned ON or OFF.
OFF			
ON/OFF*			<p>If while driving, mud, snow, or ice accumulates in the vicinity of sensor:</p> <ul style="list-style-type: none"> • The system may shut down • The BSI indicator illuminates, a message is displayed on the multi-information display, and a chime sounds. <p>The BSI indicator will turn off and the system will return to normal once the obstacle is removed, and you begin to drive. Always keep the area around the radar sensors clean. BSI may not operate properly if the sensors are obstructed.</p> <p>The BSI alert indicator:</p> <ul style="list-style-type: none"> • May come on when a vehicle enters one of the alert zones, even if this message is displayed. • May not come on due to obstruction (splashes, etc.), even if this message is not displayed. <p>*: System status may remain on even when the BLIND SPOT NOT AVAILABLE message is displayed.</p>
OFF			If the system is faulty, the BSI indicator illuminates and a message is displayed on the multi-information display. Have your vehicle inspected by your Acura dealer.

CONTINUED

Blind Spot Information System (BSI), Active Damper System

As required by the FCC:

This device complies with Part 15 of the FCC rules. Operation is subject to the following two conditions: (1) This device may not cause harmful interference, and (2) this device must accept any interference received, including interference that may cause undesired operation.

Changes or modifications not expressly approved by the party responsible for compliance could void the user's authority to operate the equipment.

This device complies with Industry Canada Standard RSS-210.

Operation is subject to the following two conditions: (1) this device may not cause interference, and (2) this device must accept any interference that may cause undesired operation of the device.

Active Damper System

If equipped

The active damper system is always on, constantly adjusting your vehicle's dampers to the best settings for current road conditions along with vehicle speed and handling inputs.

The system uses electrically controlled dampers to enhance handling precision, vehicle composure, tire to road adhesion and rough road ride comfort isolation. The system reacts to inputs from various electronic sensors to give exactly the right amount of suspension damping to provide optimal ride comfort and handling.

The system provides two selectable modes.

Sport mode: The system prioritizes handling response, vehicle body control and tire-to-road adhesion to allow for higher performance handling.

Comfort mode: The system prioritizes road isolation to allow for a more comfortable ride.

Either mode can be used in any type of operating conditions, but the mode may change temporarily to suit a change in road surface.

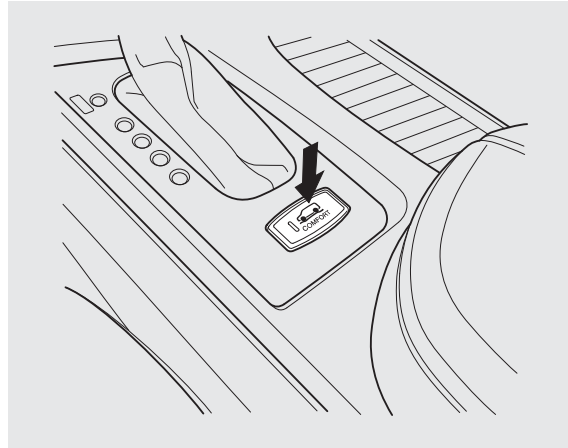

To switch between comfort and sport mode, press and release the active damper system button located on the center console to choose the desired mode.

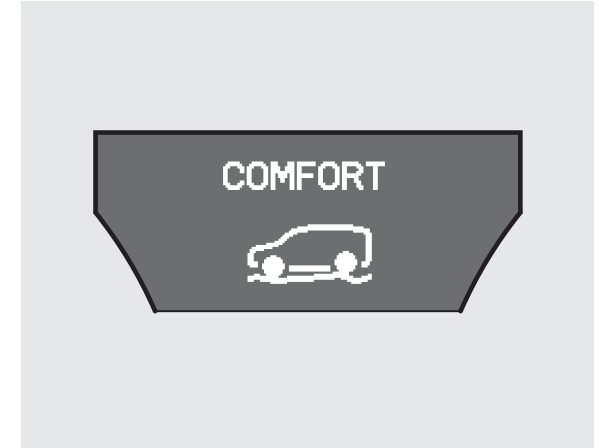

When comfort mode is selected, the green indicator in the button comes on, and the message “COMFORT” will appear on the multi-information display for five seconds.

CONTINUED

Active Damper System

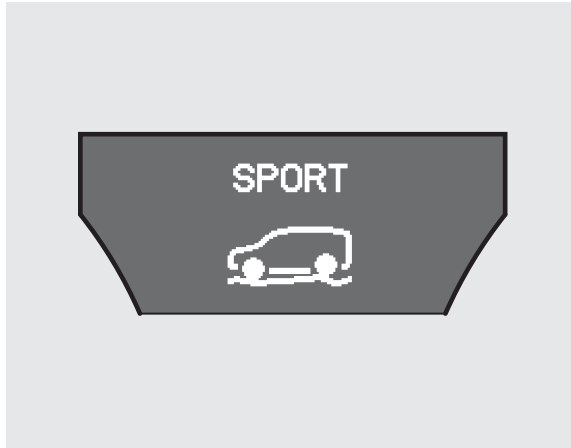

When sport mode is selected, the green indicator in the button goes off, and the message “SPORT” will appear on the multi-information display for five seconds.



Active Damper System Indicator

If there is a problem with the active damper system, the active damper system shuts down and the active damper system indicator on the instrument panel comes on.

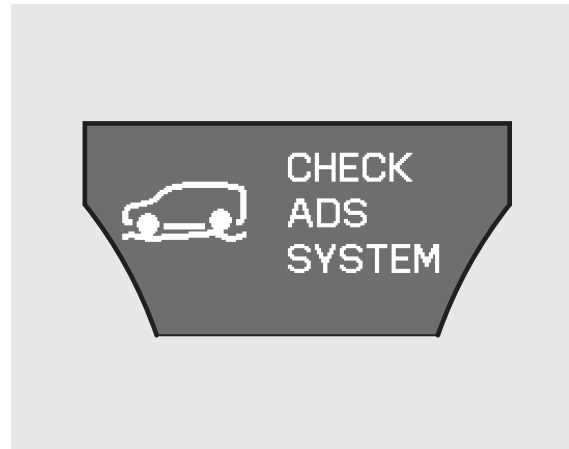

You will also see the “CHECK ADS SYSTEM” message appear on the multi-information display.

If you see this warning indicator and message, have your vehicle checked at your dealer as soon as possible.

In this case, your vehicle still has the normal damper function, but it will not have the active damper function.

Your vehicle has been designed primarily to carry passengers and their cargo. You can also use it to tow a trailer if you carefully observe the load limits, use the proper equipment, and follow the guidelines in this section.

If your vehicle is equipped with the blind spot information system (BSI), do not use it when towing a trailer. For more information see page 482.

Break-In Period

Avoid towing a trailer during your vehicle's first 600 miles (1,000 km) (see page 422).

Be sure to read the **Off-Highway Driving Guidelines** section on page 500 if you plan to tow off paved surfaces.

Your vehicle is equipped with a trailer stability assist to help stabilize the vehicle/trailer combination by reducing the vehicle speed. For more information, see page 498.

⚠ WARNING

Exceeding any load limit or improperly loading your vehicle and trailer can cause a crash in which you can be seriously hurt or killed.

Check the loading of your vehicle and trailer carefully before starting to drive.

Load Limit



Total Trailer Weight

The maximum allowable weight of the trailer and everything in or on it depends on the number of occupants in your vehicle and the type of trailer being towed (see page 490).

Towing a trailer that is too heavy can seriously affect your vehicle's handling and performance. It can also damage the engine and drivetrain.

CONTINUED

Towing a Trailer

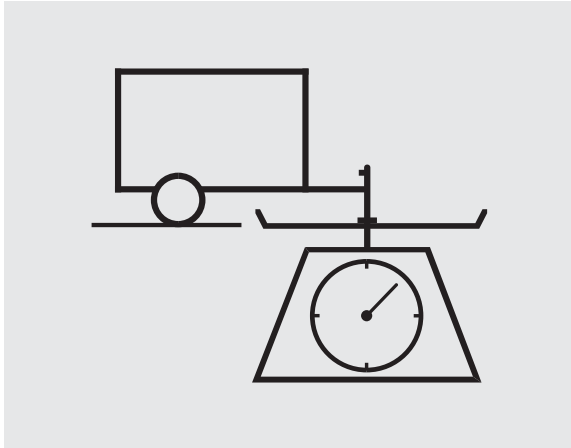

Tongue Load

The weight that the tongue of a fully loaded trailer puts on the hitch should be 5 to 15 percent of the total trailer weight for boat trailers, and 8 to 15 percent of total trailer weight for all other trailers. (See page 490 for limits for your towing situation). Too much tongue load reduces front-tire traction and steering control. Too little tongue load can make the trailer unstable and cause it to sway.

Gross Vehicle Weight Rating

(GVWR) – The maximum allowable weight of the vehicle, all occupants, all accessories, all cargo and the tongue load is 5,952 lbs (2,700 kg).

Gross Axle Weight Ratings

(GAWR) – The maximum allowable weight of the vehicle, all occupants, all accessories, all cargo, and the tongue load must not exceed 2,888 lbs (1,310 kg) on the front axle, and 3,175 lbs (1,440 kg) on the rear axle.

Gross Combined Weight Rating

(GCWR) – The maximum allowable weight of the fully loaded vehicle and trailer is 10,053 lbs (4,560 kg) with the proper hitch. The GCWR must be reduced 2 percent for every 1,000 feet (305 meters) of elevation.

Estimating Loads

The best way to confirm that all loads are within limits is to check them at a public scale. For public scales in your area, check your local phone book, or contact your trailer dealer or rental agency for assistance.

To help ensure a safe drive to a scale, or if you cannot get to a public scale, we recommend that you estimate your total trailer weight and tongue load as described.

To Estimate the Total Trailer Weight

Add the weight of your trailer (as quoted by the manufacturer) with everything in or on the trailer. Then check the tables on page 490 to make sure you do not exceed the limit for your conditions.

To Estimate the Tongue Load

1. Park the vehicle on level ground.
2. Measure and record the distance from the ground to the bottom of the trailer hitch.
3. Connect the fully loaded trailer to the hitch.
4. Measure again from the ground to the same spot on the bottom of the hitch.
5. Subtract the second measurement from the first measurement, then refer to the following table.

On models without Active Damper System

If the difference is:	Estimated tongue load is:
13/32"	150 lbs (68 kg)
11/16"	250 lbs (114 kg)
31/32"	350 lbs (159 kg)
1 1/4"	450 lbs (205 kg)

On models with Active Damper System

If the difference is:	Estimated tongue load is:
1/2"	150 lbs (68 kg)
27/32"	250 lbs (114 kg)
1 5/32"	350 lbs (159 kg)
1 1/2"	450 lbs (205 kg)

If the difference is more than 1 1/2 inch, you have too much load on the tongue. Redistribute the load or remove cargo as needed.

CONTINUED

Towing a Trailer

Total Trailer Weight and Tongue Load Limits:

Number of Occupants*	Maximum Total Trailer Weight	Maximum Tongue Load**
2	5,000 lbs (2,268 kg)	500 lbs (227 kg)
3	4,751 lbs (2,155 kg)	470 lbs (213 kg)
4	4,500 lbs (2,041 kg)	370 lbs (168 kg)
5	4,250 lbs (1,928 kg)	276 lbs (125 kg)
6	3,999 lbs (1,814 kg)	150 lbs (68 kg)
7	Towing is Not Recommended	

* The corresponding weight limits assume occupants fill seats from the front of the vehicle to the back, each occupant weighs 150 lbs (68 kg), and each has 15 lbs (7 kg) of cargo in the cargo area. Any additional weight, including cargo or accessories, reduces the maximum trailer weight and maximum tongue load. Never exceed the gross axle weight ratings (see page 487).

** Recommended tongue load should be 5 — 15% of the total trailer weight for boat trailers, and 8 — 15% of the total trailer weight for all other trailers.

Checking Loads

To accurately check your loads at the public scale, the vehicle and trailer should be fully loaded, and all occupants should stay in the vehicle while the attendant watches the scale.

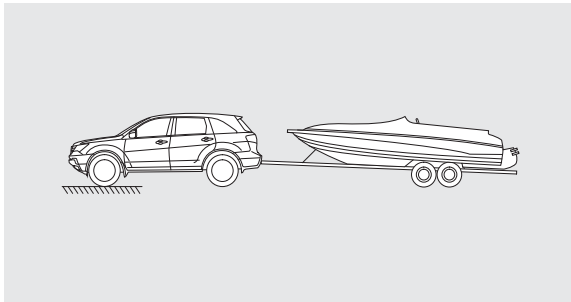

1. Check the front gross axle weight.
Limit: 2,888 lbs (1,310 kg)

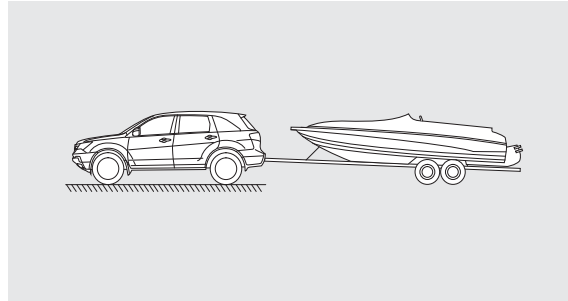

2. Check the gross vehicle weight.
Limit: 5,952 lbs (2,700 kg)
3. Check the rear gross axle weight.
Limit: 3,175 lbs (1,440 kg)
4. If you cannot weigh the rear axle directly, you can calculate the rear gross axle weight by subtracting the weight in step 1 from the weight in step 2.
Limit: 3,064 lbs (1,390 kg)

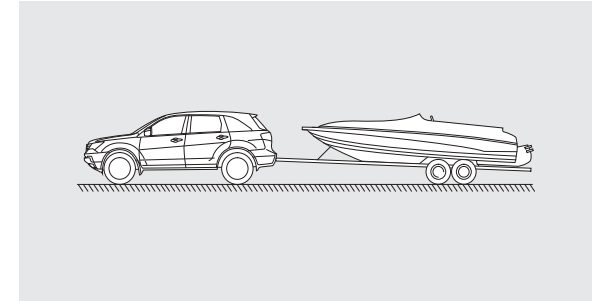

5. Check the gross combined weight.
Limit: 10,053 lbs (4,560 kg)
Remember, maximum gross combined weight should be decreased 2% for every 1,000 feet (305 meters) of elevation.

CONTINUED

Towing a Trailer

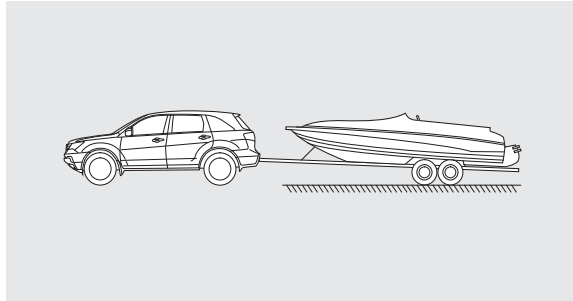

6. Check the weight of the hitched trailer. Write this number down.

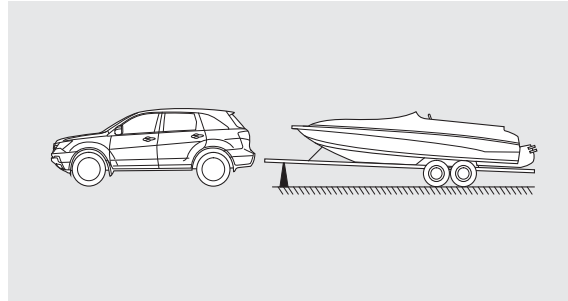

7. Check the weight of the unhitched trailer. Limit: See page 490.
8. Calculate the tongue load. Subtract the weight in step 6 from the weight in step 7.
Limit: See page 490.
Recommended: see page 487.
Range: 5-15% for boat trailers
8-15% for other trailers

Towing Equipment and Accessories

Towing generally requires a variety of supplemental equipment. To ensure the best quality, we recommend that you purchase Acura equipment whenever possible.

Your dealer offers a trailer package that includes a hitch, a ball mount, and a wiring harness.

Discuss any additional needs with your trailer sales or rental agency, and make sure all equipment is properly installed, maintained, and also meets state, federal, province, and local regulations.

Hitch

We strongly recommend that you have your dealer install a class 3 hitch. Using non-Acura equipment may result in serious damage to your vehicle.

Read the trailer manufacturer's instructions, and select the appropriate draw bar for the height of the trailer you will be towing.

Weight Distributing Hitch

A weight distributing hitch is not recommended for use with your vehicle, as an improperly adjusted weight distributing hitch may reduce handling, stability, and braking performance.

Trailer Brakes

Acura recommends that any trailer with a total trailer weight of 1,000 lbs (450 kg) or more has its own brakes.

There are two common types of trailer brakes: surge and electric. Surge brakes are common for boat trailers, since the brakes will get wet.

If you choose electric brakes, be sure they are electronically actuated. Do not attempt to tap into your vehicle's hydraulic system. No matter how successful it may seem, any attempt to attach trailer brakes to your vehicle's hydraulic system will lower braking effectiveness and create a potential hazard.

See your trailer dealer or rental agency for more information on installing electric brakes.

A 4-pin gray connector is available as an option at your dealer. This connector has all of the circuits required to install most electric trailer brake controllers. A jumper harness to adapt your electric trailer brake controller to the vehicle is included with the optional Acura Genuine trailer hitch kit. To obtain a connector and a trailer hitch kit, see your dealer.

Have a qualified mechanic install your trailer brake controller following the trailer brake controller manufacturer's instructions. Failure to properly install the trailer brake controller may increase the distance it takes for you to stop your vehicle when towing a trailer.

CONTINUED

Towing a Trailer

Use this illustration to identify each terminal in the trailer brake controller connector.

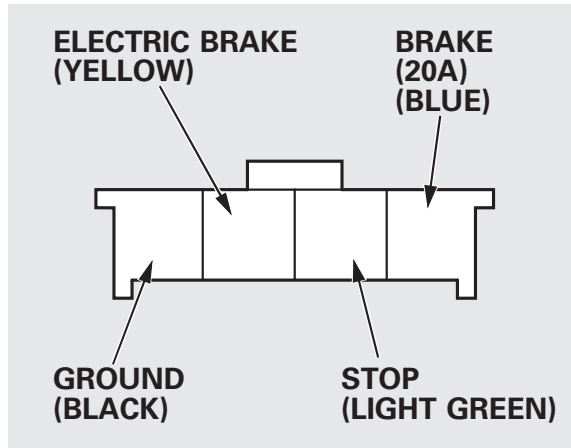

Safety Chains

Always use safety chains when you tow a trailer. Make sure the chains are secured to the trailer and hitch, and that they cross under the tongue and can catch the trailer if it becomes unhitched. Leave enough slack to allow the trailer to turn corners easily, but do not let the chains drag on the ground.

Sway Control

This device is recommended if your trailer tends to sway. Your trailer maker can tell you what kind of sway control you need and how to install it.

Trailer Mirrors

Many states and provinces require special exterior mirrors when towing a trailer. Even if they don't, you should install special mirrors if you cannot clearly see behind you, or if the trailer creates a blind spot.

Spare Tires

When towing a trailer, we recommend that you carry a full-size spare wheel and tire for your vehicle and trailer. See page 545 for proper tire size, page 551 for how to store a full size wheel and tire, and page 551 for information on changing a flat tire.

Remember to unhitch the trailer before changing a flat. Ask your trailer sales or rental agency where and how to store the trailer's spare tire.

Trailer Lights

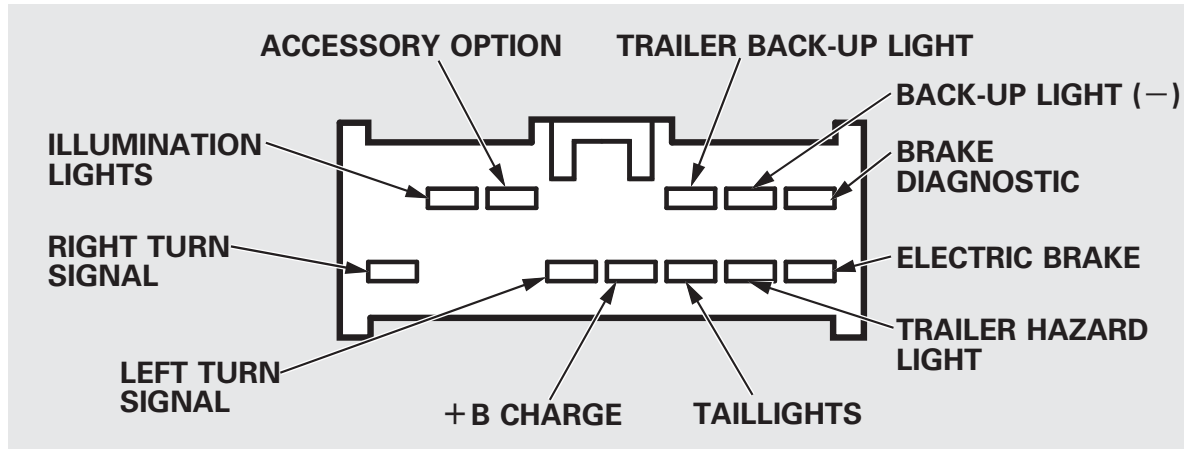

Trailer lights and equipment must comply with federal, state, province, and local regulations. Check trailer light requirements for the areas where you plan to tow, and use only equipment designed for your vehicle.

Your vehicle is equipped with a connector to install an optional trailer lighting connector that mates with your vehicle. You can get this optional connector from your dealer.

Refer to the above illustration for wiring information.

We recommend that you have your dealer install an Acura wiring harness and converter. This harness has been designed for your vehicle.

If you use a non-Acura trailer lighting harness and converter, you can get the mating connector and pins that mate with the connector in your vehicle from your dealer.

Since lighting and wiring vary with trailer type and brand, you should also have a qualified mechanic install a suitable connector between the vehicle and the trailer.

CONTINUED

Towing a Trailer

Pre-Tow Checklist

When preparing to tow, and before driving away, be sure to check the following:

- The vehicle has been properly serviced, and the suspension and the cooling system are in good operating condition.
- The trailer has been properly serviced and is in good condition.
- All weights and loads are within limits.
- The hitch, safety chains, and any other attachments are secure.
- All items on and in the trailer are properly secured and cannot shift while you drive.

- The lights and brakes on your vehicle and the trailer are working properly.
- Your vehicle tires and spare are in good condition and properly inflated.
- The trailer tires and spare are in good condition and inflated as recommended by the trailer maker.

Driving Safely With a Trailer

The added weight, length, and height of a trailer will affect your vehicle's handling and performance, so driving with a trailer requires some special driving skills and techniques.

For your safety and the safety of others, take time to practice driving maneuvers before heading for the open road, and follow the guidelines in this section.

Towing Speeds and Gears

Drive slower than normal in all driving situations, and obey posted speed limits for vehicles with trailers. Use the D position when towing a trailer on level roads. See “***Driving on Hills***” for additional gear information.

When towing a fixed-sided trailer (e. g., camper), do not exceed 55 mph (88 km/h). At higher speeds, the trailer may sway or affect vehicle handling.

If the automatic transmission fluid temperature increases and exceeds the specified limit, the A/T temperature indicator comes on (see page 72). You will also see a “A/T TEMP HIGH” message on the multi-information display.

Making Turns and Braking

Make turns more slowly and wider than normal. The trailer tracks a smaller arc than your vehicle, and it can hit or run over something the vehicle misses.

Allow more time and distance for braking. Do not brake or turn suddenly as this could cause the trailer to jackknife or turn over.

Driving on Hills

When climbing hills, closely watch your temperature gauge. If it nears the red (Hot) mark, turn the air conditioning off, reduce speed and, if necessary, pull to the side of the road to let the engine cool.

If you must stop when facing uphill, use the foot brake or parking brake. Do not try to hold the vehicle in place by pressing on the accelerator, as this can cause the automatic transmission to overheat.

When driving down hills, reduce your speed and shift down to S position, or use the paddle shifters to lower gear (3 or 2) in the S position. When towing a trailer, do not “ride” the brakes, and remember, it takes longer to slow down and stop when towing a trailer.

CONTINUED

Towing a Trailer, Trailer Stability Assist

Handling Crosswinds and Buffeting

Crosswinds and air turbulence caused by passing trucks can disrupt your steering and cause the trailer to sway. When being passed by a large vehicle, keep a constant speed, and steer straight ahead. Do not try to make quick steering or braking corrections.

Backing Up

Always drive slowly and have someone guide you when backing up. Grip the *bottom* of the steering wheel, then turn the wheel to the left to get the trailer to move to the left. Turn the wheel to the right to move the trailer to the right.

Parking

Follow all normal precautions when parking, including putting the transmission in Park and firmly setting the parking brake. Also, place wheel chocks at each of the trailer's tires.

Retrieving a Boat

If the vehicle tires slip when retrieving a boat from the water, keep the transmission in the D position and do not use the sequential sport shift mode. This prevents the transmission damage.

Towing Your Vehicle

Your vehicle is not designed to be towed behind a motor home. If your vehicle needs to be towed in an emergency, see page 572.

Trailer Stability Assist

Your vehicle is equipped with trailer stability assist function. This function works on the same sensors as the vehicle stability assist (VSA) system. This function helps to stabilize the vehicle/trailer combination when the trailer severely sways or oscillates. For more information on the VSA system, see page 473.

If the function detects vehicle/trailer instability, it checks if the swaying is caused by the trailer, and if the trailer swaying or oscillation is increasing.

The vehicle/trailer combination is more affected by crosswinds, buffeting, and improper tongue load. These conditions can make the trailer unstable, and cause it to sway.

Under these conditions, trailer stability assist begins to stabilize the vehicle/trailer combination by reducing the vehicle speed. The control unit sends signals to selectively apply the brakes and regulate the engine output. The brake lights of your vehicle will be turned on automatically by the system even if you do not keep the pressure on the brake pedal.

When the brakes are applied, the trailer's brake lights come on along with the vehicle brake lights.

When the trailer stability assist activates, you will see the VSA system indicator blink. There may also be some noise from the VSA hydraulic system.

Trailer stability assist cannot prevent a loss of control. Always reduce the vehicle speed and steer firmly. Do not brake suddenly or make quick steering motion. It could cause the trailer to jackknife or turn over and the system becomes ineffective.

Trailer stability assist cannot prevent swaying that can occur in crosswinds and in normal and emergency driving maneuvers. It helps only to stabilize the vehicle/trailer combination in these conditions, after the oscillation becomes severe.

Trailer stability assist will also be ineffective while driving at high speed or towing a trailer with a high center of gravity.

Always obey the recommended speed limits for towing a trailer, see page 497.

Trailer Stability Assist Failure



The control unit monitors the VSA circuitry and the braking system. If there is a problem with the brake lighting system, the trailer stability assist function shuts down and the "CHECK TRAILER STABILITY ASSIST" message appears on the multi-information display.

If you see this message, have your vehicle checked at your dealer as soon as possible.

CONTINUED

Trailer Stability Assist, Off-Highway Driving Guidelines

In this case, your vehicle still has the VSA traction and stability enhancement, but it will not have the trailer stability assist function.

If there is a problem with the VSA system, the system and trailer stability assist shuts off. The VSA system indicator also come on (see page 473).

The ABS indicator and the brake system indicator may also come on along with the VSA system indicator.

If you see these warning indicators, have your vehicle checked at your dealer as soon as possible.

If you turn off the VSA, the trailer stability assist function also shuts off. Press and hold the VSA off button until you hear a beep (see page 474). The VSA off indicator comes on as a reminder. Press and hold the switch again to turn the system on.

The function turns on every time you start the engine along with the VSA, even if you turned it off the last time you drove the vehicle.

Off-Highway Driving Guidelines General Information

Your vehicle has been designed primarily for use on pavement. But its higher ground clearance and super handling-all wheel drive (SH-AWD) system allow you to occasionally travel on unpaved roads, to campgrounds, picnic sites, and similar locations. It is not designed for trailblazing, mountain climbing, or other challenging off-road activities.

If you decide to drive on unpaved roads, you will find that it requires somewhat different driving skills. Your vehicle will also handle somewhat differently than it does on pavement. Be sure to pay extra attention to the precautions and tips in this section, and get acquainted with your vehicle before leaving the pavement.

⚠ WARNING

Improperly operating this vehicle on or off-pavement can cause a crash or rollover in which you and your passengers could be seriously injured or killed.

- Follow all instructions and guidelines in this owner's manual.
- Keep your speed low, and don't drive faster than conditions permit.

Important Safety Precautions

To avoid loss of control or rollover, be sure to follow all precautions and recommendations.

- Be sure to store cargo properly and do not exceed your cargo load limits (see page 434 and 487).
- Whenever you drive, make sure you and your passengers always wear seat belts.
- Keep your speed low, and never go faster than the conditions allow.
- It's up to you to continually assess the situation and drive within the limits.

Check Out Your Vehicle

Before you leave the pavement, be sure to do all scheduled maintenance and service, and inspect your vehicle for any problems. Pay special attention to the condition of the tires, and check the tire pressures.

After you return to the pavement, carefully inspect your vehicle to make sure there is no damage that could make driving it unsafe. Recheck the condition of the tires and the tire pressures.

Remember

The route presents limits (too steep or bumpy roads). You have limits (driving skill and comfort). And your vehicle has limits (traction, stability, and power).

Driving off-highway can be hazardous if you fail to recognize limits and take the proper precautions.

CONTINUED

Off-Highway Driving Guidelines

Accelerating and Braking

For better traction on all surfaces, accelerate slowly and gradually build up speed. If you try to start too fast on wet soil, mud, snow, or ice, you might not have enough traction to get underway, and you may dig yourself a hole. Starting with the shift lever in the D position will help you have a smoother start on snow or ice.

Keep in mind that you will usually need more time and distance to brake to a stop on unpaved surfaces. Avoid hard braking. Do not “pump” the brakes; let the anti-lock braking system pump them for you.

Avoiding Obstacles

Debris in the road can damage your suspension or other components. Because your vehicle has a high center of gravity, driving over a large obstacle, or allowing a wheel to drop into a deep hole can cause your vehicle to tip or roll over.

Driving on Slopes

If you can't clearly see all conditions or obstacles on a slope, walk the slope before you drive on it. If you have any doubt whether or not you can safely drive on the slope, don't do it. Find another route.

If you are driving up a hill and find that you cannot continue, *do not try to turn around*. Your vehicle could roll over. Slowly back down the hill, following the same route you took up the hill.

Crossing a Stream

Before driving through water, stop, get out if necessary, and make sure that:

- The water is not deep enough to cover your wheel hubs, axles, or exhaust pipe. You could stall and not be able to restart your engine. The water can also damage important vehicle components.

- The banks are sloped so you can drive out.
- The water is not flowing too fast. Deep rushing water can sweep you downstream. Even very shallow rushing water can wash the ground from under your tires and cause you to lose traction and possibly roll over.
- The banks and surface under the water provide good traction. The water may hide hazards such as rocks, holes, or mud.

If you decide it is safe to drive through water, choose a suitable speed, and proceed without shifting, changing speeds, stopping, or shutting off the engine.

After driving through water, test your brakes. If they got wet, gently “pump” them while driving slowly until they operate normally.

If the water is deeper than the wheel hubs, some additional service may be required. This service is not covered by your warranties.

If You Get Stuck

If you get stuck, carefully try to go in the direction (forward or reverse) that you think will get you unstuck. Do not spin the tires at high speeds. It will not help you get out and may cause damage to the transmission or SH-AWD system.

If you are still unable to free yourself, your vehicle is equipped with front and rear tow hooks designed for this purpose.

Use a nylon strap to attach the MDX to the recovery vehicle and carefully take out the slack in the strap. Once the strap is tight, the recovery vehicle should apply force. Remember that the recovery vehicle needs good traction to avoid becoming stuck, too.

You should never use a jack to try to get unstuck. Your vehicle could easily slip off the jack and hurt you or someone else.

Towing a Trailer Off-Road

You may be able to safely tow a lightweight trailer (such as a motorcycle or small tent trailer) off-road if you follow these guidelines:

- Do not exceed 1,000 lbs (450 kg) or a tongue weight of 100 lbs (45 kg).
- Stay on smooth, level dirt roads, and avoid driving in hilly terrain.
- Allow extra room for starting, stopping, and turning.
- Slow down if you encounter bumps or other obstacles.

This section explains why it is important to keep your vehicle well maintained and how to follow basic maintenance safety precautions.

This section also includes instructions on how to read the Maintenance Minder messages on the multi-information display, and instructions for simple maintenance tasks you may want to take care of yourself.

If you have the skills and tools to perform more complex maintenance tasks on your vehicle, you may want to purchase the service manual. See page 597 for information on how to obtain a copy, or see your dealer.

U.S. Vehicles:
Maintenance, replacement, or repair of emissions control devices and systems may be done by any automotive repair establishment or individual using parts that are “certified” to EPA standards.

Maintenance Safety.....	506
Maintenance Minder™	507
Fluid Locations	515
Engine Compartment Cover.....	516
Adding Engine Oil	517
Changing the Engine Oil and Filter	518
Engine Coolant	520
Windshield Washers.....	522
Automatic Transmission Fluid	523
Brake Fluid	525
Power Steering Fluid	526
Timing Belt.....	526
Lights.....	527
Dust and Pollen Filter	534
Cleaning the Seat Belts	534
Floor Mats	535
Wiper Blades	536
Tires	540
Checking the Battery	547
Vehicle Storage.....	548

Maintenance Safety

All service items not detailed in this section should be performed by a certified technician or other qualified mechanic.

Important Safety Precautions

To eliminate potential hazards, read the instructions before you begin, and make sure you have the tools and skills required.

- Make sure your vehicle is parked on level ground, the parking brake is set, and the engine is off.
- To clean parts, use a commercially available degreaser or parts cleaner, not gasoline.
- To reduce the possibility of fire or explosion, keep cigarettes, sparks, and flames away from the battery and all fuel-related parts.

- Wear eye protection and protective clothing when working with the battery or compressed air.

WARNING

Improperly maintaining this vehicle, or failing to correct a problem before driving can cause a crash in which you can be seriously hurt or killed.

Always follow the inspection and maintenance recommendations and schedules in this owner's manual.

Potential Vehicle Hazards

- **Carbon Monoxide poison from engine exhaust.** Be sure there is adequate ventilation whenever you operate the engine.

- **Burns from hot parts.** Let the engine and exhaust system cool down before touching any parts.
- **Injury from moving parts.** Do not run the engine unless instructed to do so.

WARNING

Failure to properly follow maintenance instructions and precautions can cause you to be seriously hurt or killed.

Always follow the procedures and precautions in this owner's manual.

Some of the most important safety precautions are given here. However, we cannot warn you of every conceivable hazard that can arise in performing maintenance. Only you can decide whether or not you should perform a given task.

One of the most convenient and important features of the multi-information display on your vehicle is the Maintenance Minder™.

Based on engine operating conditions and accumulated engine revolutions, the onboard computer in your vehicle calculates the remaining engine oil life.

The system also displays the code for other scheduled maintenance items needing service.

Engine Oil Life

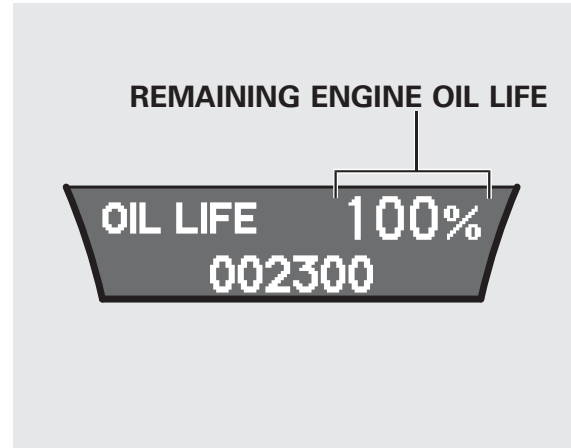

To see the remaining engine oil life displayed on the multi-information display as a percentage, turn the ignition switch to the ON (II) position. Make sure the display shows blank, SH-AWD and tire pressure, and then press the SEL/RESET button on the steering wheel repeatedly until the engine oil life appears (see page 79).

The remaining engine oil life is displayed according to the table shown below.

Calculated Engine Oil Life (%)	Displayed Engine Oil Life (%)
100% – 91%	100%
90% – 81%	90%
80% – 71%	80%
70% – 61%	70%
60% – 51%	60%
50% – 41%	50%
40% – 31%	40%
30% – 21%	30%
20% – 16%	20%
15% – 11%	15%
10% – 6%	10%
5% – 1%	5%
0%	0%

Maintenance

CONTINUED

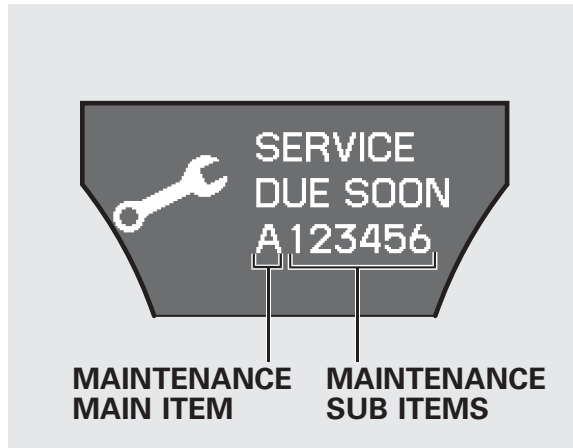

When the remaining engine oil life is 15 to 6 percent, the multi-information display shows a “SERVICE DUE SOON” message along with the maintenance schedule code indicating the main and sub items required at the time of the oil change. Refer to page 514 for a complete list of the maintenance main items and sub items.

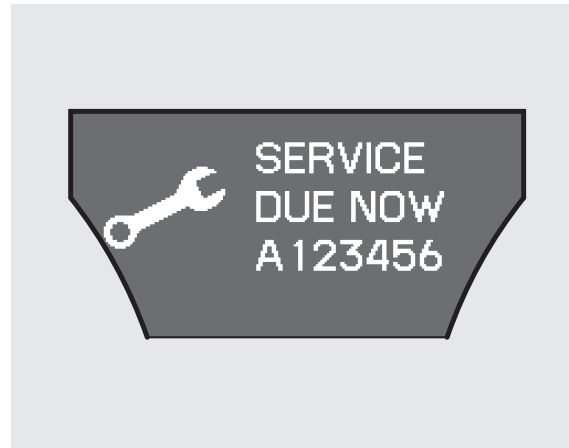

When the remaining oil life is 1 to 5 percent, the multi-information display shows a “SERVICE DUE NOW” message with the same maintenance items “SERVICE DUE SOON” was displayed with. When you see this message have the indicated maintenance performed as soon as possible.

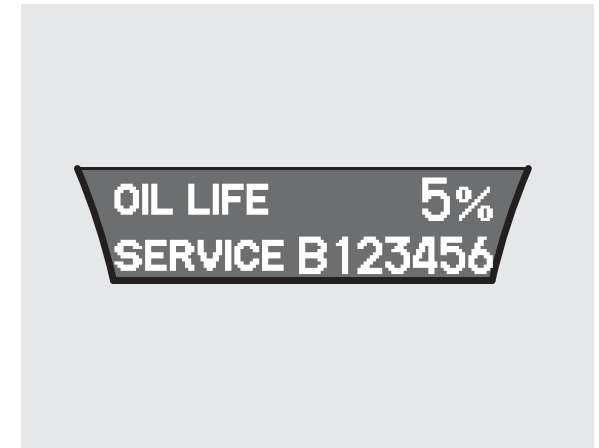

Press the SEL/RESET button on the steering wheel repeatedly to select the engine oil life. The message “SERVICE”, along with “5%”, and the maintenance item code are displayed on the lower part of the multi-information display when the calculated engine oil life is 1 – 5 percent (see page 507).

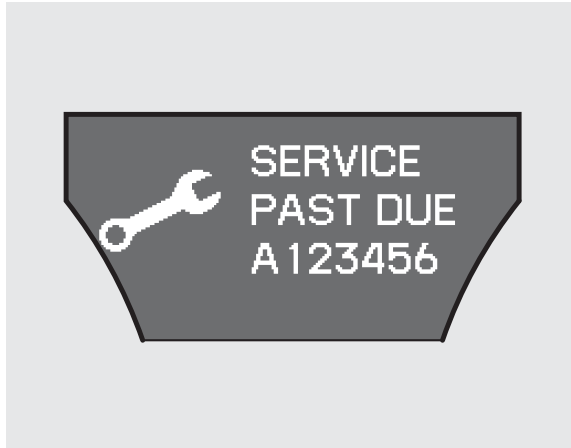

If the indicated maintenance service is not done and the remaining engine oil life reaches 0%, the multi-information display will show the message “SERVICE PAST DUE” and the maintenance item code(s). This message is displayed again when the total distance traveled is less than 10 miles (for U.S. models) or 10 km (for Canadian models) after the engine oil life became 0%.

These messages will come on every time you turn the ignition switch to the ON (II) position.

Immediately have the service performed, and make sure to reset the oil life minder as previously described.

The message will be canceled if the INFO (▲/▼) button on the steering wheel is pressed. Press the INFO (▲/▼) button to see the message again.

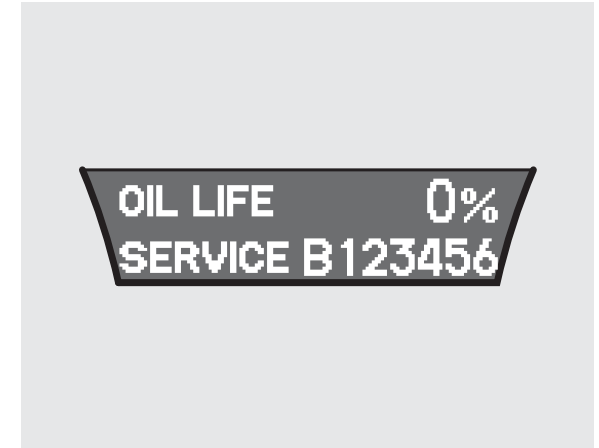

Press the SEL/RESET button on the steering wheel repeatedly to select the engine oil life. The message “SERVICE”, along with “0%”, and the maintenance item code are displayed on the lower part of the multi-information display when the calculated engine oil life is 0 – 1%.

CONTINUED

Maintenance Minder™

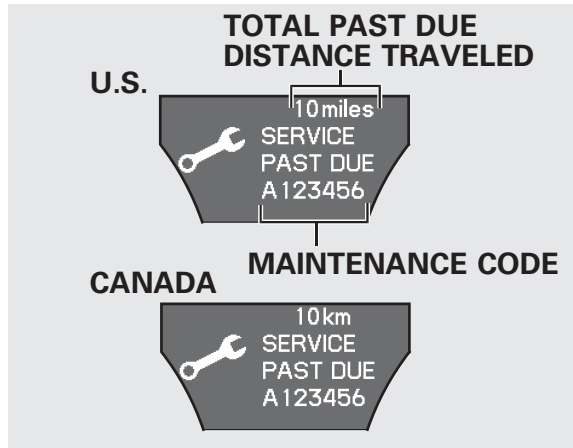

If the indicated required service is not done and the remaining engine oil life becomes 0%, the multi-information display will show a “SERVICE PAST DUE” message, the total distance traveled after the remaining oil life became 0%, and the maintenance item code(s).

This message is displayed when you drive over 10 miles (for U.S. models) or 10 km (for Canadian models) after seeing the 0% message.

Immediately have the service performed, and make sure to reset the display as previously described.

The message will be canceled if the INFO (▲/▼) button on the steering wheel is pressed. Press the INFO (▲/▼) button to see the message again.

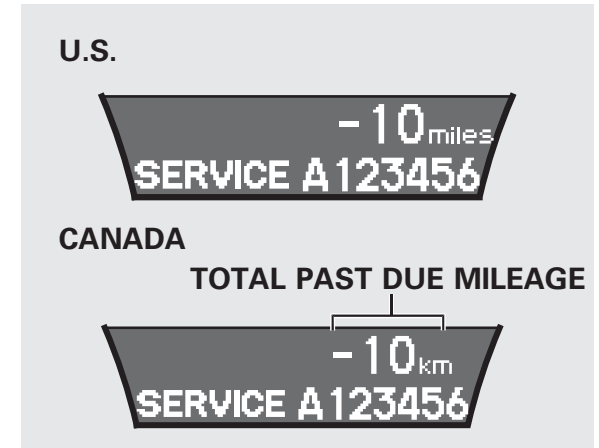

When you press the SEL/RESET button to select the engine oil life, the message “SERVICE”, along with the maintenance item code and the total negative mileage after the oil life became 0%, will be displayed on the lower part of the multi-information display.

Maintenance Main Items and Sub Items

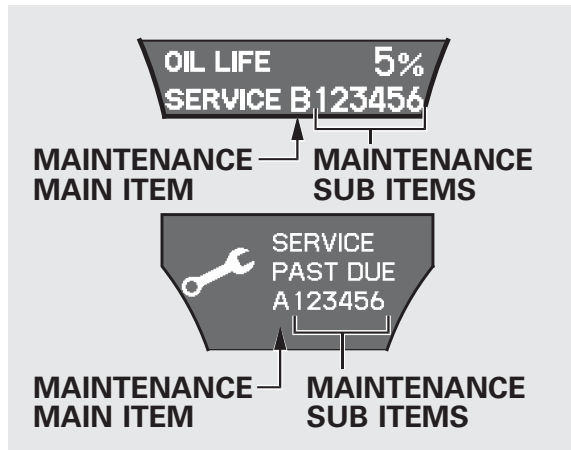

All the maintenance items displayed in the multi-information display are in code.

For an explanation of the maintenance codes, see page 514.

Resetting the Engine Oil Life Display

Your dealer will reset the display after completing the required maintenance service. You will see “OIL LIFE 100%” on the display the next time you turn the ignition switch to the ON (II) position.

If maintenance service is done by someone other than your dealer, reset the Maintenance Minder as follows:

1. Turn the ignition switch to the ON (II) position.
2. If the engine oil life is not displayed, press the SEL/RESET button on the steering wheel repeatedly until the multi-information display shows blank, SH-AWD and tire pressure.
3. Press and hold the SEL/RESET button on the steering wheel for more than 10 seconds. The remaining engine oil life reset mode will be shown on the multi-information display.

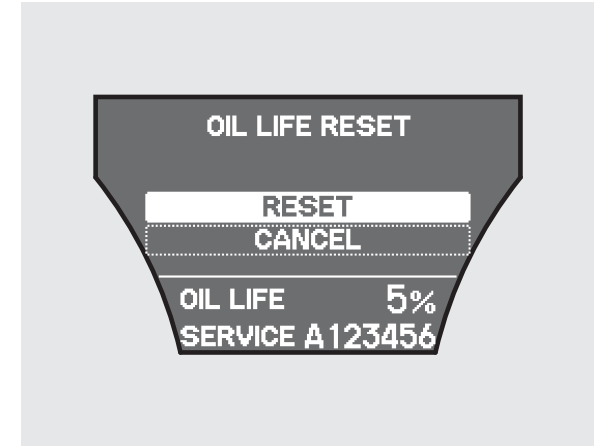

4. Select “RESET” by pressing the INFO (▲/▼) button, then press the SEL/RESET button to reset the engine oil life display. The maintenance item code(s) will disappear, and the engine oil life will reset to “100.” If you want to cancel the oil life reset mode, select “CANCEL.”

CONTINUED

Important Maintenance Precautions

If you have the required service done but do not reset the display, or reset the display without doing the service, the system will not show the correct maintenance intervals. This can lead to serious mechanical problems because you will no longer have an accurate record of when maintenance is needed.

Your authorized dealer knows your vehicle best and can provide competent, efficient service. However, service at a dealer is not mandatory to keep your warranties in effect. Maintenance may be done by any qualified service facility or person who is skilled in this type of automotive service. Keep all receipts as proof of completion, and have the person who does the work fill out your Maintenance Journal or Canadian Maintenance Log. Check your warranty booklet for more information.

We recommend using Acura parts and fluids whenever you have maintenance done. These are manufactured to the same high-quality standards as the original components, so you can be confident of their performance and durability.

U.S. Vehicles:

According to state and federal regulations, failure to perform maintenance on the items marked with # will not void your emissions warranties. However, Acura recommends that all maintenance services be performed in accordance with the intervals indicated by the multi-information display.

Owner's Maintenance Checks

You should check the following items at the specified intervals. If you are unsure of how to perform any check, turn to the appropriate page listed.

- Engine oil level – Check every time you fill the fuel tank. See page 427.
 - Engine coolant level – Check the radiator reserve tank every time you fill the fuel tank. See page 427.
 - Automatic transmission – Check the fluid level monthly. See page 523.
 - Brakes – Check the fluid level monthly. See page 525.
 - Tires – Check the tire pressure monthly. Examine the tread for wear and foreign objects. See page 541.
- Lights – Check the operation of all the lights monthly. See page 527.

Maintenance Minder™

Symbol	Maintenance Main Items
A	<ul style="list-style-type: none"> • Replace engine oil¹
B	<ul style="list-style-type: none"> • Replace engine oil¹ and oil filter • Inspect front and rear brakes • Check parking brake adjustment • Inspect these items: <ul style="list-style-type: none"> • Tie rod ends, steering gear box, and boots • Suspension components • Driveshaft boots • Brake hoses and lines (including ABS/VSA) • All fluid levels and condition of fluids • Exhaust system[#] • Fuel lines and connections[#]

1: If the message "SERVICE DUE NOW" does not appear more than 12 months after the display is reset, change the engine oil every year.

#: See information on maintenance and emissions warranty in the first column on page 512.

NOTE: • Independent of the Maintenance Minder information, replace the brake fluid every 3 years.

- Inspect idle speed every 160,000 miles (256,000 km).
- Adjust the valves during services A, B, 1, 2, or 3 if they are noisy.

Symbol	Maintenance Sub Items
1	<ul style="list-style-type: none"> • Rotate tires
2	<ul style="list-style-type: none"> • Replace air cleaner element If you drive in dusty conditions, replace every 15,000 miles (24,000 km). • Replace dust and pollen filter If you drive primarily in urban areas that have high concentrations of soot in the air from industry and from diesel-powered vehicles, replace every 15,000 miles (24,000 km). • Inspect drive belt
3	<ul style="list-style-type: none"> • Replace transmission and transfer fluid
4	<ul style="list-style-type: none"> • Replace spark plugs • Replace timing belt and inspect water pump If you drive regularly in very high temperatures (over 110°F, 43°C), in very low temperatures (under -20°F, -29°C), or towing a trailer, replace every 60,000 miles (U. S.)/100,000 km (Canada). • Inspect valve clearance
5	<ul style="list-style-type: none"> • Replace engine coolant
6	<ul style="list-style-type: none"> • Replace rear differential fluid Driving in mountainous areas at very low vehicle speeds or trailer towing results in higher level of mechanical (shear) stress to fluid. This requires differential fluid changes more frequently than recommended by the Maintenance Minder. If you regularly drive your vehicle under these conditions, have the differential fluid changed at 7,500 miles (12,000 km), then every 15,000 miles (24,000 km).

Fluid Locations

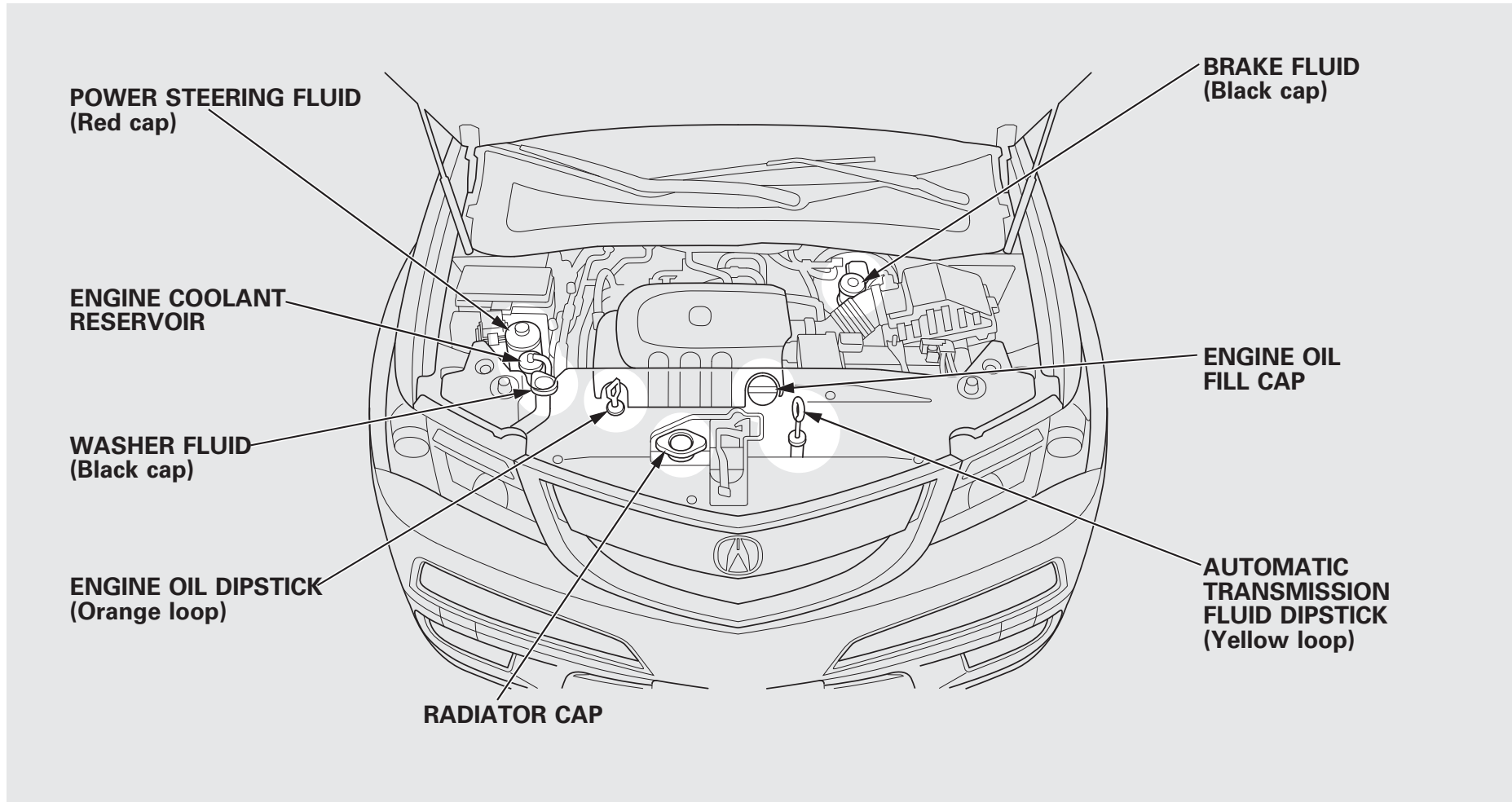

Engine Compartment Cover

The component parts in the engine compartment are protected by the cover. You may need to remove the cover when you perform some simple maintenance work.

Cover is secured by holding clips.

To remove the front bulkhead cover, remove the holding clips with a flat-tip screwdriver.

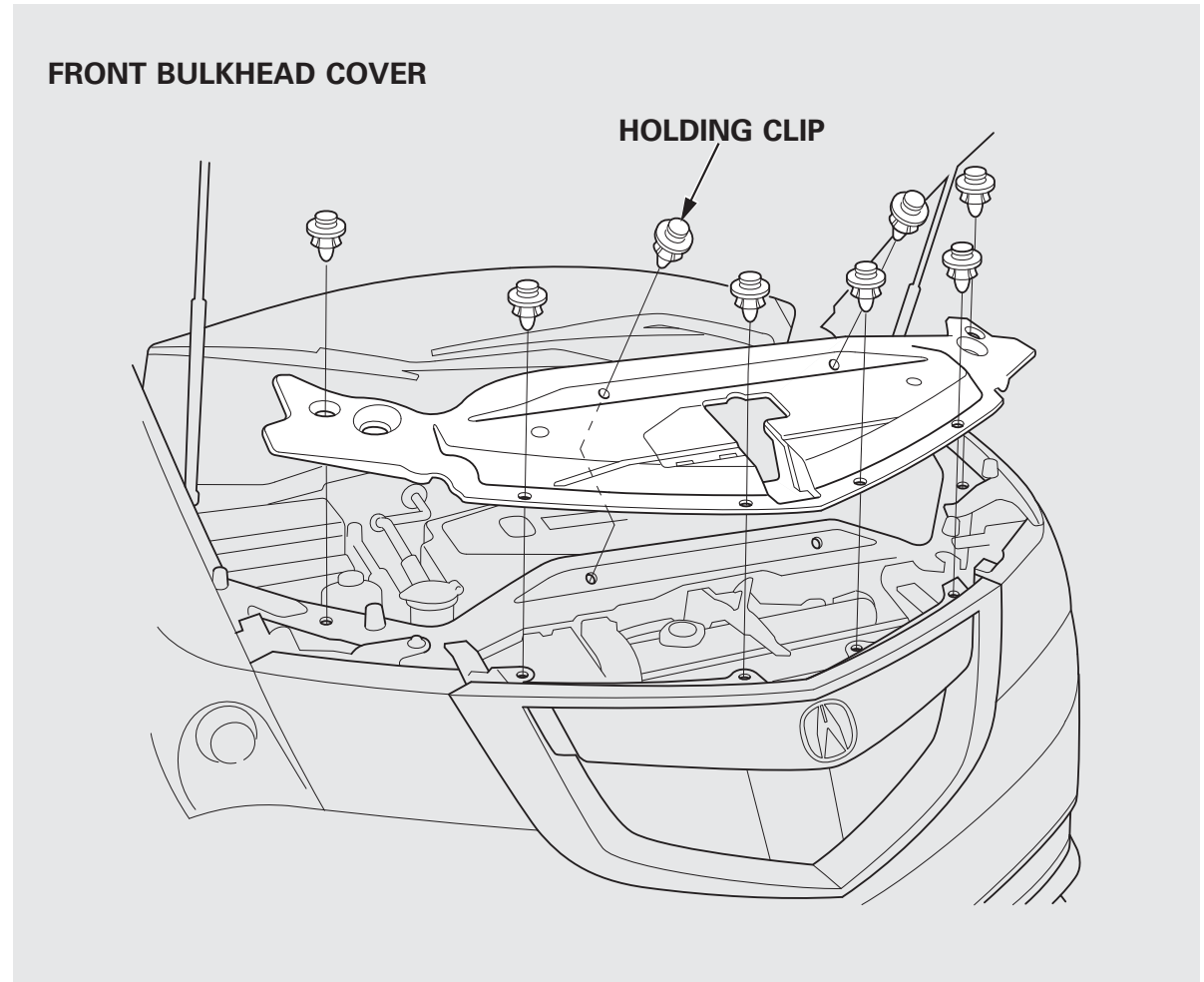

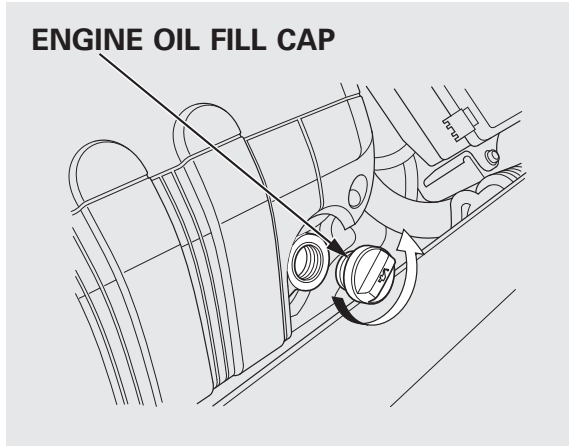

Unscrew and remove the engine oil fill cap on top of the valve cover. Pour in the oil slowly and carefully so you do not spill. Clean up any spills immediately. Spilled oil could damage components in the engine compartment. Reinstall the engine oil fill cap, and tighten it securely. Wait a few minutes, and recheck the oil level on the engine oil dipstick. Do not fill above the upper mark; you could damage the engine.

Recommended Engine Oil

Oil is a major contributor to your engine's performance and longevity. Always use a premium-grade 5W-20 detergent oil displaying the API Certification Seal. This seal indicates the oil is energy conserving, and that it meets the American Petroleum Institute's latest requirements. It is highly recommended that you use Acura motor oil in your vehicle. Make sure the API Certification Seal says "For Gasoline Engines."



The oil viscosity or weight is provided on the container's label. 5W-20 oil is formulated for year-round protection of your vehicle to improve cold weather starting and fuel economy.

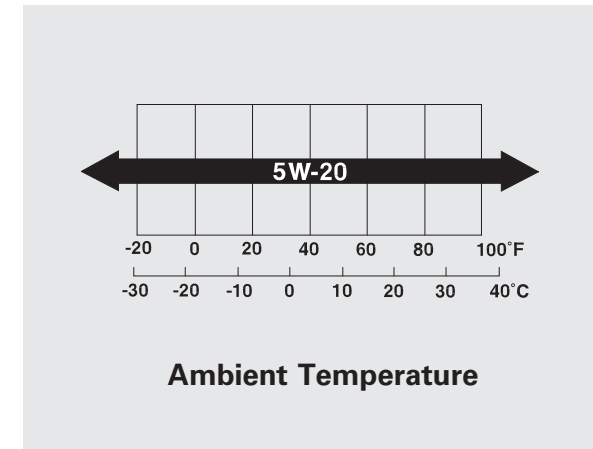

CONTINUED

Adding Engine Oil, Changing the Engine Oil and Filter

Synthetic Oil

You may use a synthetic motor oil if it meets the same requirements given for a conventional motor oil: it displays the API Certification Seal and it is the proper weight. You must follow the oil and filter change intervals shown on the multi-information display.

Engine Oil Additives

Your vehicle does not require any oil additives. Additives may adversely affect the engine or transmission performance and durability.

Changing the Engine Oil and Filter

Always change the oil and filter according to the maintenance messages shown on the multi-information display. The oil and filter collect contaminants that can damage your engine if they are not removed regularly.

Changing the oil and filter requires special tools and access from underneath the vehicle. The vehicle should be raised on a service station-type hydraulic lift for this service. Unless you have the knowledge and proper equipment, you should have this maintenance done by a skilled mechanic.

1. Run the engine until it reaches normal operating temperature, then shut it off.

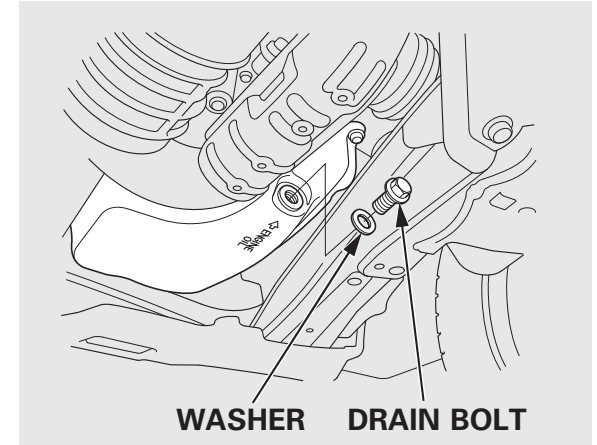

2. Open the hood, and remove the engine oil fill cap. Remove the oil drain bolt and washer from the bottom of the engine. Drain the oil into an appropriate container.

Changing the Engine Oil and Filter

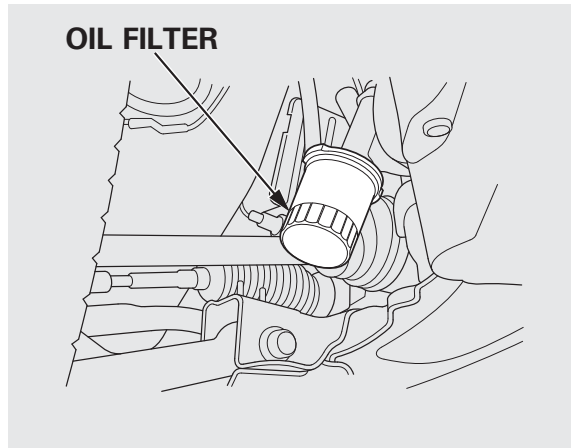

3. Remove the oil filter, and let the remaining oil drain. A special wrench (available from your dealer) is required.

Make sure the oil filter gasket is not stuck to the engine block. If it is, remove it before installing a new oil filter.

4. Install a new oil filter according to the instructions that come with it.
Make sure to clean off any dirt and dust on the connecting surface of a new oil filter.
5. Put a new washer on the drain bolt, then reinstall the drain bolt. Tighten the drain bolt to:
29 lbf·ft (39 N·m, 4.0 kgf·m)
6. Refill the engine with the recommended oil.

Engine oil change capacity
(including filter):
4.5 US qt (4.3 L)

7. Reinstall the engine oil fill cap.
Start the engine. The oil pressure indicator should go out within 5 seconds. If it does not, turn off the engine, and check your work.
8. Let the engine run for several minutes, then check the drain bolt and oil filter for leaks.
9. Turn off the engine and let it sit for several minutes, then check the oil level on the dipstick. If necessary, add more oil.

NOTICE

Improper disposal of engine oil can be harmful to the environment. If you change your own oil, please dispose of the used oil properly. Put it in a sealed container, and take it to a recycling center. Do not discard it in a trash bin or dump it on the ground.

Engine Coolant

Adding Engine Coolant

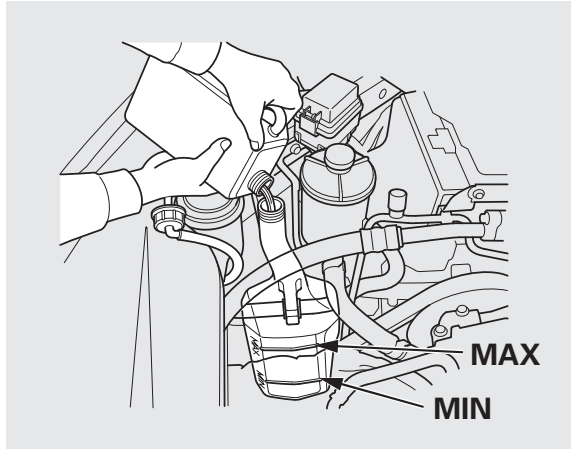

If the coolant level in the reserve tank is at or below the MIN line, add coolant to bring it up to the MAX line. Inspect the cooling system for leaks.

Always use Honda Long-life Antifreeze/Coolant Type 2. This coolant is pre-mixed with 50 percent antifreeze and 50 percent water. Never add straight antifreeze or plain water.

If Honda antifreeze/coolant is not available, you may use another major-brand non-silicate coolant as a temporary replacement. Make sure it is a high-quality coolant recommended for aluminum engines. Continued use of any non-Honda coolant can result in corrosion, causing the cooling system to malfunction or fail. Have the cooling system flushed and refilled with Honda antifreeze/coolant as soon as possible.

If the reserve tank is completely empty, you should also check the coolant level in the radiator.

⚠ WARNING

Removing the radiator cap while the engine is hot can cause the coolant to spray out, seriously scalding you.

Always let the engine and radiator cool down before removing the radiator cap.

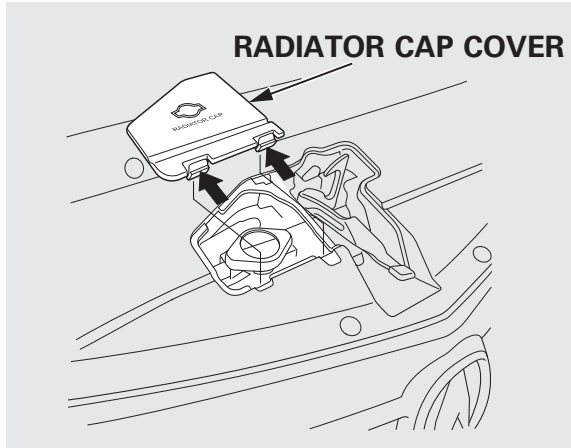

1. Make sure the engine and radiator are cool.
2. Remove the radiator cap cover.

Relieve any pressure in the cooling system by turning the radiator cap counterclockwise, without pressing down.

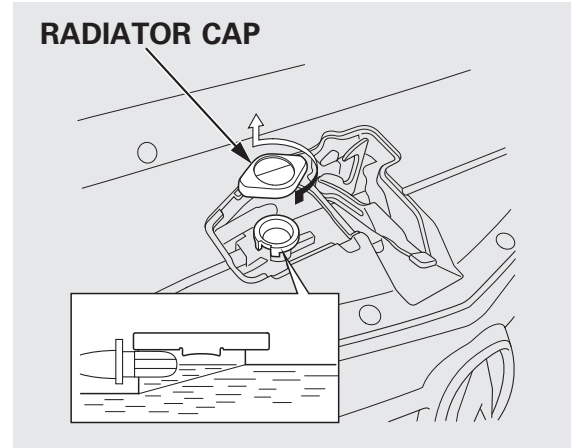

3. Remove the radiator cap by pushing down and turning counterclockwise.

4. The coolant level should be up to the base of the filler neck. Add coolant if it is low.

Pour the coolant slowly and carefully so you do not spill any. Clean up any spill immediately; it could damage components in the engine compartment.

5. Put the radiator cap back on, and tighten it fully.

CONTINUED

Engine Coolant, Windshield Washers

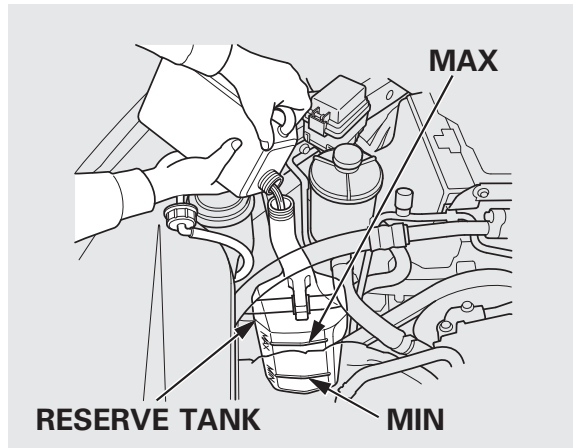

6. Pour coolant into the reserve tank. Fill it to halfway between the MAX and MIN marks. Put the cap back on the reserve tank.

Do not add any rust inhibitors or other additives to your vehicle's cooling system. They may not be compatible with the coolant or engine components.

Windshield Washers

Check the fluid level in the windshield washer reservoir at least monthly during normal use.

If the washer fluid is low, a “LOW WASHER FLUID” message appears on the multi-information display.

Fill the reservoir with a good-quality windshield washer fluid. This increases the cleaning capability and prevents freezing in cold weather.

When you refill the reservoir, clean the edges of the windshield wiper blades with windshield washer fluid on a clean cloth. This will help to condition the blade edges.

NOTICE

Do not use engine antifreeze or a vinegar/water solution in the windshield washer reservoir. Antifreeze can damage your vehicle's paint, while a vinegar/water solution can damage the windshield washer pump. Use only commercially-available windshield washer fluid.

Automatic Transmission Fluid

Check the fluid level with the engine at normal operating temperature.

1. Park the vehicle on level ground. Start the engine, let it run until the radiator fan comes on, then shut off the engine. For accurate results, wait about 60 seconds (but no longer than 90 seconds) before doing step 2.

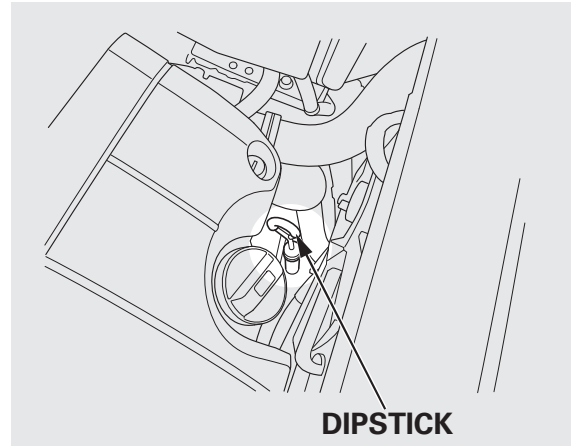

2. Remove the dipstick (yellow loop) from the transmission, and wipe it with a clean cloth.

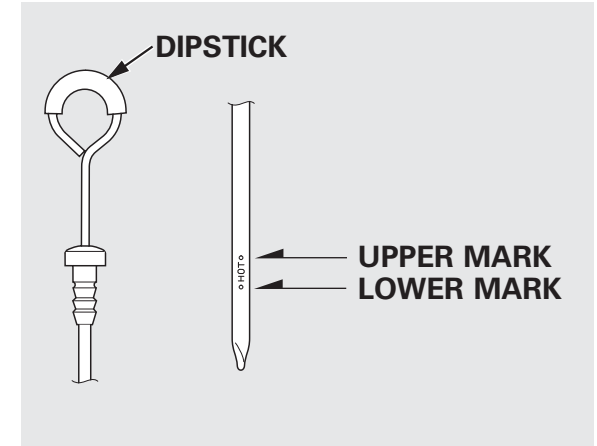

3. Insert the dipstick all the way into the transmission securely as shown in the illustration.
4. Remove the dipstick and check the fluid level. It should be between the upper and lower marks.

Automatic Transmission Fluid

5. If the level is below the lower mark, add fluid into the dipstick hole to bring it to the level between the upper and lower marks.

Pour the fluid slowly and carefully so you do not spill any. Clean up any spill immediately; it could damage components in the engine compartment.

Always use Acura ATF DW-1 (automatic transmission fluid.)

6. Insert the dipstick all the way back into the transmission securely as shown in the illustration.

Make sure the rubber cap on the dipstick fits in the dipstick guide and that you push the dipstick in all the way.

The transmission should be drained and refilled with new fluid when this service is shown on a maintenance message on the multi-information display.

If you are not sure how to add fluid, contact your dealer.

NOTICE

Use only Acura ATF DW-1 (automatic transmission fluid). Do not mix with other transmission fluids.

Using transmission fluid other than Acura ATF DW-1 may cause deterioration in transmission operation and durability, and could result in damage to the transmission.

Damage resulting from the use of transmission fluid other than Acura ATF DW-1 is not covered by the Acura new vehicle warranty.

Independent of the Maintenance Midner information, replace the brake fluid every 3 years.

Check the fluid level in the brake fluid reservoir monthly.

Always use Honda Heavy Duty Brake Fluid DOT 3. If it is not available, you should use only DOT 3 or DOT 4 fluid, from a sealed container, as a temporary replacement.

Using any non-Honda brake fluid can cause corrosion and decrease the life of the system. Have the brake system flushed and refilled with Honda Heavy Duty Brake Fluid DOT 3 as soon as possible.

Brake fluid marked DOT 5 is not compatible with your vehicle's braking system and can cause extensive damage.

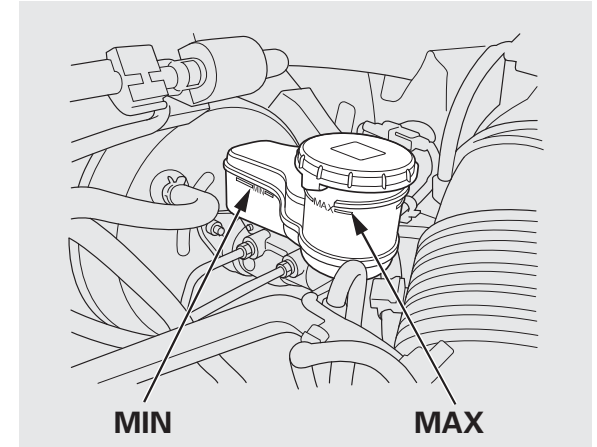

The fluid level should be between the MIN and MAX marks on the side of the reservoir. If the level is at or below the MIN mark, your brake system needs attention. Have the brake system inspected for leaks or worn brake pads.

Power Steering Fluid, Timing Belt

Power Steering Fluid

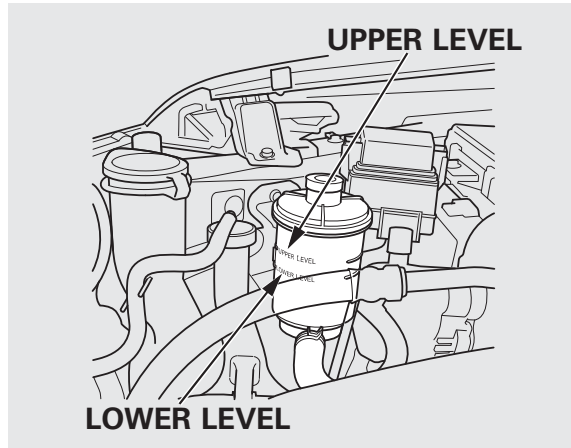

Check the level on the side of the reservoir when the engine is cold. The fluid should be between the UPPER LEVEL and LOWER LEVEL. If not add power steering fluid to the UPPER LEVEL mark.

Pour the fluid slowly and carefully so you do not spill any. Clean up any spills immediately; it could damage components in the engine compartment.

Always use Acura Power Steering Fluid. You may use another power steering fluid as an emergency replacement, but have the power steering system flushed and refilled with Acura PSF as soon as possible.

A low power steering fluid level can indicate a leak in the system. Check the fluid level frequently, and have the system inspected as soon as possible.

If you are not sure how to add fluid, contact your dealer.

NOTICE

Turning the steering wheel to full left or right lock and holding it there can damage the power steering pump.

Timing Belt

The timing belt should be replaced at the intervals shown in the Maintenance Minder schedule.

Replace the timing belt every 60,000 miles (U.S.) or every 100,000 km (Canada) if you regularly drive your vehicle in any of the following conditions:

- In very high temperatures (over 110°F, 43°C).
- In very low temperatures (under -20°F, -29°C).
- Frequently tow a trailer.

Headlight Aiming

The headlights were properly aimed when your vehicle was new. If you regularly carry heavy items in the cargo area or pull a trailer, readjustment may be required. Adjustments should be done by your dealer or another qualified technician.

Low Beam Headlight Bulb Replacement

The low beam headlight bulbs are a type of high voltage discharge tube. High voltage can remain in the circuit even with the light switch off and the key removed. Because of this, you should not attempt to examine or change a low beam headlight bulb yourself. If a low beam headlight bulb fails, take the vehicle to your dealer to have it replaced.

Replacing a High Beam Headlight Bulb

Your vehicle has halogen headlight bulbs. When replacing a bulb, handle it by its base, and protect the glass from contact with your skin or hard objects. If you touch the glass, clean it with denatured alcohol and a clean cloth.

NOTICE

Halogen headlight bulbs get very hot when lit. Oil, perspiration, or a scratch on the glass can cause the bulb to overheat and shatter.

1. Open the hood.
2. Remove the front bulkhead cover (see page 516).

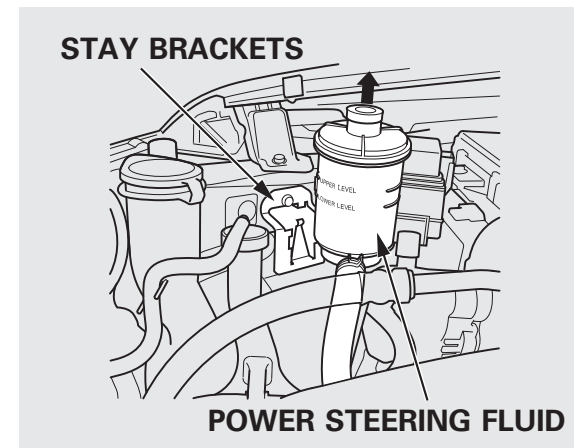

(Passenger's side)
Remove the power steering reserve tank from the stay brackets.

CONTINUED

Lights

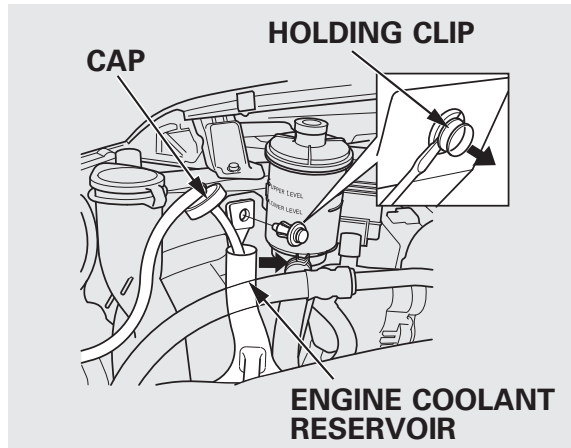

(Passenger's side)

Use a flat-tip screwdriver to remove the holding clip from the engine coolant reserve tank, and then remove the engine coolant reserve tank.

Remove the cap from the engine coolant reserve tank (use towel to wipe fluid).

Unclip hose from the stay brackets on the engine coolant reserve tank.

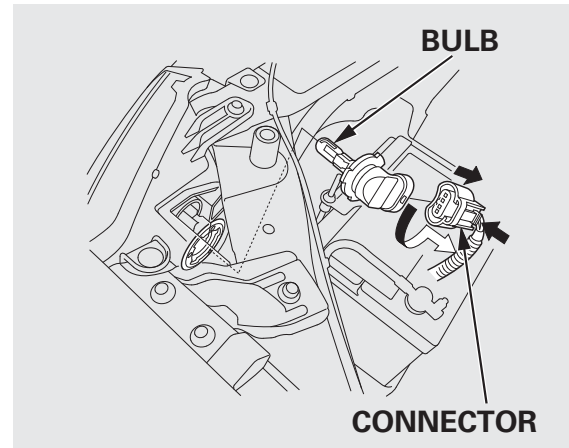

3. Remove the electrical connector from the bulb by pushing on the tab and pulling the connector down.
4. Remove the bulb by turning it about one-quarter turn counterclockwise.

5. Insert the new bulb into the hole, and turn it one-quarter turn clockwise to lock it in place.
6. Push the electrical connector onto the new bulb.
7. Turn on the headlights to test the new bulb.
8. (Passenger's side)
Install the engine coolant reserve tank and power steering reserve tank.

Replacing Front Turn Signal/ Parking and Side Marker Light Bulbs

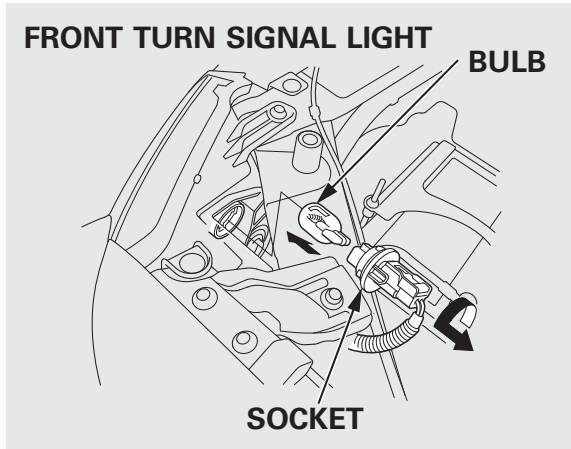

1. Open the hood.
2. Remove the front bulkhead cover (see page 516).
3. Remove the socket by turning it one-quarter turn counterclockwise.
4. Pull the bulb straight out of its socket.

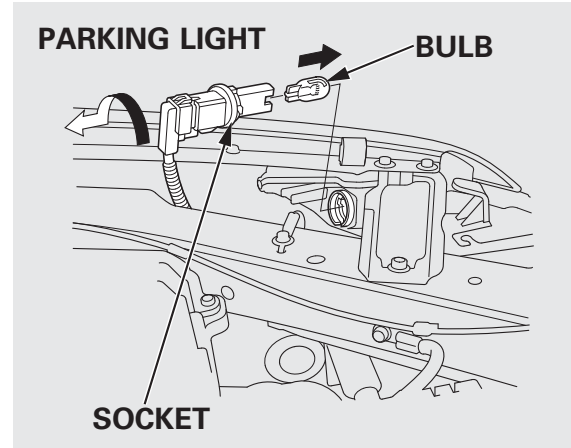

5. Push the new bulb straight into the socket until it bottoms.
6. Insert the socket back into the headlight assembly. Turn it clockwise to lock it in place.
7. Turn on the lights to make sure the new bulb is working.

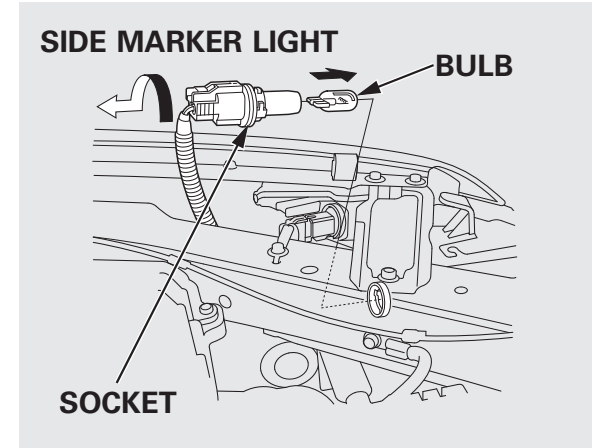

CONTINUED

Lights

Replacing Front Fog/Daytime Running Light Bulbs

Your vehicle uses halogen light bulbs. When replacing a bulb, handle it by its plastic case, and protect the glass from contact with your skin or hard objects. If you touch the glass, clean it with denatured alcohol and a clean cloth.

NOTICE

Halogen bulbs get very hot when lit. Oil, perspiration, or a scratch on the glass can cause the bulb to overheat and shatter.

1. To change the bulb on the driver's side, start the engine, turn the steering wheel all the way to the right, then turn off the engine. To change the bulb on the passenger's side, turn the steering wheel to the left.

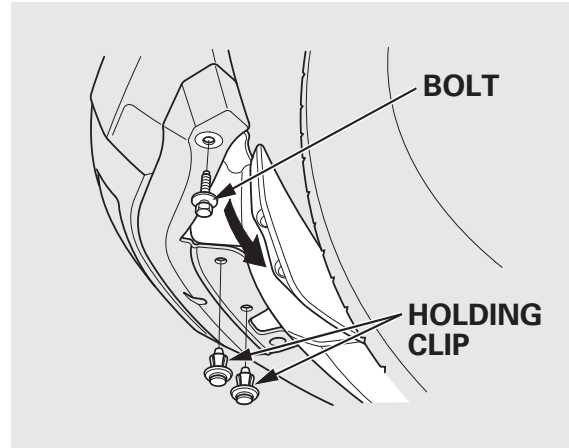

2. Remove the bolt and use the flat-tip screwdriver to remove the holding clips located under the front bumper.

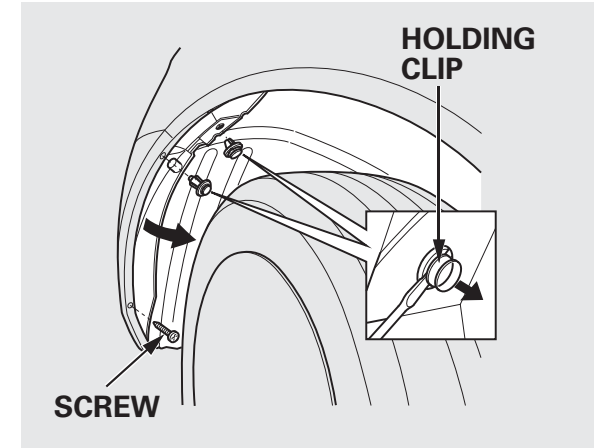

3. Use a flat-tip screwdriver to remove the holding clip from the inner fender, and remove the screw with a Phillips-head screwdriver.
4. Pull the inner fender cover away from the fender and bumper.

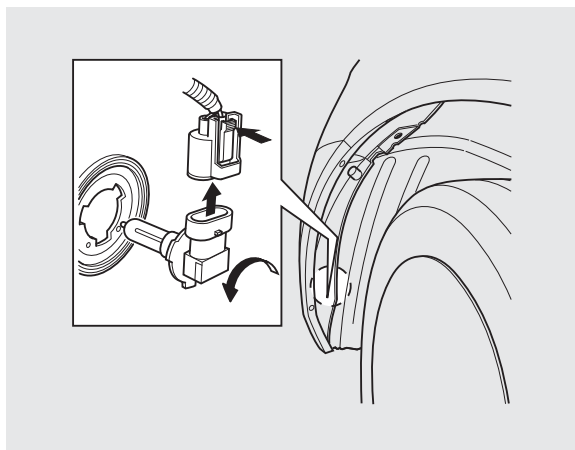

5. Remove the electrical connector from the bulb by pushing on the tab and pulling the connector down.
6. Remove the bulb from the fog light assembly by turning it one-quarter turn counterclockwise.

Replacing Rear Bulbs (in Rear Pillar)

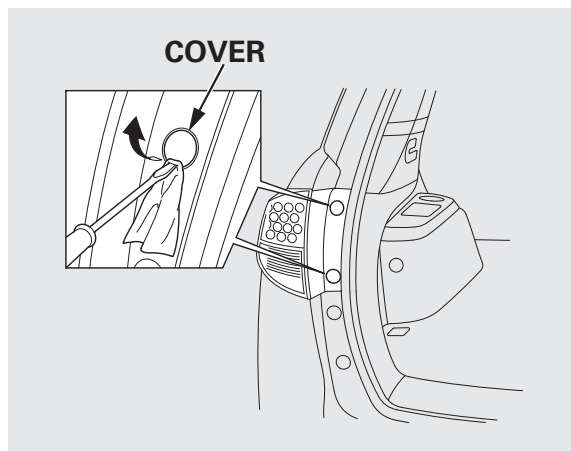

1. Open the tailgate. Put a cloth on the edge of the cover to prevent scratches. Remove the covers by prying the edge with a flat-tip screwdriver.

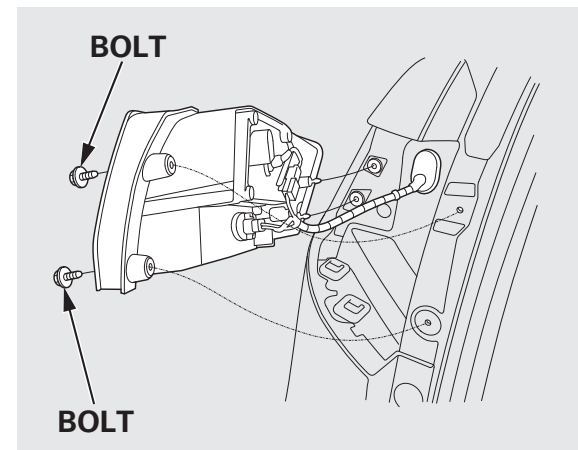

2. Remove the two bolts, and remove the rear light assembly from the rear pillar.
3. Determine which of the two bulbs is burned out: turn signal/hazard lights or side marker light.

CONTINUED

Lights

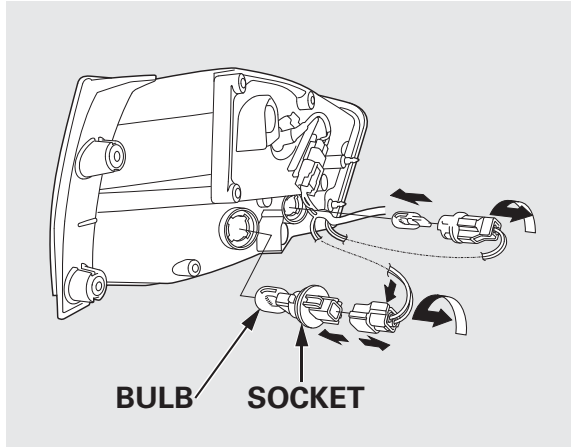

4. Remove the socket by turning it one-quarter turn counterclockwise.
5. Pull the bulb straight out of its socket.

6. Push the new bulb straight into the socket until it bottoms.
7. Turn on the lights to make sure the new bulb is working.
8. Put the socket back into the light assembly, and turn it clockwise to lock it in place.
9. Install the rear light assembly in the rear pillar. Tighten the two bolts. Snap the bolt covers into position.

Replacing a Back-up Light Bulb

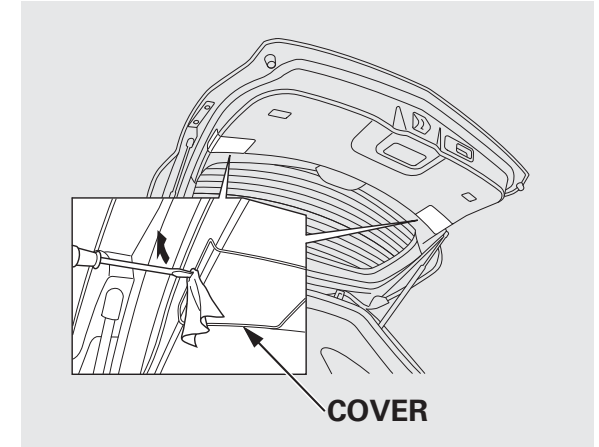

1. Open the tailgate. Place a cloth on the edge of the light assembly cover to prevent scratches. Remove the cover by carefully prying in the notch on its middle edge with a flat-tip screwdriver.

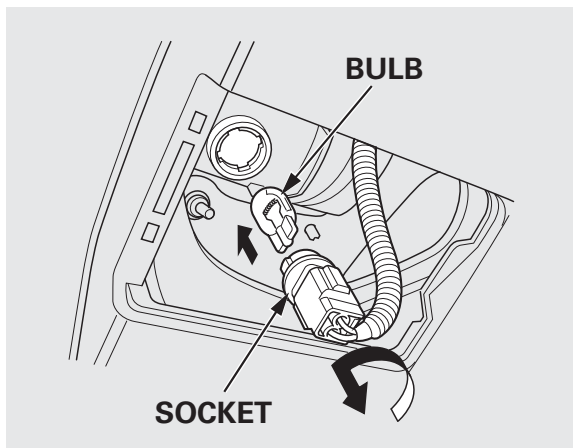

2. Remove the socket by turning it one-quarter turn counterclockwise.
3. Pull the bulb straight out of its socket.
4. Push the new bulb straight into the socket until it bottoms.
5. Turn on the lights to make sure the new bulb is working.

6. Put the socket back into the light assembly, and turn it clockwise to lock it in place.
7. Place the cover back into the light assembly. Push it up until it locks in place.

Side Turn Signal Light

Each outside mirror has side turn signal lights. The lights should be replaced by your dealer.

High-mount Brake Light

The high-mount brake light should be replaced by your dealer.

Rear License Plate Bulb

The license plate has two lights above it. The bulbs should be replaced by your dealer.

Dust and Pollen Filter, Cleaning the Seat Belts

Dust and Pollen Filter

This filter removes the dust and pollen that is brought in from the outside through the climate control system.

Have your dealer replace the filter when this service is indicated by a maintenance message on the multi-information display. It should be replaced every 15,000 miles (24,000 km) if you drive primarily in urban areas that have high concentrations of soot in the air, or if the flow from the climate control system becomes less than usual.

Cleaning the Seat Belts

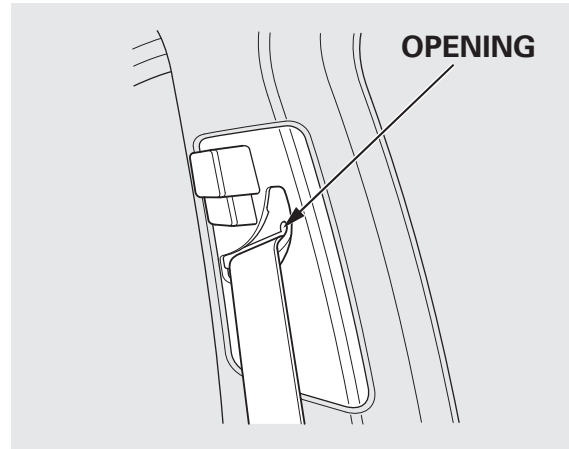

If your seat belts get dirty, use a soft brush with a mixture of mild soap and warm water to clean them. Do not use bleach, dye, or cleaning solvents. Let the belts air-dry before you use the vehicle.

Dirt build-up around the openings of the seat belt anchors can cause the belts to retract slowly. Wipe the openings with a clean cloth dampened in mild soap and warm water or isopropyl alcohol.

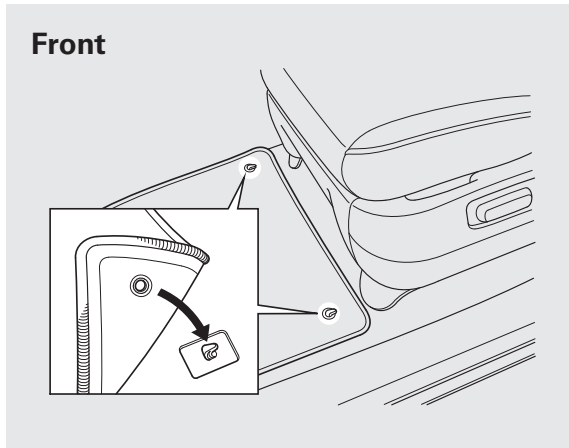

The floor mats that came with your vehicle hook over the floor mat anchors. This keeps the floor mats from sliding forward, possibly interfering with the pedals, or backwards, making the front passenger's weight sensors ineffective.

If you remove a floor mat, make sure to re-anchor it when you put it back in your vehicle.

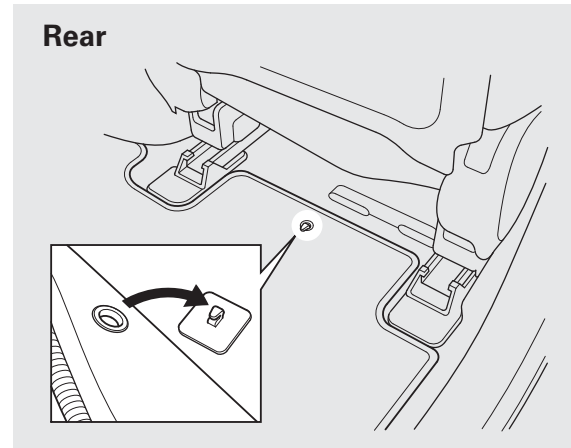

If you use a non-Acura floor mat, make sure it fits properly and that it can be used with the floor mat anchors. Do not put additional floor mats on top of the anchored mats.

Wiper Blades

Check the condition of the wiper blades at least every 6 months. Replace them if you find signs of cracking in the rubber, and areas that are getting hard or if they leave streaks and unwiped areas when used.

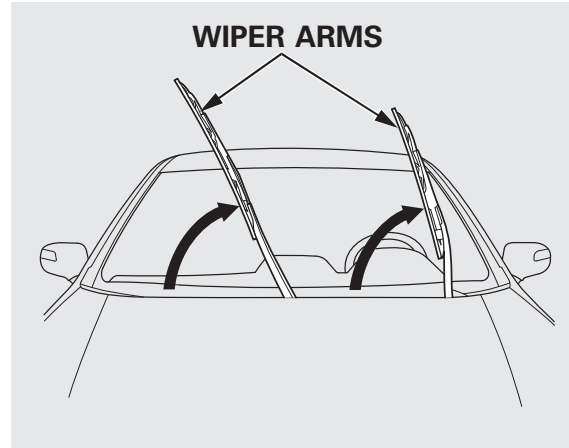

To replace the front wiper blades:

1. Raise each wiper arm off the windshield, lifting the driver's side first, then the passenger's side.

NOTICE

Do not open the hood when the wiper arms are raised, or you will damage the hood and the wiper arms.

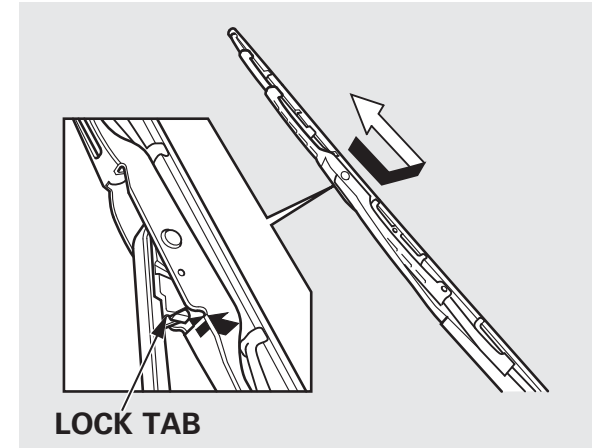

2. Disconnect the blade assembly from the wiper arm:
 - Press and hold the lock tab.
 - Slide the blade assembly toward the lock tab until it releases from the wiper arm.

When replacing a wiper blade, make sure not to drop the wiper blade or wiper arm down on the windshield.

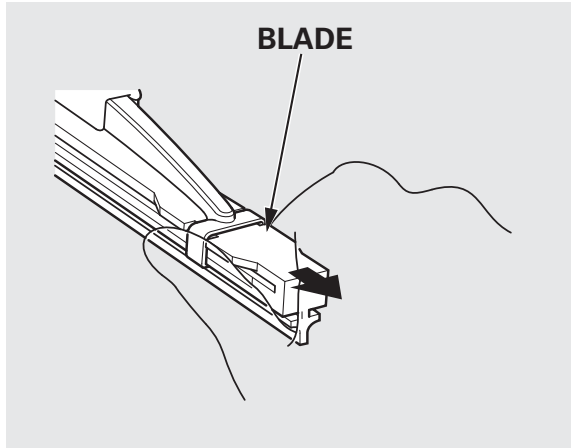

3. Remove the blade from its holder by grabbing the tabbed end of the blade. Pull firmly until the tabs come out of the holder.

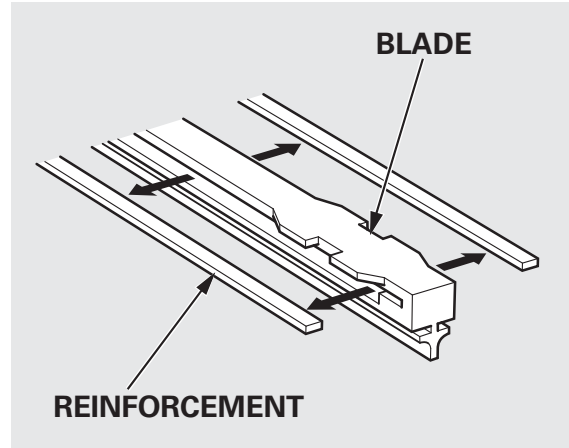

4. Examine the new wiper blades. If they have no plastic or metal reinforcement along the back edge, remove the metal reinforcement strips from the old wiper blade, and install them in the slots along the edge of the new blade.

5. Slide the new wiper blade into the holder until the tabs lock.
6. Slide the wiper blade assembly onto the wiper arm. Make sure it locks in place.
7. Lower the wiper arm against the window.
Windshield: Lower the passenger's side first, then the driver's side.

CONTINUED

Wiper Blades

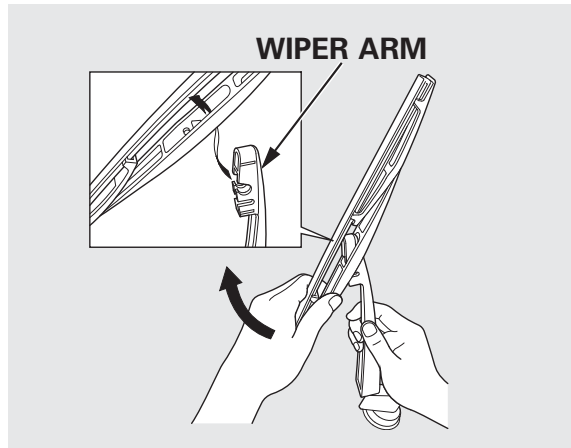

To replace the rear wiper blade:
1. Raise the wiper arm off the rear window.

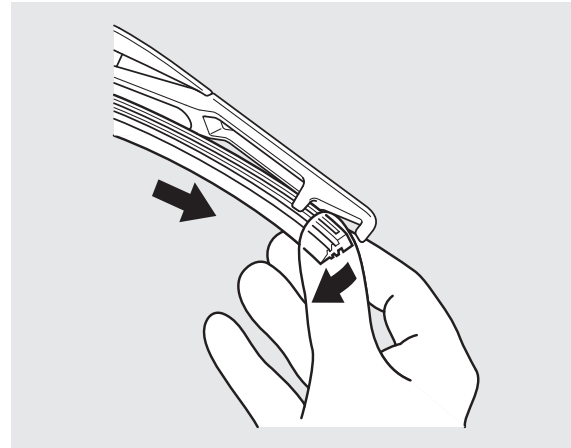

2. Slide the blade out of the wiper arm.

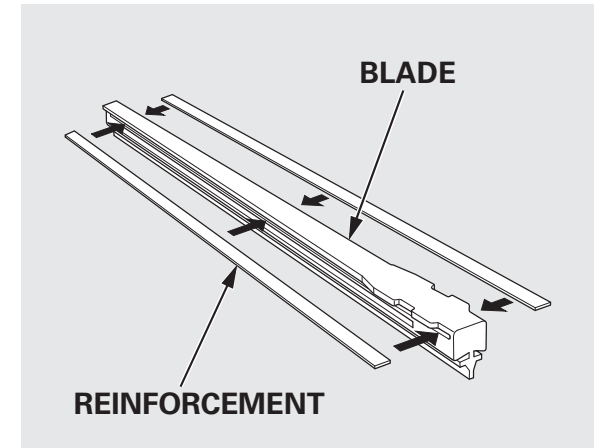

3. Examine the new wiper blades. If they have no plastic or metal reinforcement along the back edge, remove the metal reinforcement strips from the old wiper blade, and install them in the slots along the edge of the new blade.

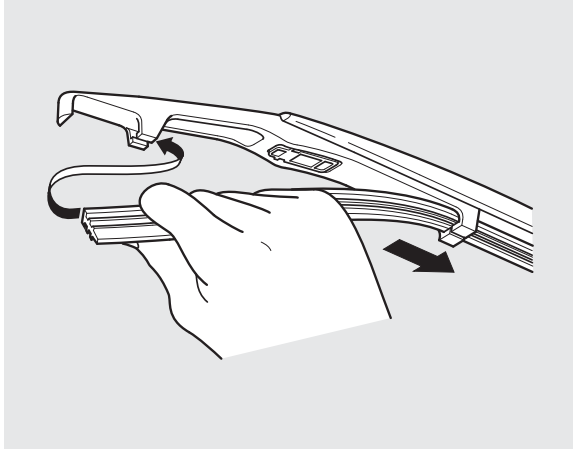

4. Slide the new blade into the wiper arm. Make sure it is engaged in the slot along its full length.
5. Lower the wiper arm.

Tires

To safely operate your vehicle, your tires must be the proper type and size, in good condition with adequate tread, and correctly inflated.

The following pages give more detailed information on how to take care of your tires and what to do when they need to be replaced.

WARNING

Using tires that are excessively worn or improperly inflated can cause a crash in which you can be seriously hurt or killed.

Follow all instructions in this owner's manual regarding tire inflation and maintenance.

Inflation Guidelines

Keeping the tires properly inflated provides the best combination of handling, tread life, and riding comfort.

- Underinflated tires wear unevenly, adversely affect handling and fuel economy, and are more likely to fail from being overheated.
- Overinflated tires can make your vehicle ride more harshly, are more prone to damage from road hazards, and wear unevenly.

The tire pressure monitoring system (TPMS) warns you when a tire pressure is low. See page 455 for more information.

Even though your vehicle is equipped with TPMS, we recommend that you visually check your tires every day. If you think a tire might be low, check it immediately with a tire gauge.

Use a gauge to measure the air pressure in each tire at least once a month. Even tires that are in good condition may lose 1 to 2 psi (10 to 20 kPa, 0.1 to 0.2 kgf/cm²) per month. Remember to check the spare tire at the same time.

Check the air pressures when the tires are cold. This means the vehicle has been parked for at least 3 hours, or driven less than 1 mile (1.6 km). Add or release air, if needed, to match the recommended cold tire pressures.

If you check air pressures when the tires are hot [driven for several miles (kilometers)], you will see readings 4 to 6 psi (30 to 40 kPa, 0.3 to 0.4 kgf/cm²) higher than the cold readings. This is normal. Do not let air out to match the recommended cold air pressure. The tire will be underinflated.

While tubeless tires have some ability to self-seal if they are punctured, you should look closely for punctures if a tire starts losing pressure.

You should get your own tire pressure gauge and use it whenever you check your tire pressures. This will make it easier for you to tell if a pressure loss is due to a tire problem and not due to a variation between gauges.

Recommended Tire Pressures

The following chart shows the recommended cold tire pressures for most normal driving conditions.

MDX, Technology Package, and U.S. Technology Package with Entertainment models

Tire Size	Cold Tire Pressure for Normal Driving
255/55R18 105H	Front/Rear: 32 psi (220 kPa, 2.2 kgf/cm ²)

U.S. Advance Package, Advance Package with Entertainment, and Canadian Elite Package models

Tire Size	Cold Tire Pressure for Normal Driving
P255/50R19 103H	Front/Rear: 32 psi (220 kPa, 2.2 kgf/cm ²)

The compact spare tire pressure is: 60 psi (420 kPa, 4.2 kgf/cm²)

For convenience, the recommended tire sizes and cold tire pressures are on a label on the driver's doorjamb.

For additional information about your tires, see page 581.

CONTINUED

Tires

High Speed Driving

We strongly recommend that you do not drive faster than the posted speed limits and conditions allow. If you ever drive in a sanctioned competitive event at sustained high speeds (over 99 mph or 160 km/h), be sure to adjust the cold tire pressures as shown below. If you do not, excessive heat can build up and cause sudden tire failure.

MDX, Technology Package, and U.S. Technology Package with Entertainment models

Tire Size	Cold Tire Pressure for High Speed Driving
255/55R18 105H	Front: 32 psi (220 kPa, 2.2 kgf/cm ²)
	Rear: 33 psi (230 kPa, 2.3 kgf/cm ²)

U.S. Advance Package, Advance Package with Entertainment, and Canadian Elite Package models

Tire Size	Cold Tire Pressure for High Speed Driving
P255/50R19 103H	Front: 33 psi (230 kPa, 2.3 kgf/cm ²)
	Rear: 36 psi (260 kPa, 2.6 kgf/cm ²)

Tire Inspection

Every time you check inflation, you should also examine the tires for damage, foreign objects, and wear.

You should look for:

- Bumps or bulges in the tread or side of the tire. Replace the tire if you find either of these conditions.
- Cuts, splits, or cracks in the side of the tire. Replace the tire if you can see fabric or cord.
- Excessive tread wear.

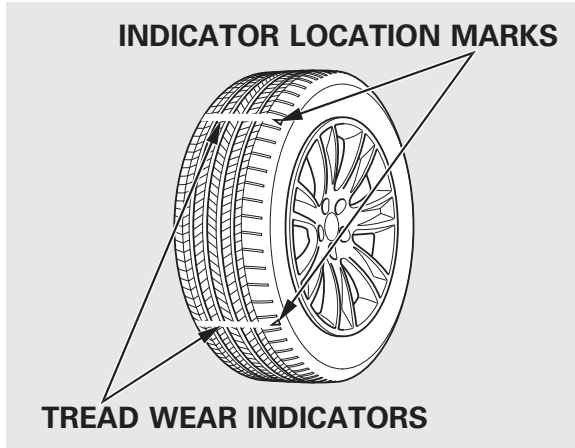

Your tires have wear indicators molded into the tread. When the tread wears down, you will see a 1/2 inch (12.7 mm) wide band across the tread. This shows there is less than 1/16 inch (1.6 mm) of tread left on the tire.

A tire this worn gives very little traction on wet roads. You should replace the tire if you can see three or more tread wear indicators.

Tire Service Life

The service life of your tires is dependent on many factors, including, but not limited to, driving habits, road conditions, vehicle loading, inflation pressure, maintenance history, speed, and environmental conditions (even when the tires are not in use).

In addition to your regular inspections and inflation pressure maintenance, it is recommended that you have annual inspections performed once the tires reach five years old. It is also recommended that all tires, including the spare, be removed from service after 10 years from the date of manufacture, regardless of their condition or state of wear.

The last four digits of the TIN (tire identification number) are found on the sidewall of the tire and indicate the date of manufacture (See **Tire Labeling** on page 583).

CONTINUED

Tires

Tire Maintenance

In addition to proper inflation, correct wheel alignment helps to decrease tire wear. If you find a tire is worn unevenly, have your dealer check the wheel alignment.

Have your dealer check the tires if you feel a consistent vibration while driving. A tire should always be rebalanced if it is removed from the wheel. When you have new tires installed, make sure they are balanced. This increases riding comfort and tire life. For best results, have the installer perform a dynamic balance.

NOTICE

Improper wheel weights can damage your vehicle's aluminum wheels. Use only Acura wheel weights for balancing.

Tire Rotation

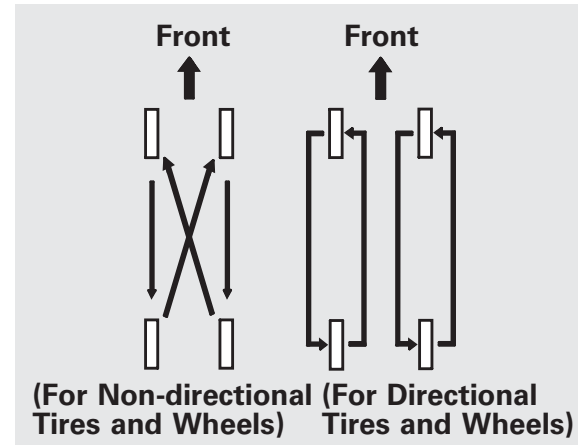

To help increase tire life and distribute wear more evenly, rotate the tires according to the maintenance messages displayed on the multi-information display. Move the tires to the positions shown in the illustration each time they are rotated. If you purchase directional tires, rotate only front-to-back.

Replacing Tires and Wheels

Replace your tires with radial tires of the same size, load range, speed rating, and maximum cold tire pressure rating (as shown on the tire's sidewall).

Mixing radial and bias-ply tires on your vehicle can reduce braking ability, traction, and steering accuracy. Using tires of a different size or construction can cause the ABS and vehicle stability assist system (VSA) to work inconsistently.

The ABS works by comparing the speed of the wheels. When replacing tires, use the same size originally supplied with the vehicle. Tire size and construction can affect wheel speed and may cause the system to activate.

It is best to replace all four tires at the same time. If that is not possible or necessary, replace the two front tires or two rear tires as a pair. Replacing just one tire can seriously affect your vehicle's handling.

If you ever replace a wheel, make sure that the wheel's specifications match those of the original wheels.

Also be sure you use only TPMS specific wheels. If you do not, the tire pressure monitoring system will not work.

Replacement wheels are available at your dealer.

⚠ WARNING

Installing improper tires on your vehicle can affect handling and stability. This can cause a crash in which you can be seriously hurt or killed.

Always use the size and type of tires recommended in this owner's manual.

Wheel and Tire Specifications

Wheel:

MDX, Technology Package, and U.S. Technology Package with Entertainment models

18 x 8 J (TPMS)

U.S. Advance Package, Advance Package with Entertainment, and Canadian Elite Package models

19 x 8 1/2 J (TPMS)

Tires:

MDX, Technology Package, and U.S. Technology Package with Entertainment models

255/55R18 105H

U.S. Advance Package, Advance Package with Entertainment, and Canadian Elite Package models

P255/50R19 103H

See page 581 for information about DOT Tire Quality Grading, and page 583 for tire size and labeling information.

Winter Driving

Tires marked “M + S” or “All Season” on the sidewall have an all-weather tread design suitable for most winter driving conditions.

For the best performance in snowy or icy conditions, you should install snow tires or tire chains. They may be required by local laws under certain conditions.

CONTINUED

Tires

Snow Tires

If you mount snow tires on your vehicle, make sure they are radial tires of the same size and load range as the original tires. Mount snow tires on all four wheels. The traction provided by snow tires on dry roads may be lower than your original tires. Check with the tire dealer for maximum speed recommendations.

Tire Chains

Mount tire chains on your tires when required by driving conditions or local laws. Install them only on the front tires.

Because your vehicle has limited tire clearance, Acura strongly recommends using the chains listed below.

SCC Super Z-6 # SC 435

When installing chains, follow the manufacturer's instructions and mount them as tightly as you can. Drive slowly with chains installed. If you hear them contacting the body or chassis, stop and investigate. Make sure the chains are installed tightly, and that they are not contacting the brake lines or suspension. Remove the chains as soon as you start driving on cleared roads.

WARNING

Using the wrong chains, or not properly installing chains, can damage the brake lines and cause a crash in which you can be seriously injured or killed.

Follow all instructions in this owner's manual regarding the selection and use of tire chains.

NOTICE

Traction devices that are the wrong size or improperly installed can damage your vehicle's brake lines, suspension, body, and wheels. Stop driving if they are hitting any part of the vehicle.

Wheels

Clean the wheels as you would the rest of the exterior. Wash them with the same solution, and rinse them thoroughly.

Aluminum alloy wheels have a protective clear-coat that keeps the aluminum from corroding and tarnishing. Cleaning the wheels with harsh chemicals (including some commercial wheel cleaners) or a stiff brush can damage the clear-coat. To clean the wheels, use a mild detergent and a soft brush or sponge.

The sensor on the negative terminal monitors your vehicle's battery condition.

If there is a problem with the sensor, you will see a "CHECK BATTERY SENSOR" message on the multi-information display. Have the vehicle checked by your dealer.

Check the terminals for corrosion (a white or yellowish powder). To remove it, cover the terminals with a solution of baking soda and water. It will bubble up and turn brown. When this stops, wash it off with plain water. Dry off the battery with a cloth or paper towel. Coat the terminals with grease to help prevent further corrosion.

If additional battery maintenance is needed, see your dealer or a qualified technician.

WARNING: Battery posts, terminals, and related accessories contain lead and lead compounds. **Wash your hands after handling.**

If you need to connect the battery to a charger, disconnect both cables to prevent damaging your vehicle's electrical system. Always disconnect the negative (–) cable first, and reconnect it last.

⚠ WARNING

The battery gives off explosive hydrogen gas during normal operation.

A spark or flame can cause the battery to explode with enough force to kill or seriously hurt you.

Wear protective clothing and a face shield, or have a skilled technician do the battery maintenance.

If the radio fuse is removed, the audio system will disable itself. The next time you turn on the radio you will see "ENTER CODE" in the frequency display. Use the preset buttons to enter the digit code (see page 308).

Vehicle Storage

If you need to park your vehicle for an extended period (more than 1 month), there are several things you should do to prepare it for storage. Proper preparation helps prevent deterioration and makes it easier to get your vehicle back on the road. If possible, store your vehicle indoors.

- Fill the fuel tank.
 - Wash and dry the exterior completely.
 - Clean the interior. Make sure the carpeting, floor mats, etc., are completely dry.
 - Leave the parking brake off. Put the transmission in Park.
- Block the rear wheels.
 - If the vehicle is to be stored for a longer period, it should be supported on jackstands so the tires are off the ground.
 - Leave one window open slightly (if the vehicle is being stored indoors).
 - Disconnect the battery.
 - Support the front and rear wiper blade arms with a folded towel or rag so they do not touch the windshield.
 - To minimize sticking, apply a silicone spray lubricant to all door and tailgate seals. Also, apply a vehicle body wax to the painted surfaces that mate with the door and tailgate seals.
- Cover the vehicle with a “breathable” cover, one made from a porous material such as cotton. Non-porous materials, such as plastic sheeting, trap moisture, which can damage the paint.
 - If possible, periodically run the engine until it reaches full operating temperature (the cooling fans cycle on and off twice). Preferably, do this once a month.

This section covers the more common problems that motorists experience with their vehicles. It gives you information about how to safely evaluate the problem and what to do to correct it. If the problem has stranded you on the side of the road, you may be able to get going again. If not, you will also find instructions on getting your vehicle towed.

- Compact Spare Tire 550
- Changing a Flat Tire 551
- If the Engine Won't Start..... 557
- Jump Starting..... 558
- If the Engine Overheats 560
- Low Oil Pressure Indicator 562
- Charging System Indicator 562
- Malfunction Indicator Lamp 563
- Brake System Indicator..... 564
- Fuses 565
- Fuse Locations..... 569
- Opening the Fuel Fill Door
 - Manually..... 572
- Emergency Towing..... 572
- If Your Vehicle Gets Stuck 573

Compact Spare Tire

Use the compact spare tire as a temporary replacement only. Get your regular tire repaired or replaced, and put it back on your vehicle as soon as you can.

Check the inflation pressure of the compact spare tire every time you check the other tires. It should be inflated to:

60 psi (420 kPa, 4.2 kgf/cm²)

Follow these precautions:

- Never exceed 50 mph (80 km/h).
- This tire gives a harsher ride and less traction on some road surfaces. Use greater caution while driving.

- Do not mount snow chains on a compact spare.
- Do not use your compact spare tire on another vehicle unless it is the same make and model.
- After the flat tire is replaced with the spare tire, the low tire pressure/TPMS indicator stays on. After several miles (kilometers) driving with the spare, this indicator begins to flash, then stays on again. You will also see a “CHECK TPMS SYSTEM” message on the multi-information display (see page 458).

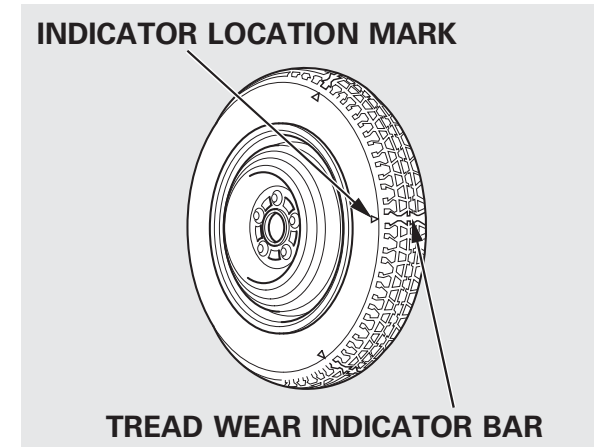

Replace the tire when you can see the tread wear indicator bars. The replacement should be the same size and design tire, mounted on the same wheel. The spare tire is not designed to be mounted on a regular wheel, and the spare wheel is not designed for mounting a regular tire.

Changing a Flat Tire

If you have a flat tire while driving, stop in a safe place to change it. Drive slowly along the shoulder until you get to an exit or an area to stop that is far away from the traffic lanes.

⚠ WARNING

The vehicle can easily roll off the jack, seriously injuring anyone underneath.

Follow the directions for changing a tire exactly, and never get under the vehicle when it is supported only by the jack.

1. Park the vehicle on firm, level, and non-slippery ground. Put the transmission in Park. Apply the parking brake.

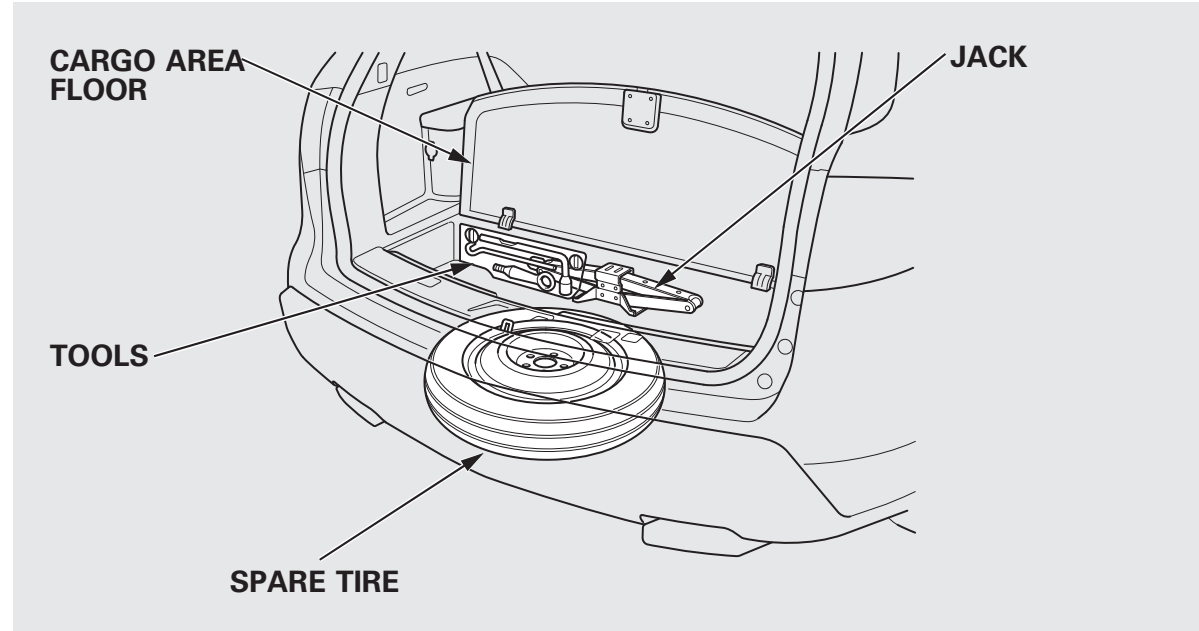

2. Turn on the hazard warning lights, and turn the ignition switch to the LOCK (0) position. Have all passengers get out of the vehicle while you change the tire.
3. Open the tailgate.
4. Push the rear edge of the handle to raise the handle loop and pull up the loop to raise the cargo area floor.

CONTINUED

Changing a Flat Tire

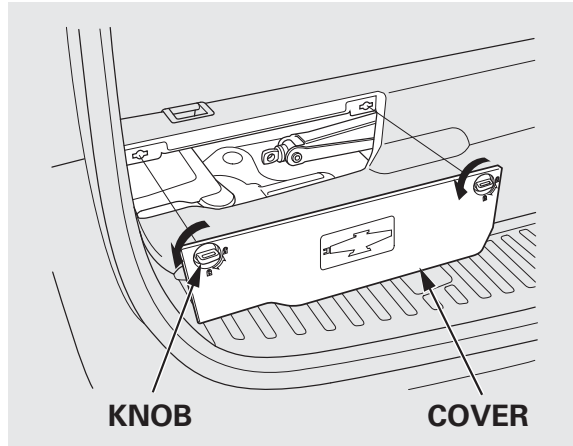

5. The tools and jack are under the cargo area behind a cover on the driver's side. Remove the cover by turning the knobs counterclockwise, then pulling out the cover.

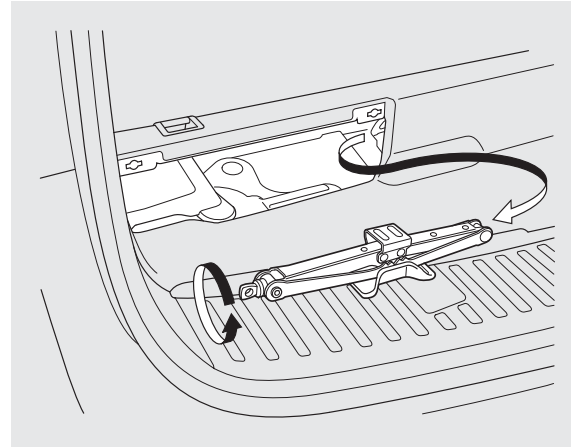

6. Turn the jack's end bracket counterclockwise to loosen it, then remove the jack.

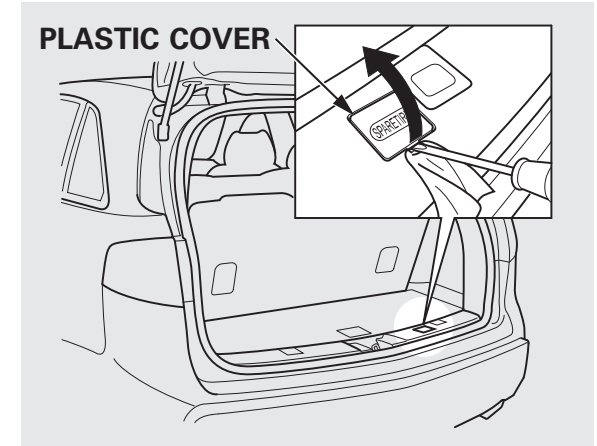

7. The spare tire is stored underneath the rear cargo area. Remove the plastic cover on the cargo area lining to access the shaft for the spare tire hoist.

Changing a Flat Tire

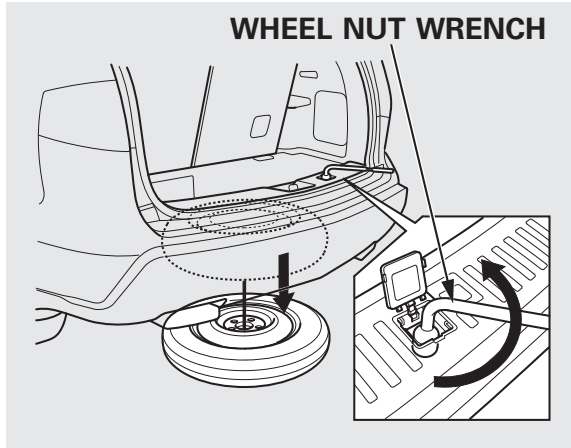

NOTICE

The wheel nut wrench supplied with your vehicle is specially adapted to fit the hoist shaft. Do not use any other tool.

- Put the wheel nut wrench on the hoist shaft. Turn the wrench counterclockwise to lower the spare tire to the ground.

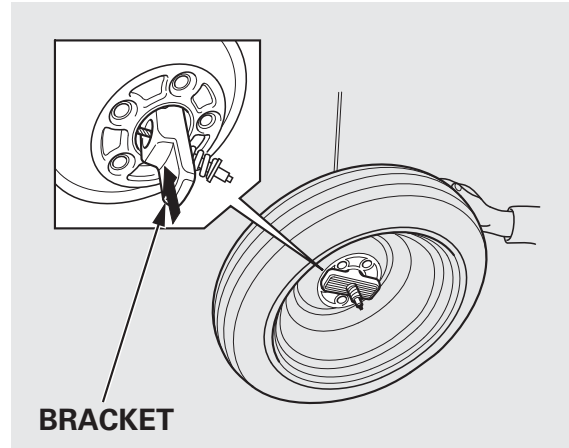

- Keep turning the wheel nut wrench to create slack in the cable.
- Remove the bracket from the spare tire.

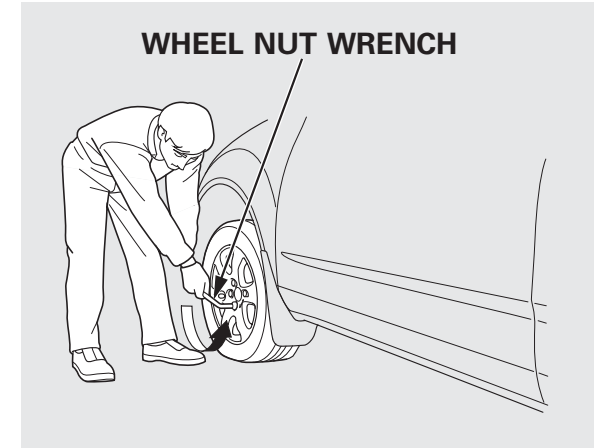

- Loosen each wheel nut 1/2 turn with the wheel nut wrench.

CONTINUED

Changing a Flat Tire

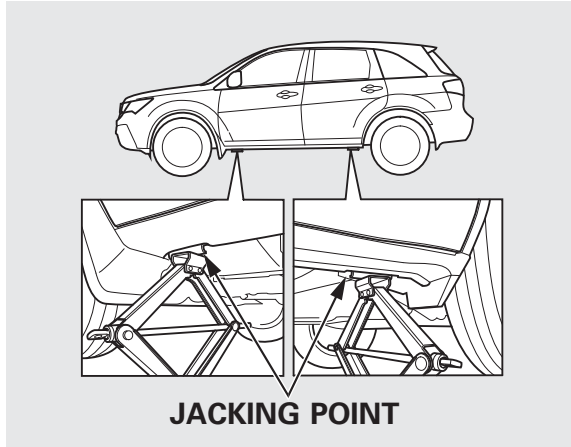

12. Place the jack under the jacking point nearest the tire you need to change. Turn the end bracket clockwise until the top of the jack contacts the jacking point. Make sure the jacking point tab is resting in the jack notch.

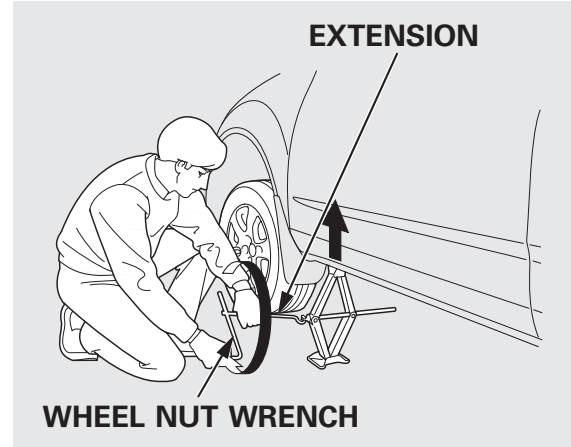

13. Use the extension and the wheel nut wrench as shown to raise the vehicle until the flat tire is off the ground.
14. Remove the wheel nuts, then remove the flat tire.

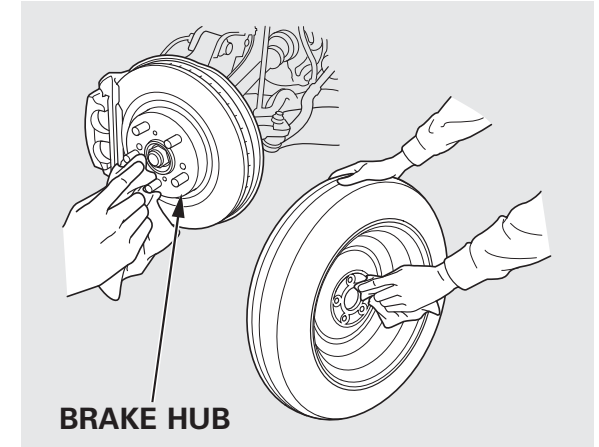

15. Before mounting the spare tire, wipe any dirt off the mounting surface of the wheel and hub with a clean cloth. Wipe the hub carefully; it may be hot from driving.

Changing a Flat Tire

- Put on the spare tire. Put the wheel nuts back on finger-tight, then tighten them in a crisscross pattern with the wheel nut wrench until the wheel is firmly against the hub. Do not try to tighten the wheel nuts fully.
- Lower the vehicle to the ground, and remove the jack.

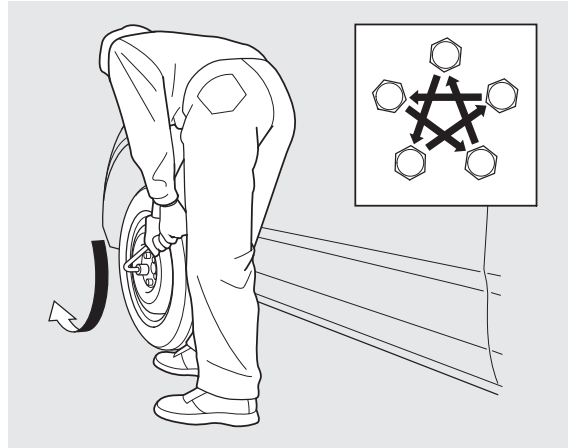

- Tighten the wheel nuts securely in the same crisscross pattern. Have the wheel nut torque checked at the nearest automotive service facility.
Tighten the wheel nuts to:
94 lbf·ft (127 N·m, 13 kgf·m)
- Remove the center cap from the flat tire.

- Place the flat tire face up under the hoist.
- Insert the hoist bracket into the center hole of the flat tire.

CONTINUED

Changing a Flat Tire

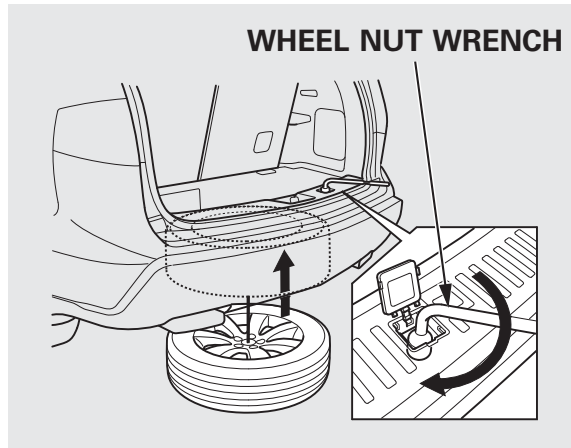

22. Slowly turn the wheel nut wrench clockwise to take up the slack of the hoist cable. Make sure the bracket is seated in the center hole of the flat tire.
23. Turn the wheel nut wrench clockwise until the flat tire rests against the underbody of the vehicle and you hear the hoist click.

NOTICE

Always raise the spare tire hoist, even if you are not stowing a tire. If the hoist is left down, it will be damaged during driving and need to be replaced.

24. Store the jack in its holder. Turn the jack's end bracket to lock it in place. Store the tools, and install the cover.
25. Refer to **Changing a Tire with TPMS** (see page 459).

⚠ WARNING

Loose items can fly around the interior in a crash and could seriously injure the occupants.

Store the wheel, jack, and tools securely before driving.

Diagnosing why the engine won't start falls into two areas, depending on what you hear when you turn the ignition switch to the START (III) position:

- You hear nothing, or almost nothing. The engine's starter motor does not operate at all, or operates very slowly.
- You can hear the starter motor operating normally, or the starter motor sounds like it is spinning faster than normal, but the engine does not start up and run.

Nothing Happens or the Starter Motor Operates Very Slowly

When you turn the ignition switch to the START (III) position, you do not hear the normal noise of the engine trying to start. You may hear a clicking sound, a series of clicks, or nothing at all.

Check these things:

- Check the transmission interlock. The transmission must be in Park or neutral or the starter will not operate.
- Turn the ignition switch to the ON (II) position. Turn on the headlights, and check their brightness. If the headlights are very dim or do not come on at all, the battery is discharged. See **Jump Starting** on page 558.
- Turn the ignition switch to the START (III) position. If the headlights do not dim, check the condition of the fuses. If the fuses are OK, there is probably something wrong with the electrical circuit for the ignition switch or starter motor. You will need a qualified technician to determine the problem. See **Emergency Towing** on page 572.

If the headlights dim noticeably or go out when you try to start the engine, either the battery is discharged or the connections are corroded. Check the condition of the battery and terminal connections (see page 547). You can then try jump starting the vehicle from a booster battery (see page 558).

The Starter Operates Normally

In this case, the starter motor's speed sounds normal, or even faster than normal, when you turn the ignition switch to the START (III) position, but the engine does not run.

- Are you using a properly coded key? An improperly coded key will cause the immobilizer system indicator in the instrument panel to blink rapidly (see page 74).

CONTINUED

If the Engine Won't Start, Jump Starting

- Are you using the proper starting procedure? Refer to **Starting the Engine** on page 442.
- Do you have fuel? Check the fuel gauge; the warning indicator may not be working.
- There may be an electrical problem, such as no power to the fuel pump. Check all the fuses (see page 566).

If you find nothing wrong, you will need a qualified technician to find the problem. See **Emergency Towing** on page 572.

Jump Starting

Although this seems like a simple procedure, you should take several precautions.

⚠ WARNING

A battery can explode if you do not follow the correct procedure, seriously injuring anyone nearby.

Keep all sparks, open flames, and smoking materials away from the battery.

You cannot start your vehicle by pushing or pulling it.

To Jump Start Your Vehicle:

1. Open the hood, and check the physical condition of the battery. In very cold weather, check the condition of the electrolyte. If it seems slushy or frozen, do not try jump starting until it thaws.

NOTICE

If a battery sits in extreme cold, the electrolyte inside can freeze. Attempting to jump start with a frozen battery can cause it to rupture.

2. Turn off all the electrical accessories: heater, A/C, climate control, audio system, lights, etc. Put the transmission in neutral or Park, and set the parking brake.

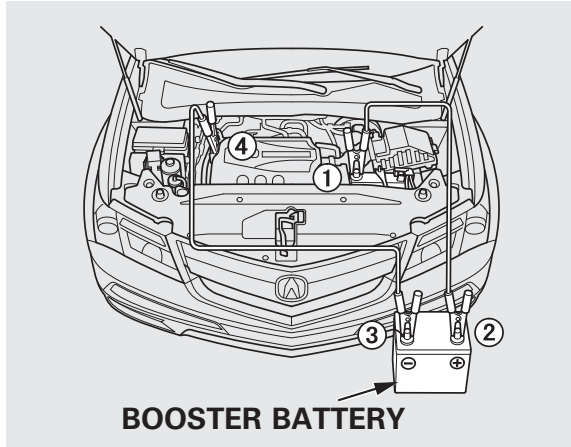

The numbers in the illustration show you the order to connect the jumper cables.

3. Connect one jumper cable to the positive (+) terminal on your vehicle's battery. Connect the other end to the positive (+) terminal on the booster battery.

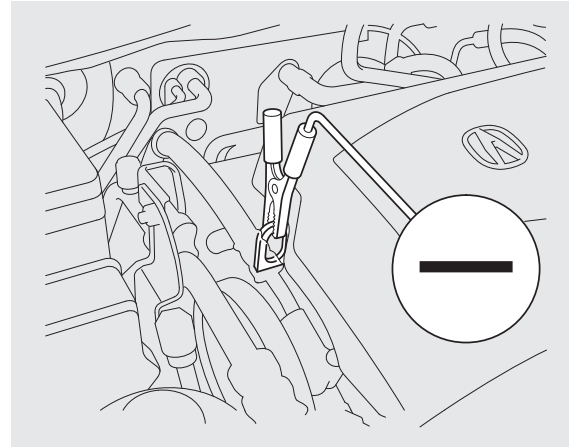

4. Connect the second jumper cable to the negative (-) terminal on the booster battery. Connect the other end to the grounding point as shown. Do not connect this jumper cable to any other part of the engine.

5. If the booster battery is in another vehicle, have an assistant start that vehicle and run it at a fast idle.
6. Start your vehicle. If the starter motor still operates slowly, check that the jumper cables have good metal-to-metal contact.
7. Once the vehicle is running, disconnect the negative cable from your vehicle, then from the booster battery. Disconnect the positive cable from your vehicle, and then from the booster battery.

Keep the ends of the jumper cables away from each other and any metal on the vehicle until everything is disconnected. Otherwise, you may cause an electrical short.

If the Engine Overheats

The pointer of your vehicle's temperature gauge should stay in the midrange under most conditions. If it climbs to the red mark, you should determine the reason (hot day, driving up a steep hill, etc.).

If the vehicle overheats, you should take immediate action. The only indication may be the temperature gauge climbing to or above the red mark. Or you may see steam or spray coming from under the hood.

NOTICE

Driving with the temperature gauge pointer at the red mark can cause serious damage to the engine.

⚠ WARNING

Steam and spray from an overheated engine can seriously scald you.

Do not open the hood if steam is coming out.

1. Safely pull to the side of the road. Put the transmission in Park, and set the parking brake. Turn off all accessories, and turn on the hazard warning indicators.
2. If you see steam and/or spray coming from under the hood, turn off the engine. Wait until you see no more signs of steam or spray, then open the hood.
3. If you do not see steam or spray, leave the engine running and watch the temperature gauge. If the high heat is due to overloading, the engine should start to cool down almost immediately. If it does, wait until the temperature gauge comes down to the midpoint, then continue driving.

4. If the temperature gauge stays at the red mark, turn off the engine.
5. Look for any obvious coolant leaks, such as a split radiator hose. Everything is still extremely hot, so use caution. If you find a leak, it must be repaired before you continue driving (see **Emergency Towing** on page 572).
6. If you do not find an obvious leak, check the coolant level in the radiator reserve tank. Add coolant if the level is below the MIN mark.
7. If there was no coolant in the reserve tank, you may need to add coolant to the radiator. Let the engine cool down until the pointer reaches the middle of the temperature gauge, or lower, before checking the radiator.

⚠ WARNING

Removing the radiator cap while the engine is hot can cause the coolant to spray out, seriously scalding you.

Always let the engine and radiator cool down before removing the radiator cap.

8. Using gloves or a large heavy cloth, turn the radiator cap counterclockwise, without pushing down, to the first stop. After the pressure releases, push down on the cap, and turn it until it comes off.
9. Start the engine and set the climate control to AUTO at “Hi.” Add coolant to the radiator up to the base of the filler neck. If you do not have the proper coolant mixture available, you can add plain water. Remember to have the cooling system drained and refilled with the proper mixture as soon as you can.
10. Put the radiator cap back on tightly. Run the engine, and check the temperature gauge. If it goes back to the red mark, the engine needs repair (see **Emergency Towing** on page 572).
11. If the temperature stays normal, check the coolant level in the radiator reserve tank. If it has gone down, add coolant to the MAX mark. Put the cap back on tightly.

Low Oil Pressure Indicator, Charging System Indicator

Low Oil Pressure Indicator



This indicator should never come on when the engine is running. If it starts flashing or stays on, the oil pressure has dropped very low or lost pressure. Serious engine damage is possible, and you should take immediate action.

You will also see a “CHECK ENGINE OIL LEVEL” message on the multi-information display when this indicator comes on.

NOTICE

Running the engine with low oil pressure can cause serious mechanical damage almost immediately. Turn off the engine as soon as you can safely get the vehicle stopped.

1. Safely pull off the road, and shut off the engine. Turn on the hazard warning indicators.
2. Let the vehicle sit for a minute. Open the hood, and check the oil level (see page 427). An engine very low on oil can lose pressure during cornering and other driving maneuvers.
3. If necessary, add oil to bring the level back to the full mark on the dipstick (see page 517).
4. Start the engine, and watch the oil pressure indicator. If it does not go out within 10 seconds, turn off the engine. There is a mechanical problem that needs to be repaired before you can continue driving (see **Emergency Towing** on page 572).

Charging System Indicator



If the charging system indicator comes on brightly when the engine is running, the battery is not being charged.

You will also see a “CHECK CHARGING SYSTEM” message on the multi-information display (see page 87).

Immediately turn off all electrical accessories. Try not to use other electrically operated controls such as the power windows. Keep the engine running; starting the engine will discharge the battery rapidly.

Go to a service station or garage where you can get technical assistance.

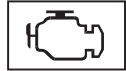

If this indicator comes on while driving, it means one of the engine's emissions control systems may have a problem. Even though you may feel no difference in your vehicle's performance, it can reduce your fuel economy and cause increased emissions. Continued operation may cause serious damage.

If you have recently refueled your vehicle, the indicator coming on could be due to a loose or missing fuel fill cap. Tighten the cap until it clicks at least once. Tightening the cap will not turn the indicator off immediately; it can take several days of normal driving.

If the indicator comes on repeatedly, even though it may turn off as you continue driving, have your vehicle checked by the dealer as soon as possible.

NOTICE

If you keep driving with the malfunction indicator lamp on, you can damage your vehicle's emissions controls and engine. Those repairs may not be covered by your vehicle's warranties.

You will also see a “CHECK EMISSION SYSTEM” message on the multi-information display (see page 87).

Readiness Code

Your vehicle has certain “readiness codes” that are part of the on-board diagnostics for the emissions systems. In some states, part of the emissions testing is to make sure these codes are set. If they are not set, the test cannot be completed.

If the battery in your vehicle has been disconnected or gone dead, these codes may be erased. It takes several days of driving under various conditions to set the codes again.

To check if they are set, turn the ignition switch to the ON (II) position, without starting the engine. The malfunction indicator lamp will come on for 20 seconds. If it then goes off, the readiness codes are set. If it blinks five times, the readiness codes are not set. If possible, do not take your vehicle for an emissions test until the readiness codes are set. Refer to **Emissions Testing** for more information (see page 590).

Brake System Indicator

U.S.

Canada



The brake system indicator normally comes on when you turn the ignition switch to the ON (II) position, and as a reminder to check the parking brake. It will stay on if you do not fully release the parking brake.

If the brake system indicator comes on while driving, the brake fluid level is probably low. Press lightly on the brake pedal to see if it feels normal. If it does, check the brake fluid level the next time you stop at a service station (see page 525).

You will also see a “LOW BRAKE FLUID” message on the multi-information display (see page 87).

If the fluid level is low, take your vehicle to a dealer, and have the brake system inspected for leaks or worn brake pads.

However, if the brake pedal does not feel normal, you should take immediate action. A problem in one part of the system's dual circuit design will still give you braking at two wheels. You will feel the brake pedal go down much farther before the vehicle begins to slow down, and you will have to press harder on the pedal.

You will also see a “CHECK BRAKE SYSTEM” message on the multi-information display (see page 87).

Slow down by shifting to a lower gear, and pull to the side of the road when it is safe. Because of the long distance needed to stop, it is hazardous to drive the vehicle. You should have it towed, and repaired as soon as possible (see **Emergency Towing** on page 572).

If you must drive the vehicle a short distance in this condition, drive slowly and carefully.

If the ABS indicator and the VSA system indicator come on with the brake system indicator, have your vehicle inspected by your dealer immediately.

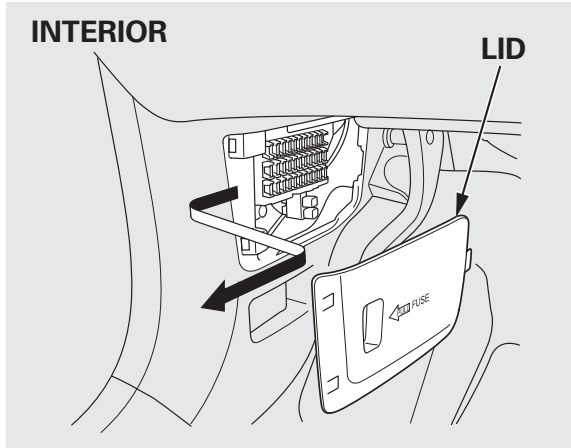

The vehicle's fuses are located in four fuse boxes.

The interior fuse box is underneath the dashboard on the driver's side.

To remove the fuse box lid, put your finger in the notch on the lid, pull it toward you, and take it out of its hinges.

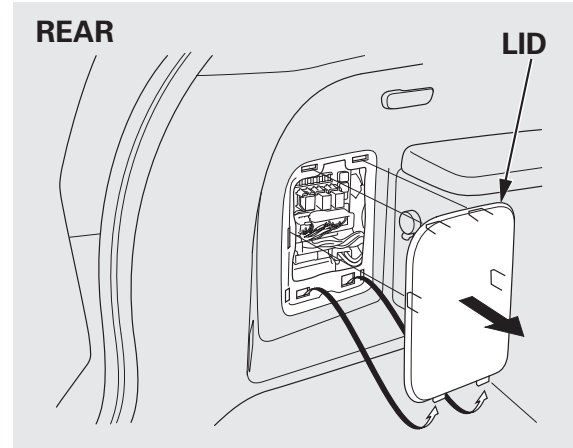

The rear fuse box is located at the left side of the cargo area.

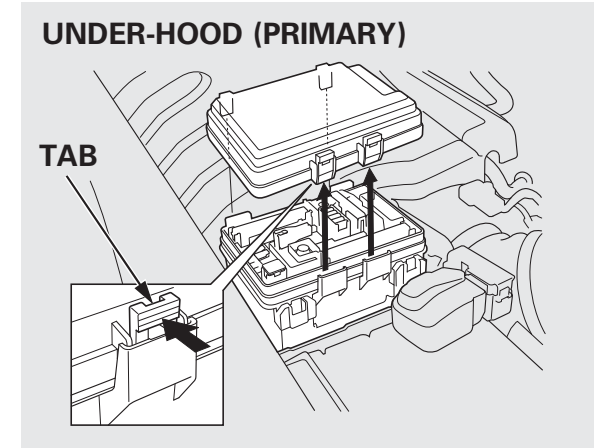

The primary under-hood fuse box is located next to the battery.

To open it, push the tabs as shown.

CONTINUED

Fuses

UNDER-HOOD (SECONDARY)

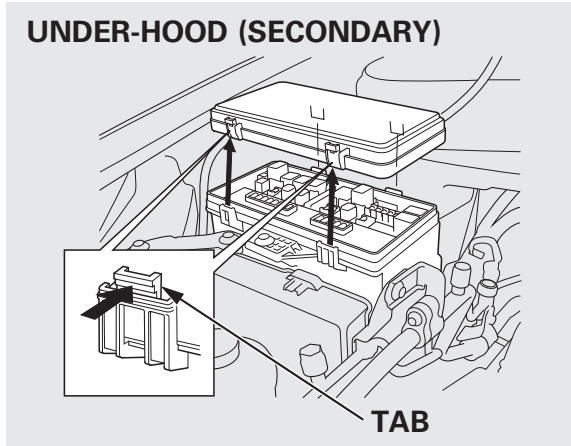

The secondary fuse box is on the passenger's side.

To open it, push the tabs as shown.

UNDER-HOOD (SUB)

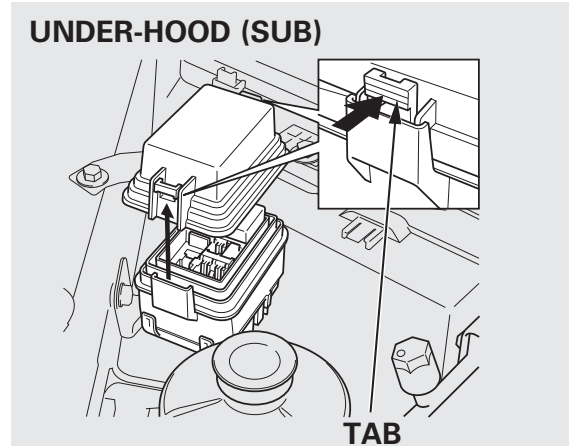

If equipped

The sub fuse box is on the passenger's side.

To open it, push the tabs as shown.

Checking and Replacing Fuses

If something electrical in your vehicle stops working, the first thing you should check for is a blown fuse. Determine from the chart on pages 569, 570, and 571, or the diagram on the fuse box lid, which fuse or fuses control that device. Check those fuses first, but check all the fuses before deciding that a blown fuse is the cause. Replace any blown fuses, and check if the device works.

1. Turn the ignition switch to the LOCK (0) position. Make sure the headlights and all other accessories are off.
2. Remove the cover from the fuse box.

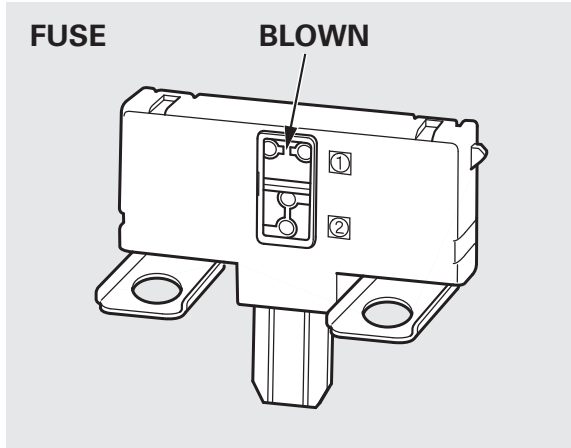

3. Check each of the large fuses in the under-hood fuse boxes by looking through the top at the wire inside. Removing these fuses requires a Phillips-head screwdriver.

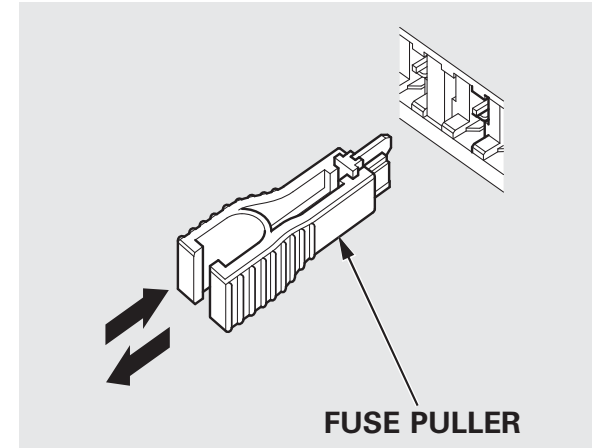
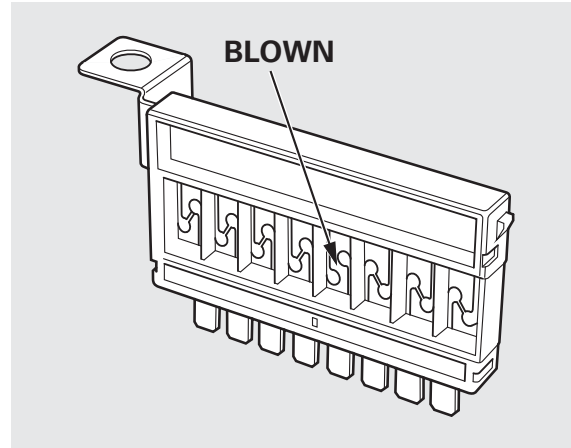

4. Check the smaller fuses in the under-hood fuse boxes and rear fuse box, and all the fuses in the interior and rear fuse boxes by pulling out each one with the fuse puller provided in the primary under-hood fuse box.

CONTINUED

Fuses

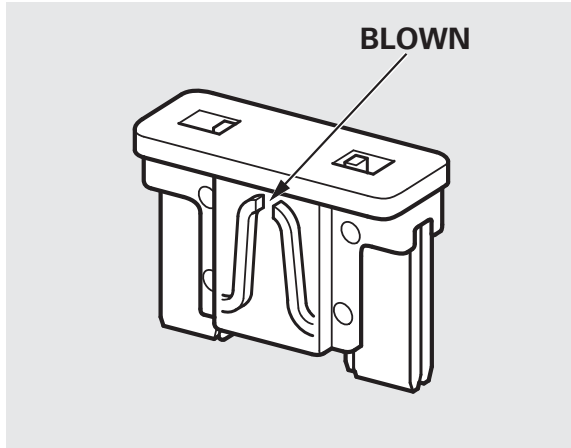

5. Look for a burned wire inside the fuse. If it is burned out, replace it with one of the spare fuses of the same rating or lower.

If you cannot drive the vehicle without fixing the problem, and you do not have a spare fuse, take a fuse of the same rating or a lower rating from one of the other circuits. Make sure you can do without that circuit temporarily (such as the accessory power socket or radio).

If you replace the blown fuse with a spare fuse that has a lower rating, it might blow out again. This does not indicate that anything is wrong. Replace the fuse with one of the correct rating as soon as you can.

NOTICE

Replacing a fuse with one that has a higher rating greatly increases the chances of damaging the electrical system. If you do not have a replacement fuse with the proper rating for the circuit, install one with a lower rating.

6. If the replacement fuse of the same rating blows in a short time, there is probably a serious electrical problem with your vehicle. Leave the blown fuse in that circuit, and have your vehicle checked by a qualified technician.

Fuse Locations

PRIMARY UNDER-HOOD FUSE BOX

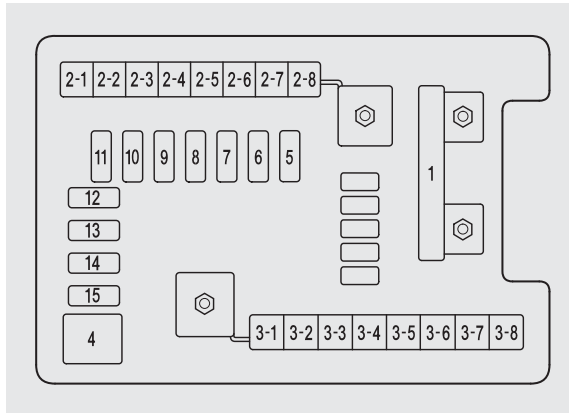

No.	Amps.	Circuits Protected
1	120 A	Main fuse
	–	Not Used
2-1	30 A	ADS* ²
2-2	30 A	SH-AWD
2-3	30 A	Rear Blower Motor
2-4	40 A	ABS VSA
2-5	40 A	Trailer Main
2-6	40 A	Power Seats, Driver's Position Memory System, Subwoofer, Telescopic Steering Wheel
2-7	40 A	Front Heated Seat, TPMS, Moonroof, Driver's Lumbar Support
2-8	–	–
3-1	60 A	Fog Lights, Front Blower Motor, Interior Light
3-2	40 A	Headlights, Daytime Running Lights
3-3	60 A	Cooling Fan, Condenser Fan, MG Clutch, Headlight Washer* ¹
3-4	50 A	Ignition Switch Main

* 1: Canadian model

* 2: If equipped

No.	Amps.	Circuits Protected
3-5	50 A	Power Window
3-6	60 A	Power Tailgate Opener/Closer, Rear ACC Socket, Interior Light, Rear Defroster
3-7	30 A	ECU (PCM)
3-8	30 A	TECH
4	40 A	Audio, Door Lock, Interior Lights, Front ACC Socket
5	30 A	EPT-L* ²
6	30 A	EPT-R* ²
7	30 A	FI ECU
8	30 A	Audio Amplifier
9	7.5 A	Battery Sensor
10	15 A	Hazard
11	15 A	Horn, Stop
12	20 A	ABS VSA
13	20 A	Trailer (Brake)
14	20 A	Rear Heated Seat* ²
15	20 A	A/C Inverter

CONTINUED

Fuse Locations

SECONDARY UNDER-HOOD FUSE BOX

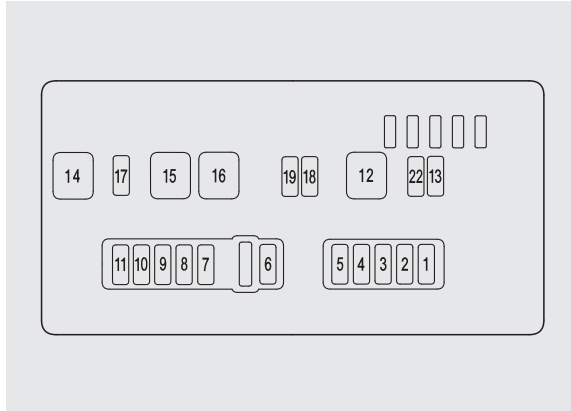

No.	Amps.	Circuits Protected
1	10 A	Left Daytime Running Light
2	10 A	Right Daytime Running Light
3	10 A	Left Headlight High
4	10 A	Right Headlight High
5	7.5 A	Small Lights (Exterior)
6	30 A	Headlight Low Main
7	7.5 A	Cooling Fan Timer
8	15 A	IGP
9	15 A	IG Coil
10	15 A	DBW
11	15 A	AFHT
12	40 A	Front Blower Motor

No.	Amps.	Circuits Protected
13	20 A	Fog Lights
14	30 A	Headlight Washer*
15	30 A	Condenser Fan
16	30 A	Cooling Fan
17	7.5 A	A/C Clutch
18	15 A	Left Headlight Low
19	15 A	Right Headlight Low
22	7.5 A	Small Lights (Interior)

*: Canadian model

SUB FUSE BOX

If equipped

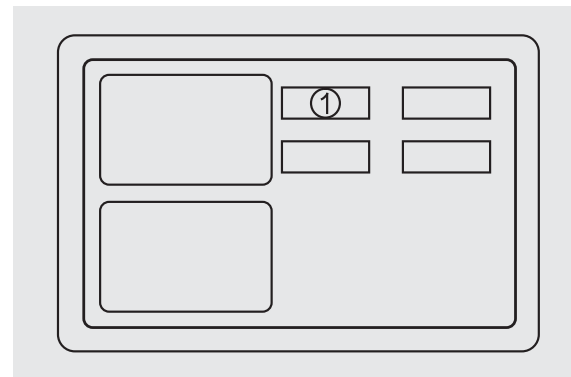

No.	Amps.	Circuits Protected
1	10 A	ACC/CMBS, BSI, ADS, EPT, AVS

REAR FUSE BOX

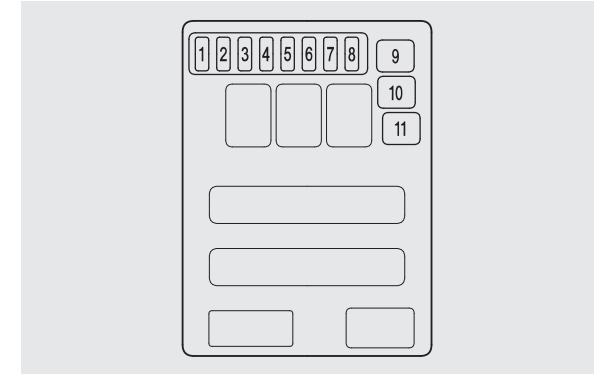

No.	Amps.	Circuits Protected
1	-	Not Used
2	-	Not Used
3	-	Not Used
4	-	Not Used
5	10 A	Rear ACC Socket
6	20 A	Power Tailgate
7	-	Not Used
8	7.5 A	Interior Light
9	-	Not Used
10	30 A	Rear Defroster
11	40 A	Power Tailgate

Fuse Locations

INTERIOR FUSE BOX

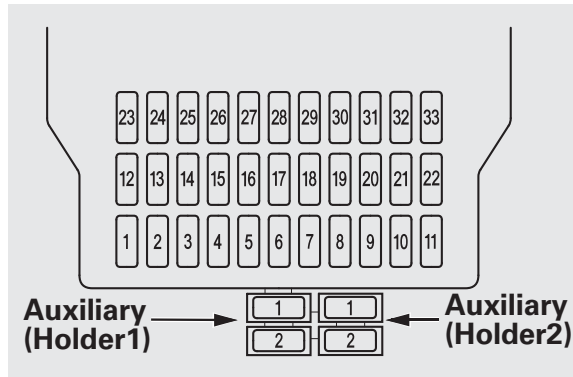

No.	Amps.	Circuits Protected
1	7.5 A	TPMS
2	10 A	Driver's Lumbar Support Motor
3	15 A	Moonroof
4	20 A	Front Heated Seats
5	10 A	Audio
6	7.5 A	Interior Light
7	10 A	Back Up
8	20 A	Door Lock
9	15 A	ACC Socket
10	15 A	IG Coil
11	30 A	Windshield Wiper
12	10 A	Subwoofer
13	20 A	Passenger's Power Recline

No.	Amps.	Circuits Protected
14	20 A	Driver's Power Slide
15	20 A	Telescopic Steering Wheel
16	20 A	Driver's Power Recline
17	20 A	Passenger's Power Slide
18	10 A	Alternator
19	20 A	Fuel Pump
20	10 A	SH-AWD, ODS
21	7.5 A	Gauges
22	10 A	SRS
23	-	Not Used
24	20 A	Left Rear Power Window
25	20 A	Right Rear Power Window
26	30 A	Passenger's Power Window
27	30 A	Driver's Power Window
28	20 A	Tilt Steering Wheel
29	10 A	ABS VSA
30	10 A	A/C
31	15 A	Washer
32	10 A	ACC
33	-	Not Used

Auxiliary (Holder1)

No.	Amps.	Circuits Protected
1	7.5 A	Starter DIAG
2	7.5 A	SH-AWD

Auxiliary (Holder2)

No.	Amps.	Circuits Protected
1	7.5 A	STS
2	7.5 A	ODS

Opening the Fuel Fill Door Manually, Emergency Towing

Opening the Fuel Fill Door Manually

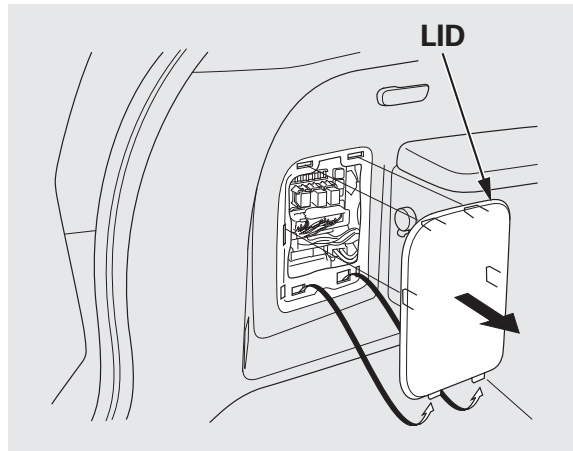

If the fuel fill door release button does not work, use the release lever inside the rear fuse box lid in the cargo area.

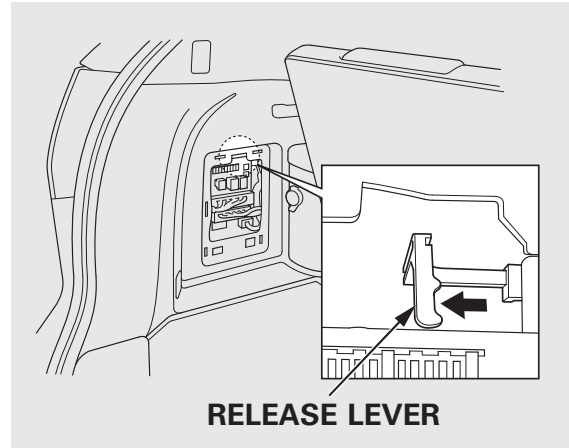

To open the fuel fill door, pull the release lever rearward.

Emergency Towing

If your vehicle needs to be towed, call a professional towing service or organization. Never tow your vehicle with just a rope or chain. It is very dangerous.

The only way you can safely tow your vehicle is with flat-bed equipment. The operator will load your vehicle on the back of a truck. Any other method of towing will damage the drive system. When you contact the towing agency, inform them a flat-bed is required.

NOTICE

Towing with only two tires on the ground will damage parts of the all-wheel-drive system. Your vehicle should be transported on a flat-bed truck or trailer.

If Your Vehicle Gets Stuck

If your vehicle gets stuck in sand, mud, or snow, call a towing service to pull it out (see the previous page).

For very short distances, such as freeing the vehicle, you can use the detachable towing hook that mounts on the anchors in the front and rear bumpers.

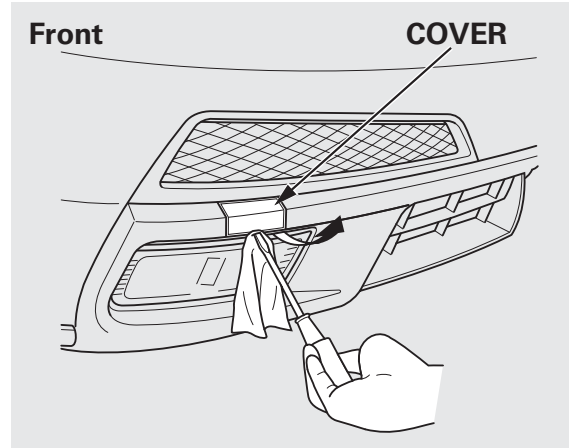

1. Remove the cover, put cloth on the edge of the cover to prevent scratches and carefully pry with a small flat-tip screwdriver or a metal fingernail file.

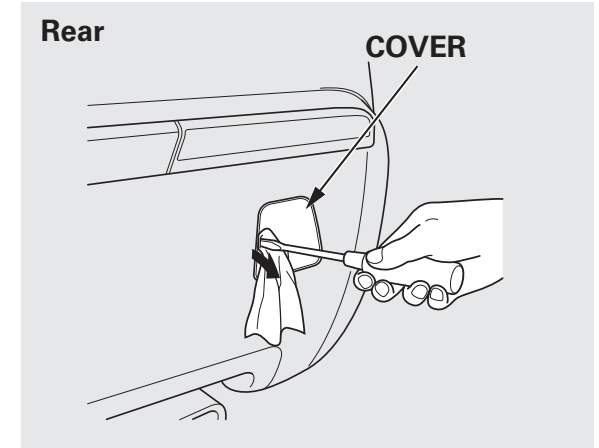

The cover is attached to the bumper with a tether.

CONTINUED

If Your Vehicle Gets Stuck

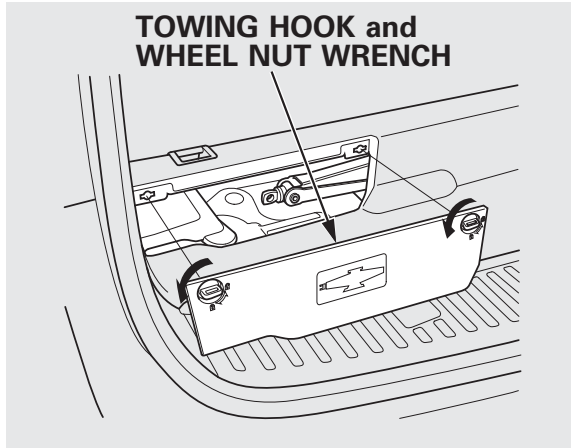

2. Remove the towing hook and wheel nut wrench located behind the cargo area cover on the driver's side.

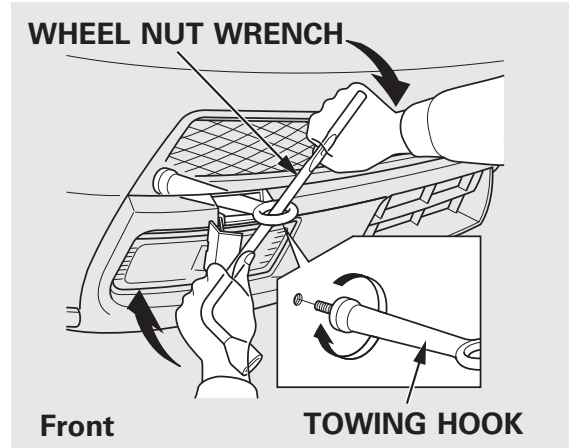

3. Screw the towing hook into the hole, and tighten it with the wheel nut wrench.

NOTICE

To avoid damage to your vehicle, use the towing hook for straight, flat ground towing only. Do not tow at an angle. The tow hook should not be used to tow the vehicle onto a flat bed. Do not use it as a tie down.

The diagrams in this section give you the dimensions and capacities of your vehicle and the locations of the identification numbers. It also includes information you should know about your vehicle's tires and emissions control systems.

- Identification Numbers 576
- Specifications 578
- DOT Tire Quality Grading (U.S. Vehicles) 581
- Tire Labeling 583
- Tire Pressure Monitoring System (TPMS) – Required Federal Explanation 585
- Emissions Controls 587
- Three Way Catalytic Converter 589
- Emissions Testing 590

Identification Numbers

Your vehicle has several identifying numbers located in various places.

The vehicle identification number (VIN) is the 17-digit number your dealer uses to register your vehicle for warranty purposes. It is also necessary for licensing and insuring your vehicle. The easiest place to find the VIN is on a plate fastened to the top of the dashboard. You can see it by looking through the windshield on the driver's side. It is also on the certification label attached to the driver's doorjamb, and is stamped on the engine compartment bulkhead. The VIN is also provided in bar code on the certification label.

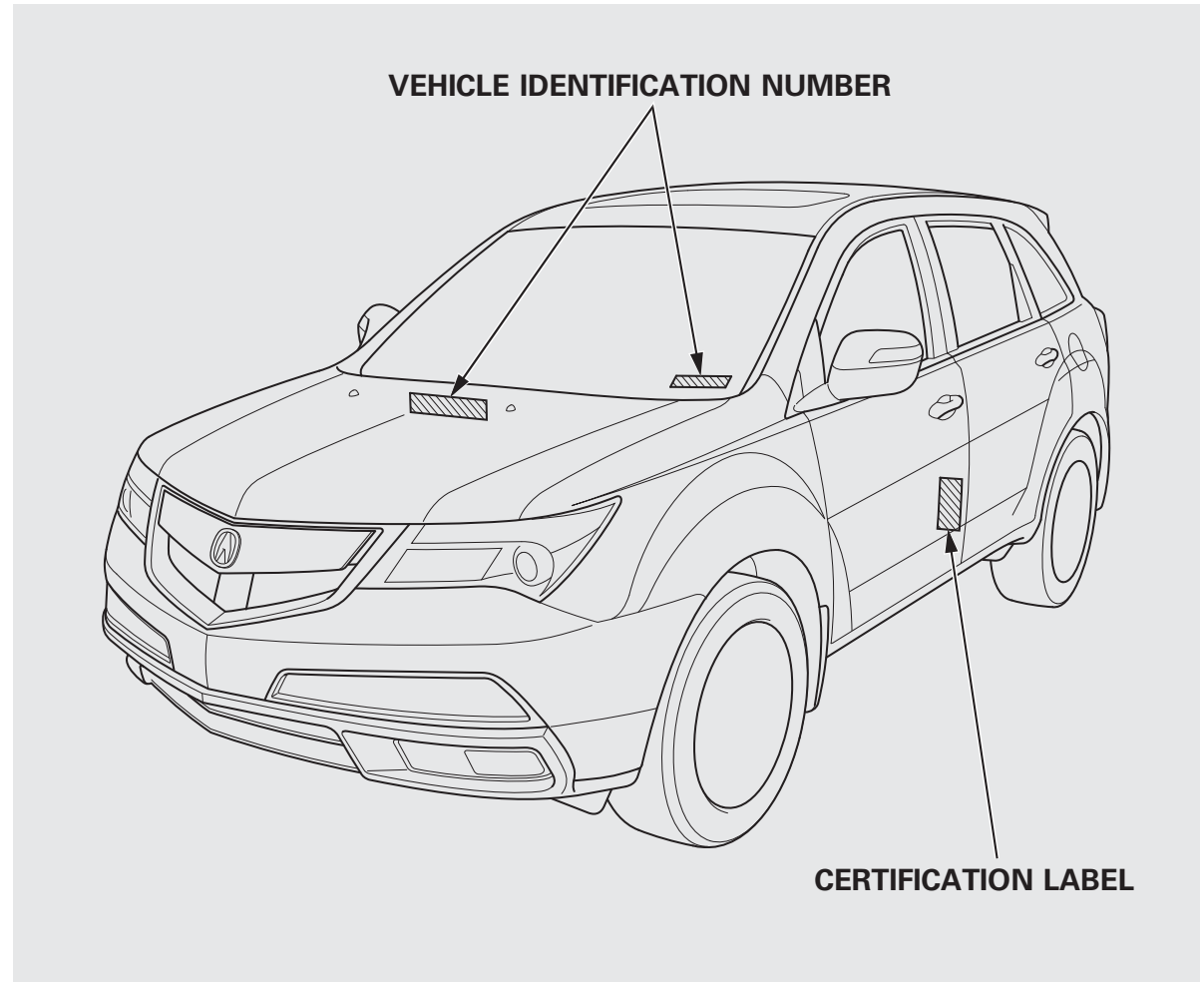

The engine number is stamped into the engine block. It is on the front.

The transmission number is on a label on top of the transmission.

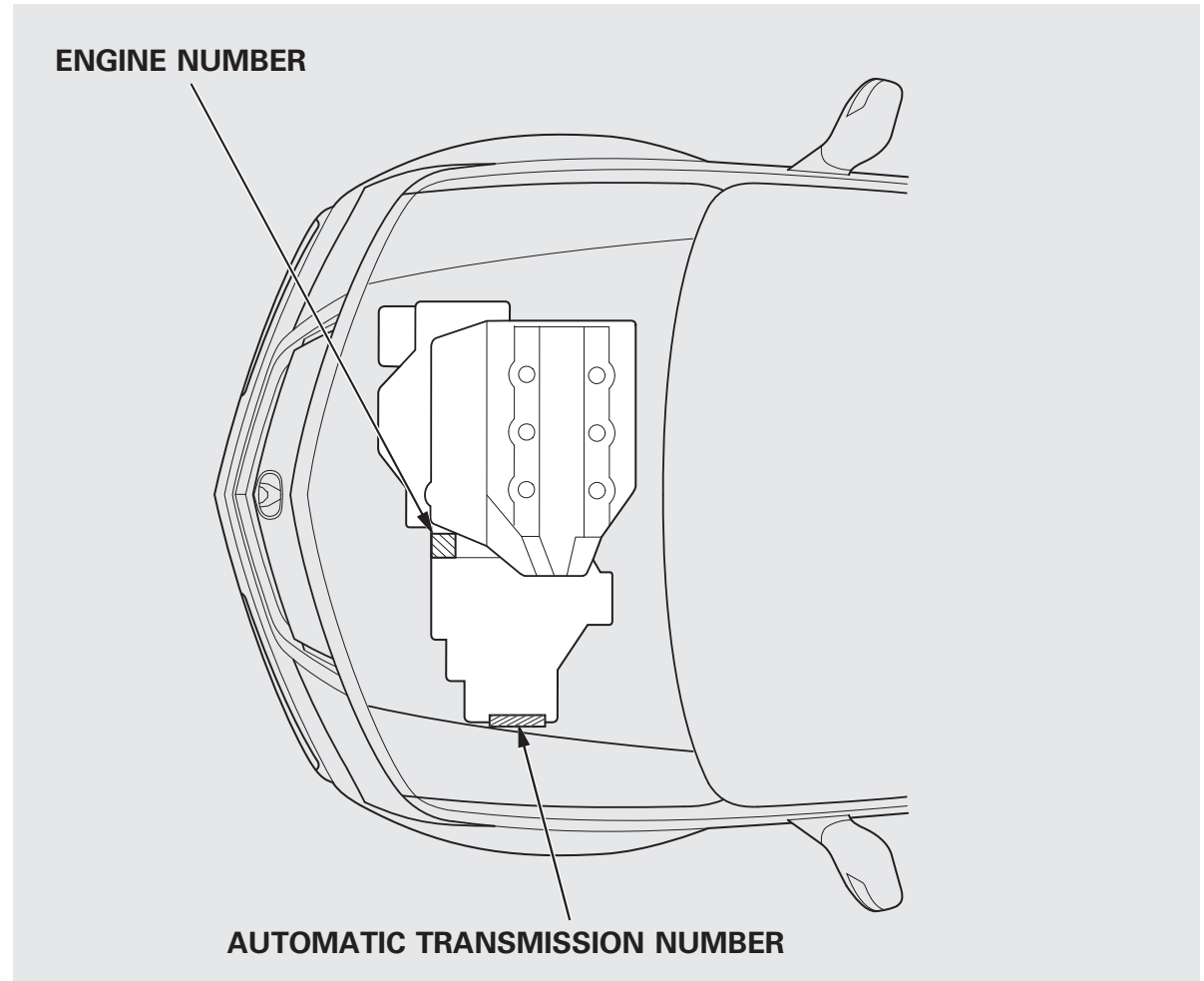

Specifications

Dimensions

Length		191.6 in (4,867 mm)
Width		78.5 in (1,994 mm)
Height		68.2 in (1,733 mm)
Wheelbase		108.3 in (2,750 mm)
Track	Front	67.7 in (1,720 mm)
	Rear	67.5 in (1,715 mm)

Weights

Gross vehicle weight rating	See the tire information label attached to the driver's doorjamb.
Gross combined weight* ¹ rating (GCWR)	10,053 lbs (4,560 kg)

*1: The GCWR must be reduced 2 percent for every 1,000 feet (305 meters) of elevation.

Air Conditioning

Refrigerant type	HFC-134a (R-134a)
Charge quantity	21.2–22.9 oz (600–650 g)
Lubricant type	ND-OIL 8

Seating Capacities

Total	7
Front	2
Second	3
Third	2

Capacities

Fuel tank		Approx. 21.00 US gal (79.5 L)
Engine coolant	Change* ¹	1.93 US gal (7.3 L)
	Total	2.43 US gal (9.2 L)
Engine oil	Change* ²	4.5 US qt (4.3 L)
	Including filter	
	Without filter	4.2 US qt (4.0 L)
	Total	5.3 US qt (5.0 L)
Automatic transmission fluid	Change	3.3 US qt (3.1 L)
	Total	8.5 US qt (8.0 L)
Rear differential fluid	Change	2.6 US qt (2.5 L)
	Total	3.0 US qt (2.8 L)
Transfer assembly fluid	Change	0.4 US qt (0.4 L)
	Total	0.4 US qt (0.4 L)
Windshield washer reservoir	U.S. vehicles	4.2 US qt (4.0 L)
	Canadian vehicles	6.1 US qt (5.8 L)

*1: Including the coolant in the reserve tank and that remaining in the engine
Reserve tank capacity:
0.18 US gal (0.7 L)

*2: Excluding the oil remaining in the engine

Lights

Headlights	High	60 W (HB3)
	Low* ¹	35 W (D2S)
Daytime running lights		60 W (HB3)
Front side marker lights		3 CP
Front turn signal lights		21 W (Amber)
Parking lights		3 CP
Stop/Tail lights		LED* ²
Side turn signal lights		LED* ²
Fog lights		55 W (H11)
Rear turn signal lights		21 W
Rear side marker lights		3 CP
Backup lights		18 W
High-mount brake light		LED* ²
License plate lights		3 CP
Tailgate lights		5 W
Vanity mirror lights		2 W
Door lights		3.4 W
Glove box light		1.4 W
Foot light		3.4 W

*1: The low beam headlights are high voltage discharged type. Replacement of a low beam headlight bulb should be performed by your dealer.

*2: Replacement of a light bulb should be done by your dealer.

Battery

Capacity	12 V — 65AH/5 HR
	12 V — 76AH/20 HR

Fuses

Interior	See page 571 or the fuse label attached to the inside of the fuse box lid.
Rear	See page 570 or the fuse label attached to the inside of the fuse box lid.
Under-hood	See page 569 and 570 or the fuse box cover.

Engine

Type	Water-cooled, 4-stroke SOHC VTEC V6 gasoline engine
Bore x Stroke	3.54 x 3.78 in (90.0 x 96.0 mm)
Displacement	223.5 cu-in (3,664 cm ³)
Compression ratio	11.2 : 1
Spark plugs	DENSO: SXU22HCR11S NGK: ILZKR7B11S

Alignment

Toe-in	Front	0.00 in (0.0 mm)
	Rear	0.08 in (2.0 mm)
Camber	Front	— 0° 30'
	Rear	— 0° 30'
Caster	Front	4° 12'

Specifications

Tires

Size	Front/Rear	255/55R18 105H* ¹ P255/50R19 103H* ²
	Spare	T165/80D17 104M
Pressure	Front/Rear	32 psi (220 kPa, 2.2 kgf/cm ²)
	Spare	60 psi (420 kPa, 4.2 kgf/cm ²)

*1: MDX, Technology Package, and U.S. Technology Package with Entertainment models

*2: U.S. Advance Package, Advance Package with Entertainment, and Canadian Elite Package models

DOT Tire Quality Grading (U.S. Vehicles)

The tires on your vehicle meet all U. S. Federal Safety Requirements. All tires are also graded for treadwear, traction, and temperature performance according to Department of Transportation (DOT) standards. The following explains these gradings.

Uniform Tire Quality Grading

Quality grades can be found where applicable on the tire sidewall between tread shoulder and maximum section width. For example:

Treadwear 200

Traction AA

Temperature A

All passenger car tires must conform to Federal Safety Requirements in addition to these grades.

Treadwear

The treadwear grade is a comparative rating based on the wear rate of the tire when tested under controlled conditions on a specified government test course. For example, a tire graded 150 would wear one and one-half (1 1/2) times as well on the government course as a tire graded 100. The relative performance of tires depends upon the actual conditions of their use, however, and may depart significantly from the norm due to variations in driving habits, service practices and differences in road characteristics and climate.

Traction

The traction grades, from highest to lowest, are AA, A, B, and C. Those grades represent the tire's ability to stop on wet pavement as measured under controlled conditions on specified government test surfaces of asphalt and concrete. A tire marked C may have poor traction performance.

Warning: The traction grade assigned to this tire is based on straight-ahead braking traction tests, and does not include acceleration, cornering, hydroplaning, or peak traction characteristics.

DOT Tire Quality Grading (U.S. Vehicles)

Temperature

The temperature grades are A (the highest), B, and C, representing the tire's resistance to the generation of heat and its ability to dissipate heat when tested under controlled conditions on a specified indoor laboratory test wheel. Sustained high temperature can cause the material of the tire to degenerate and reduce tire life, and excessive temperature can lead to sudden tire failure. The grade C corresponds to a level of performance which all passenger car tires must meet under the Federal Motor Vehicle Safety Standard No. 109. Grades B and A represent higher levels of performance on the laboratory test wheel than the minimum required by law.

Warning: The temperature grade for this tire is established for a tire that is properly inflated and not overloaded. Excessive speed, underinflation, or excessive loading, either separately or in combination, can cause heat buildup and possible tire failure.

The tires that came on your vehicle have a number of markings. Those you should be aware of are described below.

TIRE LABELING EXAMPLE

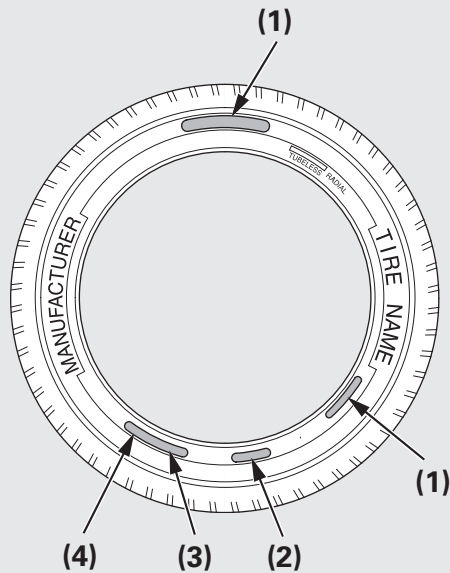

- (1) Tire Size
- (2) Tire Identification Number (TIN)
- (3) Maximum Tire Pressure
- (4) Maximum Tire Load

Tire Size

Whenever tires are replaced, they should be replaced with tires of the same size. Following is an example of tire size with an explanation of what each component means.

P255/50R19 103H

- P – Vehicle type (P indicates passenger vehicle).
- 255 – Tire width in millimeters.
- 50 – Aspect ratio (the tire's section height as a percentage of its width).
- R – Tire construction code (R indicates radial).
- 19 – Rim diameter in inches.

- 103 – Load index (a numerical code associated with the maximum load the tire can carry).
- H – Speed symbol (an alphabetical code indicating the maximum speed rating).

Tire Identification Number (TIN)

The tire identification number (TIN) is a group of numbers and letters that look like the following example. TIN is located on the sidewall of the tire.

DOT B97R FW6X 2202

- DOT – This indicates that the tire meets all requirements of the U.S. Department of Transportation.
- B97R – Manufacturer's identification mark.

CONTINUED

Tire Labeling

FW6X – Tire type code.

2202 – Date of manufacture.

└─── Year
└─── Week

Glossary of Tire Terminology

Cold Tire Pressure – The tire air pressure when the vehicle has been parked for at least three hours or driven less than 1 mile (1.6 km).

Load Rating – Means the maximum load that a tire is rated to carry for a given inflation pressure.

Maximum Inflation Pressure – The maximum tire air pressure that the tire can hold.

Maximum Load Rating – Means the load rating for a tire at the maximum permissible inflation pressure for that tire.

Recommended Inflation Pressure – The cold tire inflation pressure recommended by the manufacturer.

Treadwear Indicators (TWI) – Means the projections within the principal grooves designed to give a visual indication of the degrees of wear of the tread.

Tire Pressure Monitoring System (TPMS) – Required Federal Explanation

Each tire, including the spare (if provided), should be checked monthly when cold and inflated to the inflation pressure recommended by the vehicle manufacturer on the vehicle placard or tire inflation pressure label.

(If your vehicle has tires of a different size than the size indicated on the vehicle placard or tire inflation pressure label, you should determine the proper tire inflation pressure for those tires.)

As an added safety feature, your vehicle has been equipped with a tire pressure monitoring system (TPMS) that illuminates a low tire pressure telltale



when one or more of your tires is significantly under-inflated.

Accordingly, when the low tire pressure telltale illuminates, you should stop and check your tires as soon as possible, and inflate them to the proper pressure.

Driving on a significantly under-inflated tire causes the tire to overheat and can lead to tire failure. Under-inflation also reduces fuel efficiency and tire tread life, and may affect the vehicle's handling and stopping ability.

Please note that the TPMS is not a substitute for proper tire maintenance, and it is the driver's responsibility to maintain correct tire pressure, even if under-inflation has not reached the level to trigger illumination of the TPMS low tire pressure telltale.

Tire Pressure Monitoring System (TPMS) – Required Federal Explanation

Your vehicle has also been equipped with a TPMS malfunction indicator to indicate when the system is not operating properly. The TPMS malfunction indicator is combined with the low tire pressure telltale. When the system detects a malfunction, the telltale will flash for approximately one minute and then remain continuously illuminated. This sequence will continue upon subsequent vehicle start-ups as long as the malfunction exists.

When the malfunction indicator is illuminated, the system may not be able to detect or signal low tire pressure as intended.

TPMS malfunctions may occur for a variety of reasons, including the installation of replacement or alternate tires or wheels on the vehicle that prevent the TPMS from functioning properly.

Always check the TPMS malfunction telltale after replacing one or more tires or wheels on your vehicle to ensure that the replacement or alternate tires and wheels allow the TPMS to continue to function properly.

The burning of gasoline in your vehicle's engine produces several byproducts. Some of these are carbon monoxide (CO), oxides of nitrogen (NO_x), and hydrocarbons (HC). Gasoline evaporating from the tank also produces hydrocarbons. Controlling the production of NO_x, CO, and HC is important to the environment. Under certain conditions of sunlight and climate, NO_x and HC react to form photochemical "smog." Carbon monoxide does not contribute to smog creation, but it is a poisonous gas.

The Clean Air Act

The United States Clean Air Act* sets standards for automobile emissions. It also requires that automobile manufacturers explain to owners how their emissions controls work and what to do to maintain them. This section summarizes how the emissions controls work. Scheduled maintenance is on page 514.

* In Canada, Acura vehicles comply with the Canadian emission requirements, as specified in an agreement with Environment Canada, at the time they are manufactured.

Crankcase Emissions Control System

Your vehicle has a positive crankcase ventilation system. This keeps gasses that build up in the engine's crankcase from going into the atmosphere. The positive crankcase ventilation valve routes them from the crankcase back to the intake manifold. They are then drawn into the engine and burned.

Evaporative Emissions Control System

As gasoline evaporates in the fuel tank, an evaporative emissions control canister filled with charcoal adsorbs the vapor. It is stored in this canister while the engine is off. After the engine is started and warmed up, the vapor is drawn into the engine and burned during driving.

CONTINUED

Emissions Controls

Onboard Refueling Vapor Recovery

The onboard refueling vapor recovery (ORVR) system captures the fuel vapors during refueling. The vapors are adsorbed in a canister filled with activated carbon. While driving, the fuel vapors are drawn into the engine and burned off.

Exhaust Emissions Controls

The exhaust emissions controls include four systems: PGM-FI, ignition timing control, exhaust gas recirculation, and three way catalytic converter. These four systems work together to control the engine's combustion and minimize the amount of HC, CO, and NOx that come out the tailpipe. The exhaust emissions control systems are separate from the crankcase and evaporative emissions control systems.

PGM-FI System

The PGM-FI system uses sequential multiport fuel injection. It has three subsystems: air intake, engine control, and fuel control. The powertrain control module (PCM) uses various sensors to determine how much air is going into the engine. It then controls how much fuel to inject under all operating conditions.

Ignition Timing Control System

This system constantly adjusts the ignition timing, reducing the amount of HC, CO, and NOx produced.

Exhaust Gas Recirculation (EGR) System

The exhaust gas recirculation (EGR) system takes some of the exhaust gas and routes it back into the intake manifold. Adding exhaust gas to the air/fuel mixture reduces the amount of NOx produced when the fuel is burned.

Three Way Catalytic Converter

The three way catalytic converter is in the exhaust system. Through chemical reactions, it converts HC, CO, and NOx in the engine's exhaust to carbon dioxide (CO₂), nitrogen (N₂), and water vapor.

Replacement Parts

The emissions control systems are designed and certified to work together in reducing emissions to levels that comply with the Clean Air Act. To make sure the emissions remain low, you should use only new Acura replacement parts or their equivalent for repairs. Using lower quality parts may increase the emissions from your vehicle.

The emissions control systems are covered by warranties separate from the rest of your vehicle. Read your warranty manual for more information.

Three Way Catalytic Converter

The three way catalytic converter contains precious metals that serve as catalysts, promoting chemical reactions to convert the exhaust gasses without affecting the metals. The catalytic converter is referred to as a three-way catalyst, since it acts on HC, CO, and NOx. A replacement unit must be an original Acura part or its equivalent.

The three way catalytic converter must operate at a high temperature for the chemical reactions to take place. It can set on fire any combustible materials that come near it. Park your vehicle away from high grass, dry leaves, or other flammables.

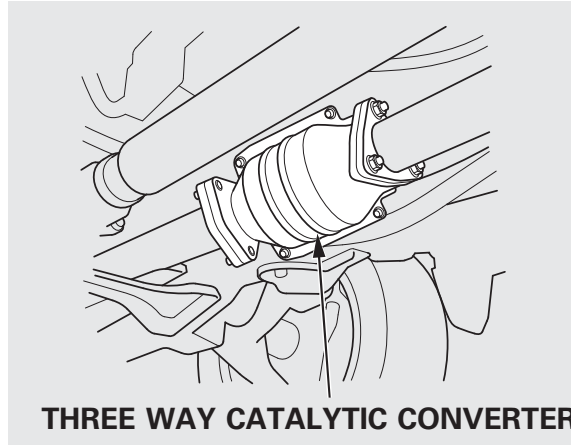

A defective three way catalytic converter contributes to air pollution, and can impair your engine's performance. Follow these guidelines to protect your vehicle's three way catalytic converter.

- Always use unleaded gasoline. Even a small amount of leaded gasoline can contaminate the catalyst metals, making the three way catalytic converter ineffective.

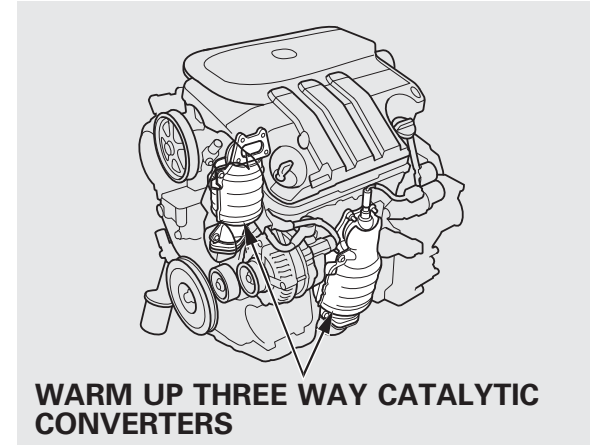

WARM UP THREE WAY CATALYTIC CONVERTERS

- Keep the engine well maintained.
- Have your vehicle diagnosed and repaired if it is misfiring, backfiring, stalling, or otherwise not running properly.

Emissions Testing

Testing of Readiness Codes

If you take your vehicle for an emissions test shortly after the battery has been disconnected or gone dead, it may not pass the test. This is because of certain “readiness codes” that must be set in the on-board diagnostics for the emissions systems. These codes are erased when the battery is disconnected, and set again only after several days of driving under a variety of conditions.

If the testing facility determines that the readiness codes are not set, you will be requested to return at a later date to complete the test. If you must get the vehicle retested within the next two or three days, you can condition the vehicle for retesting by doing the following.

1. Make sure the gas tank is nearly, but not completely, full (around 3/4).
2. Make sure the vehicle has been parked with the engine off for 6 hours or more.
3. Make sure the ambient temperature is between 40° and 95° F (4° and 35° C).
4. Without touching the accelerator pedal, start the engine, and let it idle for 20 seconds.
5. Keep the vehicle in Park. Increase the engine speed to 2,000 rpm, and hold it there until the temperature gauge rises to at least 1/4 of the scale (about 3 minutes).
6. Without touching the accelerator pedal, let the engine idle for 20 seconds.

7. Select a nearby lightly traveled major highway where you can maintain a speed of 50 to 60 mph (80 to 97 km/h) for at least 20 minutes. Drive on the highway in D. Do not use the cruise control. When traffic allows, drive for 90 seconds without moving the accelerator pedal. (Vehicle speed may vary slightly; this is okay.) If you cannot do this for a continuous 90 seconds because of traffic conditions, drive for at least 30 seconds, then repeat it two more times (for a total of 90 seconds).
8. Then drive in city/suburban traffic for at least 10 minutes. When traffic conditions allow, let the vehicle coast for several seconds without using the accelerator pedal or the brake pedal.
9. Make sure the vehicle has been parked with the engine off for 30 minutes.
If the testing facility determines the readiness codes are still not set, see your dealer.

Warranty and Client Relations

Client Service Information.....	594
Warranty Coverages	595
Reporting Safety Defects.....	596
Authorized Manuals.....	597

Client Service Information

Acura dealership personnel are trained professionals. They should be able to answer all your questions. If you encounter a problem that your dealership does not solve to your satisfaction, please discuss it with the dealership's management. The service manager or general manager can help. Almost all problems are solved in this way.

If you are dissatisfied with the decision made by the dealership's management, contact Acura Client Relations.

U.S. Owners:

American Honda Motor Co., Inc.
Acura Client Relations
Mail Stop 500-2N-7E
1919 Torrance Blvd.
Torrance, CA 90501-2746

Tel: (800) 382-2238

Canadian Owners:

Honda Canada Inc.
Acura Client Services
180 Honda Boulevard
Markham, ON
L6C 0H9

Tel: 1-888-9-ACURA-9

Fax: 1-877-939-0909

E-Mail: acura_cr@ch.honda.com

In Puerto Rico and the U.S. Virgin Islands:

Vortex Motor Corp.
Bella International
P.O. Box 190816
San Juan, PR 00919-0816

Tel: (787) 620-7546

When you call or write, please give us this information:

- Vehicle Identification Number (see page 576)
- Name and address of the dealer who services your vehicle
- Date of purchase
- Odometer reading of your vehicle
- Your name, address, and telephone number
- A detailed description of the problem
- Name of the dealer who sold the vehicle to you

U.S. Owners

Your new vehicle is covered by these warranties:

New Vehicle Limited Warranty – covers your new vehicle, except for the emissions control systems, and accessories, against defects in materials and workmanship.

Emissions Control Systems Defects Warranty and Emissions Performance Warranty – these two warranties cover your vehicle's emissions control systems. Time, mileage, and coverage are conditional. Please read your warranty booklet for exact information.

Seat Belt Limited Warranty – a seat belt that fails to function properly is covered by a limited warranty. Please read your warranty booklet for details.

Rust Perforation Limited Warranty – all exterior body panels are covered for rust-through from the inside for the specified time period with no mileage limit.

Accessory Limited Warranty – Acura accessories are covered under this warranty. Time and mileage limits depend on the type of accessory and other factors. Please read your warranty manual for details.

Replacement Parts Limited Warranty – covers all Acura replacement parts against defects in materials and workmanship.

Replacement Battery Limited Warranty – provides prorated coverage for a replacement battery purchased from your dealer.

Replacement Muffler Lifetime Limited Warranty – provides coverage for as long as the purchaser of the muffler owns the vehicle.

Restrictions and exclusions apply to all these warranties. Please read the 2012 Acura warranty information booklet that came with your vehicle for precise information on warranty coverages. Your vehicle's original tires are covered by their manufacturer. Tire warranty information is in a separate booklet.

Canadian Owners

Please refer to the 2012 warranty manual that came with your vehicle.

Reporting Safety Defects

In the US

If you believe that your vehicle has a defect which could cause a crash or could cause injury or death, you should immediately inform the National Highway Traffic Safety Administration (NHTSA) in addition to notifying American Honda Motor Co., Inc.

If NHTSA receives similar complaints, it may open an investigation, and if it finds that a safety defect exists in a group of vehicles, it may order a recall and remedy campaign. However, NHTSA cannot become involved in individual problems between you, your dealer, or American Honda Motor Co., Inc.

To contact NHTSA, you may call the Vehicle Safety Hotline toll-free at 1-888-327-4236 (TTY: 1-800-424-9153); go to <http://www.safercar.gov>, or write to: Administrator, NHTSA, 1200 New Jersey Avenue, SE., Washington, DC 20590.

You can also obtain other information about motor vehicle safety from <http://www.safercar.gov>.

In Canada

If you believe that your vehicle has a defect which could cause a crash or could cause injury or death, you should immediately inform Honda Canada Inc. and you may also inform Transport Canada.

If Transport Canada receives similar complaints, it may open an investigation, and if it finds that a safety defect exists in a group of vehicles, it may lead to a recall and remedy campaign. However, Transport Canada cannot become involved in individual problems between you, your dealer, or Honda Canada Inc.

To contact Transport Canada's Defect Investigations and Recalls Division, you may call 1-800-333-0510. For more information on reporting safety defects or about motor vehicle safety, go to <http://www.tc.gc.ca/roadsafety>.

Purchasing Factory Authorized Manuals (U.S. only)

The publications shown below can be purchased from Helm Incorporated. You can order by phone or online:

- Call Helm Inc. at 1-800-782-4356 (credit card orders only)
- Go online at *www.helminc.com*

If you are interested in other years or models, contact Helm Inc. at 1-800-782-4356.

Publication Form Number	Form Description
61STX05	2010-2012 Acura MDX Service Manual
61STX03EL	2010-2011 Acura MDX Electrical Troubleshooting Manual
61STX30	2008 Acura MDX Body Repair Manual
31STX650	2012 Acura MDX Owner's Manual
31STX850	2012 Acura MDX Navigation System Owner's Manual
31STXM50	2012 Acura MDX Maintenance Journal
31STXQ50	2012 Acura MDX Advance Technology Guide
ACU-R	Order Form for Previous Years Indicate Year and Model Desired

Service Manual:

Covers maintenance and recommended procedures for repair to engine and chassis components. It is written for the journeyman mechanic, but it is simple enough for most mechanically inclined owners to understand.

Electrical Troubleshooting Manual:

Complements the Service Manual by providing in-depth troubleshooting information for each electrical circuit in your vehicle.

Body Repair Manual:

Describes the procedures involved in the replacement of damaged body parts.

A

Accessories and Modifications 431

ACCESSORY (Ignition Key Position) 139

Accessory Power Sockets 177

AC Power Outlet 178

Active Damper System 484

Active Head Restraints 152

AcuraLink® (U.S. models only) 402

Adaptive Cruise Control (ACC) 348

Additives, Engine Oil 518

Adjusting the Steering Wheel ... 134

Advanced Airbags 31

Airbag (SRS) 10, 27

Air Conditioning System 182

 Rear A/C Control 187

Air Outlets (Vents) 189

Air Pressure, Tires 540, 541

Alcohol in Gasoline 422

Antifreeze 520

Anti-lock Brakes (ABS)

 Indicator 70, 462

 Operation 461

Anti-theft, Audio System 308

Anti-theft Steering Column Lock 139

Audio System 192, 212

Automatic Climate Control 183

Automatic Lighting Off

 Feature 131

Automatic Seat Belt Tensioners ... 23

Automatic Speed Control 345

Automatic Transmission 443

 Capacity, Fluid 578

 Checking Fluid Level 523

 Driving with the Paddle Shifters 447

 Shifting 444

Shift Lever Position

 Indicators 443

 Shift Lever Positions 444

 Shift Lock Release 446

Auxiliary Input Jack 307

B

Battery

 Charging System

 Indicator 69, 562

 Jump Starting 558

 Maintenance 547

 Specifications 579

Before Driving 421

Belts, Seat 9, 21

Beverage Holders 174

Blind Spot Information System (BSI) 476

Bluetooth® Audio 298

Bluetooth® HandsFreeLink® (Models with navigation system) 383

Bluetooth® HandsFreeLink® (Models without navigation system) 365

Booster Seats 58

Index

Brakes

Anti-lock Brakes (ABS)	461
Break-in, New Linings	422
Fluid	525
Parking	164
System Design	461
System Indicator	69, 564
Wear Indicators	461
Braking System	460
Break-in, New Vehicle	422
Brightness Control, Instruments	133
Bulb Replacement	
Back-up Lights	531, 532
Front Parking Lights	529
Front Side Marker Lights	529
Headlights	527
High-mount Brake Light	533
Rear Bulbs	531
Rear License Plate Lights	533
Specifications	579
Taillights	531
Bulbs, Halogen	527

C

Capacities Chart	578
Carbon Monoxide Hazard	61
Cargo	433
Cargo Hooks	437
Cargo, How to Carry	433
Carrying Cargo	433
CAUTION, Explanation of	iv
CD Care	247
CD Error Messages	246
CD Player	235
Certification Label	576
Chains, Tires	546
Changing a Flat Tire	551
Changing Oil	
How to	518
When to	507
Charging System	
Indicator	69, 562
Checklist, Before Driving	441
Childproof Door Locks	141
Child Safety	40
Booster Seats	58
Child Seats	45, 46, 48

Important Safety Reminders	44
Infants	45
Larger Children	57
LATCH	50
Risks with Airbags	41
Small Children	46
Tethers	54
Warning Labels	42
Where Should a Child Sit?	41
Child Seats	40, 48
LATCH Anchorage Points	50
Tether Anchorage Points	54
Cleaning the Seat Belts	534
Client Service Information	594
Climate Control System	182
Clock	309
Code, Audio System	308
CO in the Exhaust	61, 587
Cold Weather, Starting in	442
Collision Mitigation Braking System™ (CMBS™)	463
Compact Spare Tire	550
Compass Operation	342
Console Compartment	175
Consumer Information	594
Controls, Instruments and	65

Coolant
 Adding 520
 Checking 427
 Proper Solution 520
 Temperature Gauge 78
 Crankcase Emissions Control
 System 587
 Cruise Control Indicator 75
 Cruise Control Operation 345
 Cruise Main Indicator 75
 Cup Holders 174
 Customize Settings 90

D

DANGER, Explanation of iv
 Dashboard 3, 66
 Daytime Running Lights 130
 Dead Battery 558
 Defogger, Rear Window 132
 Defrosting the Windows 186
 Dimensions 578
 Dimming the Headlights 128
 Dipstick
 Automatic Transmission 523

Engine Oil 427
 Directional Signals 71, 128
 Disc Brake Wear Indicators 461
 Disc Care 247
 Disc Changer 203
 Disc Changer Error
 Messages 211
 Disc Player 203, 235
 Disc Player Error Messages 246
 Disposal of Used Oil 519
 Doors
 Childproof Door Locks 141
 Indicator 12
 Locking and Unlocking 140
 Lockout Prevention 141
 DOT Tire Quality Grading (U.S.
 Vehicles) 581
 Driver and Passenger Safety 5
 Driving 439
 Economy 428
 Driving Guidelines 440
 Driving Position Memory
 System 168
 Driving with the Paddle
 Shifters 447
 Dust and Pollen Filter 534

DVD Player 313
 DVD Player Error Messages 337

E

Economy, Fuel 428
 Emergencies on the Road 549
 Battery, Jump Starting 558
 Brake System Indicator 69, 564
 Changing a Flat Tire 551
 Charging System
 Indicator 69, 562
 Checking the Fuses 566
 Driving with a Flat Tire 551
 Hazard Warning Flashers 132
 Jump Starting 558
 Low Oil Pressure
 Indicator 69, 562
 Malfunction Indicator
 Lamp 69, 563
 Opening the Fuel Fill Door
 Manually 572
 Overheated Engine 560
 Towing 572
 Emergency Brake 164

CONTINUED

Index

Emergency Flashers	132
Emergency Towing	572
Emissions Controls	587
Emissions Testing	590
Engine	
Adding Engine Coolant	520
Check Starting System	443
Coolant Temperature Gauge	78
If it Won't Start	557
Malfunction Indicator	
Lamp	69, 563
Oil Life Indicator	507
Oil Pressure Indicator	69, 562
Oil, What Kind to Use	517
Overheating	560
Specifications	579
Speed Limiter	446
Starting	442
Engine Coolant	520
Ethanol in Gasoline	422
Evaporative Emissions	
Controls	587
Exhaust Fumes	61
Exhaust Gas Recirculation	
System	588

Expectant Mothers, Use of Seat	
Belts by	19

F

Fan, Interior	185
Features	181
Filters	
Dust and Pollen	534
Oil	518
Flashers, Hazard Warning	132
Flat Tire, Changing a	551
Floor Mats	535
Fluids	
Automatic Transmission	523
Brake	525
Location	515
Power Steering	526
Windshield Washer	522
FM Stereo Radio	
Reception	303
Fog Lights	130
Folding the Second Seat	153
Folding the Third Seat	154
Four-way Flashers	132

Front Airbags	10, 30
Front Seat	149
Adjusting	149
Air Ventilation	158
Heaters	157
Fuel	422
Economy	428
Fill Door and Cap	424
Gauge	78
Low Fuel Indicator	77
Octane Requirement	422
Opening the Fuel Fill Door	
Manually	572
Reserve Indicator	77
Tank, Filling the	424
Tighten Fuel Cap	425
Fuel Economy	428
Fuses, Checking the	566

G

Gas Mileage, Improving	429
Gasoline	422
Gauge	78
Low Fuel Indicator	77

Octane Requirement 422
 Tank, Refueling 424
 Gas Station Procedures 424
 Gauges
 Engine Coolant Temperature ... 78
 Fuel 78
 Speedometer 78
 Tachometer 78
 GAWR (Gross Axle Weight Rating) 488
 GCWR (Gross Combined Weight Rating) 488
 Gearshift Lever Positions
 Automatic
 Transmission 443, 444
 Glove Box 175
 Gross Axle Weight Rating (GAWR) 488
 Gross Vehicle Weight Rating (GVWR) 488
 GVWR (Gross Vehicle Weight Rating) 488

H

Halogen Headlight Bulbs 527
 Hazard Warning Flashers 132
 Headlights 128
 Aiming 527
 Automatic Lighting Off 131
 Daytime Running Lights 130
 High Beam Indicator 74
 High Beams, Turning on 128
 Lights On Indicator 74
 Low Beams, Turning on 128
 Reminder Chime 129
 Replacing Halogen Bulbs 527
 Turning on 128
 Washers 127
 Headphones 338
 Head Restraints 150
 Heated Mirror 167
 Heaters, Seats 157
 Heating and Cooling 182
 High Altitude, Starting at 442
 High Beam Lever 128, 129
 High-Low Beam Switch 128

HomeLink® Universal
 Transceiver 363
 Hood, Opening and Closing
 the 426
 Horn 4, 125

I

Identification Number,
 Vehicle 576
 Ignition
 Keys 136
 Switch 139
 Timing Control System 588
 Immobilizer System 138
 Important Safety Precautions 6

Index

Indicators, Instrument Panel	67	Passenger Airbag Off	37	iPod®	278
ABS (Anti-lock Brake)	70, 462	Seat Belt Reminder	21, 68	iPod® Error Messages	286
Active Damper System	77, 484	Security System	77		
Adaptive Cruise Control		SH-AWD®	73	J	
(ACC)	75	Side Airbag Off	36, 70	Jacking up the Vehicle	551
A/T Temp	72	SRS	36, 70	Jack, Tire	551
Blind Spot Information System		System Message	73, 86	Jump Starting	558
(BSI)	76	Tire Pressure Monitor	72		
Brake (Parking and Brake		Turn Signal and Hazard		K	
System)	69, 564	Warning	71	Keys	136
Charging System	69, 562	VSA OFF	71		
Collision Mitigation Braking		VSA System	71	L	
System™	75	Individual Map Lights	171	Label, Certification	576
Cruise Control	75	Infant Restraint	45	Lane Change, Signaling	128
Cruise Main	75	Infant Seats	45	Lap/Shoulder Belt	16, 22
Door and Tailgate Open	76	Tether Anchorage Points	54	LATCH Anchorage System	50
Fog Lights	74	Inflation, Proper Tire	540	Lights	
High Beam	74	Inside Mirror	165	Indicator	67
Key (Immobilizer System)	74	Inspection, Tire	542	Interior	170
Lights On	74	Installing a Child Seat	49	Parking	128
Low Fuel	77	Instrument Panel	67	Turn Signal	128
Low Oil Pressure	69, 562	Instrument Panel Brightness	133		
Low Tire Pressure	72	Instruments and Controls	65		
Maintenance Minder™	507	Interface Dial	212		
Malfunction Indicator		Interior Lights	170		
Lamp	69, 563	Introduction	i		

Load Limit 434, 487
 LOCK (Ignition Key Position) ... 139
 Locks
 Anti-theft Steering Column 139
 Childproof Door 141
 Fuel Fill Door 424
 Glove Box 175
 Lockout Prevention 141
 Tailgate 141, 142
 Low Coolant Level 427
 Lower Anchors 50
 Low Fuel Indicator 77
 Low Oil Pressure
 Indicator 69, 562
 Lubricant Specifications Chart ... 578
 Luggage, Storing (cargo) 433

M

Maintenance 505
 Main Items and Sub Items 511
 Minder 507
 Owner's Maintenance
 Checks 513
 Safety 506

Schedule 514
 Malfunction Indicator
 Lamp 69, 563
 Memory, Driving Position 168
 Message Display 86
 Message Indicator 73
 Meters, Gauges 78
 Methanol in Gasoline 422
 Mirrors, Adjusting 166
 Modifications 432
 Modifying Your Vehicle 432
 Moonroof 163
 Multi-Information Display 79

N

Neutral Gear Position 445
 New Vehicle Break-in 422
 NOTICE, Explanation of i
 Numbers, Identification 576

O

Octane Requirement,
 Gasoline 422

Odometer 81
 Odometer, Trip 81
 Off-Highway Driving
 Guidelines 500
 Oil
 Change, How to 518
 Change, When to 507
 Checking Engine 427
 Life, Engine 507
 Pressure Indicator 69, 562
 Selecting Proper Viscosity
 Chart 517
 ON (Ignition Key Position) 139
 Outside Mirrors 166
 Outside Temperature 82
 Overheating, Engine 560
 Owner's Maintenance Checks 513
 Oxygenated Fuels 422

P

Panel Brightness Control 133
 Park Gear Position 444
 Parking 454
 Parking Brake 164

CONTINUED

Reporting Safety Defects 596
 Reserve Tank, Engine
 Coolant 427, 520
 Restraint, Child 40
 Reverse Gear Position 445
 Rotation, Tire 544

S

Safety Belts 9, 21
 Safety Defects, Reporting 596
 Safety Features 8
 Airbags 10, 27
 Door Locks 12
 Head Restraints 15
 Seat Belts 9, 16, 21
 Seats & Seat-Backs 14, 15
 Safety Labels, Location of 62
 Safety Messages iv
 Seat Belt e-pretensioners 24
 Seat Belts 9, 21
 Additional Information 21
 Advice for Pregnant Women 19
 Automatic Seat Belt
 Tensioners 23

Cleaning 534
 e-pretensioner 24
 Lap/Shoulder Belt 16, 22
 Maintenance 25
 Reminder Indicator and
 Beeper 21, 68
 System Components 21
 Use During Pregnancy 19
 Wearing a Lap/Shoulder
 Belt 16, 22
 Seat Heaters and Seat
 Ventilation 158
 Seats 149
 Adjusting the Second Seat 153
 Air Ventilation 158
 Folding the Second Seat 153
 Folding the Third Seat 154
 Head Restraints 150
 Heaters 157
 Position Memory 168
 Third Row Access 154
 Seats, Adjusting the 149
 Security System 341
 Security System Indicator 77
 Sensors
 Driver's Seat Position Sensor ... 31

Front Passenger's Weight
 Sensors 31
 Impact Sensors 27
 Serial Number 576
 Service Intervals 507
 Service Station Procedures 424
 SH-AWD® 452
 Indicator 73
 Shifting the Automatic
 Transmission 444
 Shift Lever Position Indicators ... 443
 Shift Lock Release 446
 Side Airbags 33
 How the Side Airbag Off
 Indicator Works 36
 How Your Side Airbags Work .. 33
 Side Curtain Airbags 35
 How Your Side Curtain Airbags
 Work 35
 Side Marker Lights, Bulb
 Replacement in 529
 Signaling Turns 71
 Snow Tires 546
 Sound System 192, 212

CONTINUED

Index

Spare Tire 550
 Inflating 540, 550
 Specifications 580
Spark Plugs 579
Specifications 578
Speed Control 345
Speed Limiter 446
Speedometer 78
SRS, Additional Information 27
 Additional Safety Precautions ... 39
 Airbag Service 38
 Airbag System Components 27
 How the Side Airbag Off
 Indicator Works 36
 How the SRS Indicator Works .. 36
 How Your Front Airbags
 Work 30
 How Your Side Airbags Work .. 33
 How Your Side Curtain Airbags
 Work 35
SRS Indicator 36, 70
START (Ignition Key
 Position) 139
Starting the Engine 442
 Auto Control Mode 442

 In Cold Weather at High
 Altitude 442
 With a Dead Battery 558
State Emissions Testing 590
Steam Coming from Engine 560
Steering Wheel
 Adjustments 134
 Anti-theft Column Lock 139
 Buttons 305, 345
 Position Memory 168
Stereo Sound System 192, 212
Storage Compartment 175
Storing Your Vehicle 548
Sunglasses Holder 176
Sun Visor 176
Super Handling-All Wheel Drive™
 (SH-AWD®) System 452
Supplemental Restraint
 System 10, 27
 Servicing 38
 SRS Indicator 36, 70
 System Components 27
Synthetic Oil 518

T

Tachometer 78
Tailgate 141
 Open Indicator 76
 Opening the 141
 Power 142
Taillights, Changing Bulbs in 531
Taking Care of the
 Unexpected 549
Technical Descriptions
 DOT Tire Quality Grading (U.S.
 Vehicles) 581
 Emissions Control Systems 587
 Three Way Catalytic
 Converter 589
 Tire Labeling 583
 Tire Pressure Monitoring System
 (TPMS) – Required Federal
 Explanation 585
Temperature Gauge 78
Temperature, Inside Sensor 191
Temperature, Outside 82
Tensioners, Seat Belts 23
Tether Anchorage Points 54

Theft Protection, Radio 308
 Three Way Catalytic Converter 589
 Tilt/Telescopic Steering Wheel 134
 Timing Belt 526
 Tire Chains 546
 Tire, How to Change a Flat 551
 Tire Information 583
 Tire Labeling 583
 Tire Pressure Monitoring System (TPMS) 455, 585
 Low Tire Pressure Indicator 72, 455
 Tire Pressure Monitor 83, 456
 Tires 540
 Air Pressure 541
 Checking Wear 542
 Compact Spare 550
 DOT Tire Quality Grading (U.S. Vehicles) 581
 Inflation 540
 Inspection 542
 Labeling 583
 Maintenance 544
 Pressure Monitoring System ... 455

Replacing 544
 Rotating 544
 Snow 546
 Specifications 580
 Tire Chains 546
 Tools, Tire Changing 551
 Towing
 A Trailer 487
 Emergency Wrecker 572
 Equipment and Accessories ... 492
 Trailer Loading 488
 Trailer Towing Tips 496
 Weight Limit 487
 TPMS (Tire Pressure Monitoring System) 455
 Required Federal Explanation 585
 Trailer Stability Assist 498
 Transmission
 Checking Fluid Level 523
 Identification Number 576
 Shifting the Automatic 444
 Treadwear 542
 Trip Computer 84
 Trip Meter 81
 Turn Signals 71

U

Unexpected, Taking Care of the 549
 Uniform Tire Quality Grading 581
 Unleaded Gasoline 422
 USB Flash Memory Device Error Messages 297
 Used Oil, How to Dispose of 519
 Using the Paddle Shifters in the D position (D-Paddle Shift Mode) 447
 Using the Paddle Shifters in the S position (Sequential Shift Mode) 449

V

Vanity Mirror 177
 Vehicle Capacity Load 434
 Vehicle Dimensions 578
 Vehicle Identification Number ... 576

Index

Vehicle Stability Assist (VSA)	
System	473
VSA OFF Button	474
VSA OFF Indicator	71
VSA System Indicator	71
Vehicle Storage	548
Ventilation	189
VIN	576
Viscosity, Oil	517

W

WARNING, Explanation of	iv
Warning Labels, Location of	62
Warranty Coverages (U.S. only)	595
Washer, Windshield	
Checking the Fluid Level	522
Operation	126
Wheels	
Adjusting the Steering	134
Alignment and Balance	544
Aluminum Alloy Wheels	546
Cleaning	546
Compact Spare	550

Wrench, Nut	551
Windows	
Auto Reverse	160
Operating the Power	160
Rear, Defogger	132
Windshield	
Cleaning	126
Defroster	186
Washers	126, 522
Wipers, Windshield	
Changing Blades	536
Operation	126
Rear Windshield Wiper and Washer	127
Worn Tires	542
Wrecker, Emergency Towing	572

X

XM [®] Radio	197, 226
-----------------------------	----------

Service Information Summary

Gasoline:

Premium unleaded gasoline, pump octane number of 91 or higher.

Fuel Tank Capacity:

21.00 US gal (79.5 L)

Recommended Engine Oil:

API Premium grade 5W-20 detergent oil (see page 517).

Oil change capacity (including filter):

4.5 US qt (4.3 L)

Automatic Transmission Fluid:

Acura ATF DW-1 (automatic transmission fluid) (see page 524).

Rear Differential Fluid:

Use Acura All-Wheel Drive Fluid (DPSF) only.

Capacity:

SH-AWD differential case

2.6 US qt (2.5 L)

Transfer Assembly Fluid:

SAE 90 or SAE 80W-90 viscosity hypoid gear oil, API service classified GL4 or GL5 only.

Power Steering Fluid:

Acura Power Steering Fluid preferred, or another brand of power steering fluid as a temporary replacement. Do not use ATF (see page 526).

Brake Fluid:

Honda Heavy Duty Brake Fluid DOT 3 preferred, or a DOT 3 or DOT 4 brake fluid as a temporary replacement (see page 525).

Tire Pressure (measured cold):

Front/Rear:

32 psi (220 kPa, 2.2 kgf/cm²)

Compact Spare Tire:

60 psi (420 kPa, 4.2 kgf/cm²)